



MAZDA MX-5 30TH ANNIVERSARY

PRESS KIT
February 2019

INTRODUCTION



It has been 30 years since the Mazda MX-5 made its debut at the Chicago Auto Show. Thanks to an avid group of fans based all over the world, it's still with us, and as popular as ever.

It hasn't always been plain sailing, of course. Over three decades ago, our team members set out to create a car that anyone could enjoy in any scenario, which is easier said than done. Hard work and dedication beyond the call of duty led to the production of a small vehicle that reignited the passion the lightweight sportscar (LWS) had once enjoyed in a more carefree era. Our loyal customers then guided us through its evolution.

Over 1,000,000 MX-5s have been made so far, proving the car's appeal beyond any doubt. But we will not rest on our laurels. With the Jinba-ittai philosophy that gave birth to the original roadster firmly in mind, it's our intention to keep refining the model, constantly raising the bar to provide a vehicle that delivers well above expectations – a car that makes everyone happy...

Mazda Motor Corporation
February 2019

だれもが、しあわせになる。

街の通りを、はじめて見る小さなスポーツカーが、機を掛けてそれは元気に走っていく。セダンの男が振り返る。歩道をいく女性が立ち止まる。見慣れた街の風景が、いっぺんに華やか、2人しか乗れないし、バゲッジもそうは積めないし、ひよつとすると、人とは少し違って見えるかもしれないけれど、走らせる楽しさは、これがいちばん。ドライバーとスポーツカーのそんな軽やかな気分が、きつと、だれもの心をときめかせるのだらう。ユーノス ロードスター。基本は、小振りのオープンボディ、タイトな2シーター、FR、機械であることを超え、心の通いあった馬を操るように駆ける「人馬一体」の楽しさを純粋培養した、新時代のライトウェイトスポーツ。お願ひするのは、人とクルマの新しいときめきを創造するまったく新しいカーチャネル「ユーノス」。このクルマを手に入れるほんの少しの勇気を持って、きつと、だれもが、しあわせになる。

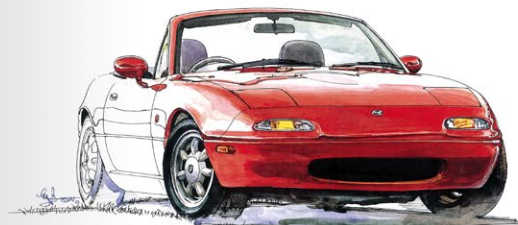

First Japanese brochure in 1989 quote the MX-5 a car that makes everyone happy.

*Roadster" is a general noun used to refer to an open top sports car. Mazda registered it as a trademark car name.

*"MX" is a symbol that signifies a sports car equipped with Mazda's reciprocating engine,

*"Miata" is an old German word meaning "reward."

Introduction	P1
Before Dawn	P3 - P8
First Generation	P9 - P13
Second Generation	P14 - P17
Third Generation	P18 - P22
Fourth Generation	P23 - P26
Production Line	P27
Photo Gallery	P28
Special Editions	P29 - P32
Show Cars	P33 - P34
M2 Incorporated	P35 - P36
Motorsports	P37 - P38
Fan Events	P39
World Premiere	P40
PR Events	P41
Awards	P42
Restoration	P43 - P44
Specifications	P45 - P48
Dimensions	P49 - P51
Statistics	P52
Chronology	P53 - P54

As a breed, the lightweight sportscar (LWS) had been around for decades, but Mazda gave it a new lease of life in the early 1980s. For the Japanese company, the definitive LWS had to have an open body with a tight cockpit space, perfect weight distribution, a double-wishbone suspension, and a certain Jinba-ittai element. This is the story, beginning with a chance comment from an American motoring writer to a man who would soon after become Mazda's President, leading up to the birth of the MX-5 in 1989.

Prelude

In the late 1970s, Bob Hall embarked on a new career as a motor journalist, working for the American magazine, Motor Trend. As a teenager, he'd spent a lot of time in Japan, so had a good grasp of the Japanese language, enabling him to also act as the LA correspondent for Motor Fan, a Japanese car magazine.

Hall had been surrounded by interesting automobiles all his life. His father was a 'car guy' of the highest order, running European machines from likes of MG, Triumph, Austin-Healey and Alfa Romeo – the purest forms of the light and simple open-top sportscar. But the era Hall found himself in as a young writer was killing off vehicles like this, with emissions and safety concerns grabbing the headlines. Indeed, there was even talk of banning convertibles altogether.

The Japanese were quick to react to these changing times, fielding reliable and economical machines that the Americans welcomed with open arms. Hall witnessed the shift first-hand, and came to admire the way Mazda persisted with sporting models powered by the rotary engine. He couldn't help but think how nice it would be to have a car that would blend Japanese technology and reliability with the fun experience that the British sportscars of yore provided.

Chalkboard Meeting

On 16 April 1979, Hall had the opportunity to visit the Mazda head office in Hiroshima. He was able to tell Kenichi Yamamoto (then head of R&D) about his dream automobile, sketching a drawing on a chalkboard and adding notes as he went along, explaining how easy it would be to create a convertible using components from the then-current Familia (also known as the 323 or GLC), which had a front-engine, rear-wheel drive (FR) layout.

Following the meeting, Hall had dinner with Yamamoto, but there was no mention of the LWS. He didn't give up, though, and suggested Yamamoto should try a Triumph Spitfire one day. Eventually, the Japanese engineer drove it on the picturesque roads around Hakone. The rest, as they, is history...

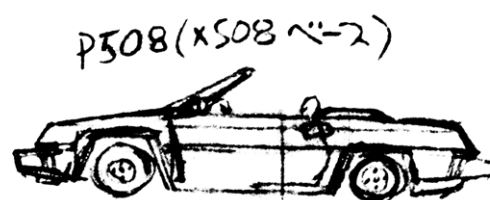

Yamamoto's Thoughts On Automobile Culture

Kenichi Yamamoto became Mazda's President in the spring of 1984. In his 1985 New Year message to the workforce, he noted two key points. Firstly, that a car was more than just a tool, it was something that enriched the customer's spirit. And secondly, a Mazda should always possess a functional beauty. This philosophy was passed down, and would shine through during the development of the new roadster. Indeed, the MX-5 could be classed as the perfect symbol of Yamamoto's way of thinking.



Early Development: The OGG Project

The true birth of the MX-5 project came about via the so-called OGG program. Mazda's main vehicles in Japan in the pre-Roadster days were the Familia (323), Capella (626), Luce (929), RX-7 and Bongo minivan. These were classed as 'On-Line' machines, but it was realized that additional models were needed to increase market share and penetrate other market areas.

Fresh, attractive products with a distinctive character were a must, naturally, and the OGG project would be used to channel new ideas through to a prototype stage. OGG stood for 'Off-Line Go-Go', with the off-line part signifying an experimental element, while the latter part expresses the Japanese number 55, as any projects raised in this new program had to have a minimum 55% chance of success as a production model to be progressed. It was a sensible way of allowing creativity whilst keeping things realistic.

Beginning in November 1983, a list was drawn up, highlighting

the need for a small 660cc model, a utility van, and possibly a lightweight sports car to slot in beneath the RX-7. The Carol kei-car was born as a result, along with the highly-successful Mazda MPV, and an open car that would take the world by storm – the MX-5.

The trend for sports cars at that time was excess – increases in power, increases in body size, and increases in price. There was still a requirement for smaller, lower priced machines, especially in places like California, but compact cars were rapidly moving toward FF layouts, making the production of traditional FR sports cars all the more difficult to justify. Small coupes from Japan were already starting to fill the gap, but Mazda would have its own concept for what the ideal LWS should be, thoughts being focused by an internal competition that would decide which route Mazda would take for its future two-seater sports car – the choice coming down to closed FF and MR models, or an FR convertible.

Progress

The FF and MR coupes were tackled by Mazda's Tokyo studio, while the FR convertible proposal was handled by the MANA (now known as MRA) team in the States. The full-scale models went through two rounds of judging in 1984 and, backed up by a video presentation focusing on the thoughts of Bob Hall, Tom Matano and Shigenori Fukuda (who was the boss of Mazda's American planning and research arm at the time) and feedback from owners and enthusiasts at a clinic held in Pasadena, it was the MANA design that ultimately got the nod.

This original design had a much sharper profile than the production model, but the lines were already starting to show through, and the detachable hardtop added a practical note that appealed to those attending the presentation. Another plus point was the fact that by adopting an FR layout, Mazda wasn't simply following the crowd – it was staying true to its philosophy of making unique products, and it would be a perfect stablemate for the rotary-engined RX-7.

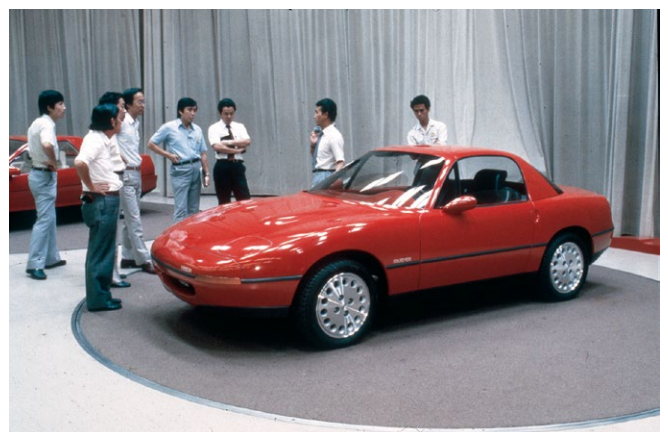

Santa Barbara Adventure

With the convertible idea approved, the concept was set in stone, calling for a front-engined rear-wheel drive sportscar that was steeped in LWS tradition, whilst employing the very latest technology. But there was a problem. Mazda was so tied-up with other work, there simply wasn't the staff available to move the open two-seater project forward. As a result, the company approached IAD (International Automotive Design – an engineering company based in England) to make a running prototype of the MANA proposal, with design and modelling staff from America on hand to supervise the styling, while IAD did the chassis work based around the first generation RX-7; motive power and the drivetrain came from a rear-wheel drive Familia (323).

The prototype, featuring red paintwork and a black soft-top, was finished in September 1985 and duly shipped to America. The MANA staff decided to test the vehicle in Santa Barbara, being careful not to reveal the car's identity. The reaction was encouraging, with lots of questions and admiring looks during

the day. It was a good omen, and a perfect foundation on which to create two more clay models that pointed the way towards the final design.



The moving prototype that ran at Santa Barbara

Mass-Production Development

With Kenichi Yamamoto declaring "this car has an aura of culture," Toshihiko Hirai was appointed the Project Program Manager in February 1986, tasked with bridging the huge gap between ideas seen in a prototype and the harsh realities involved in making them ready for mass-production. Volunteering for the job, Hirai was the perfect man for this difficult undertaking, being a passionate engineer able to take things from the draughtsboard all the way through to a completed vehicle, and even having some sales experience in the late-1970s. His involvement was a giant step forward in making the MX-5 a reality.

With the factory still working flat-out on other projects, Hirai managed to put together a team of engineers, although some were forced to work outside their specialist field due to staff shortages. But with everyone pulling in the same direction, working via a shared philosophy, and gathered in the same area (a fifth floor office above the design center garage, later nicknamed the Riverside Hotel), progress was made, helped along by others joining the fray after their main work was finished, just to be part of this exciting project, meaning long hours for all involved.

There were no compromises. The Jinba-ittai philosophy developed by Hirai and his team called for a low overall weight with equal distribution over the front and rear axles, a low yaw moment of inertia, a low center of gravity, the engine placed as far back as possible, a PPF brace, a double-wishbone suspension, and an easy-to-use soft-top. These features would ultimately be carried through from one MX-5 generation to the next.

In the background, the styling team in Hiroshima built on the designs submitted by MANA in America, adding elements of traditional Japanese culture and beauty into the equation, taking the car ever closer to mass-production status.

A near-production prototype was sent to Los Angeles in the spring of 1987 to take part in a clinic to gauge reaction, and firm-up specifications and pricing. A total of 245 people attended, split into 30 groups, with the concept and design gaining high marks. US distributors also offered an encouraging voice, most requesting the vehicle be made available immediately. It was enough to silence the last remaining doubters in head office, and indeed, enabled the proposed production date to be pushed forward. To ensure this was possible, a 'design freeze' was declared in September 1987.

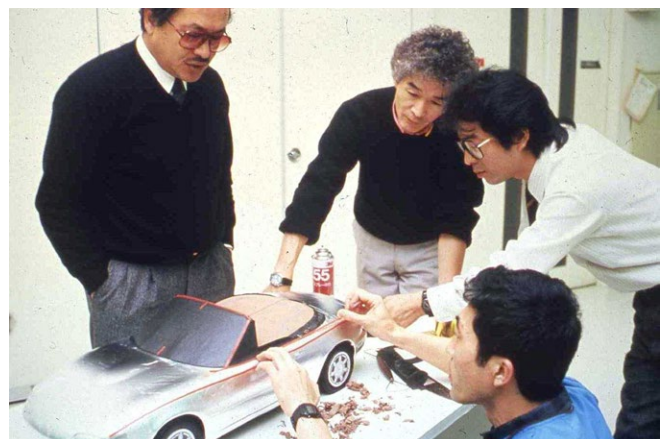

History Of Exterior Design

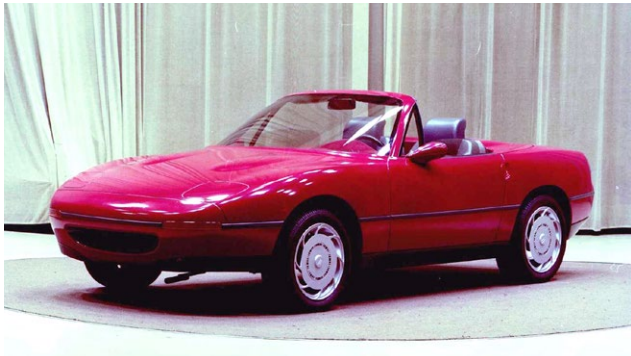

September 1984



December 1985



March 1986



July 1986

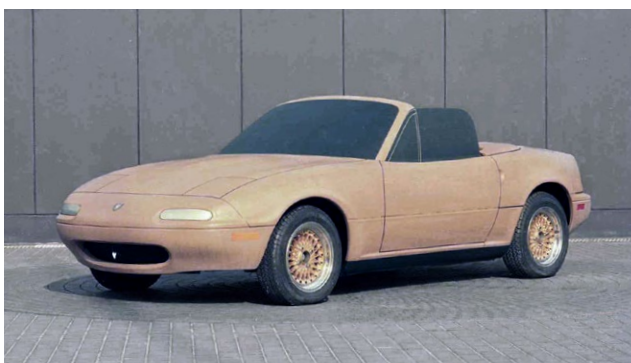

January 1987



July 1987



Launch Of A Legend

The world premiere of the MX-5 took place at the 1989 Chicago Auto Show. Five years had passed since the first seeds had been sown, with three of those years being mass-production development. The Mazda team had to overcome many hurdles during this time, but seeing the red, white and blue cars on display in Chicago made everything worthwhile. There was also a yellow Club Racer concept on the Mazda stand, but the extra effort was hardly necessary, for the press was ecstatic about the showroom model. There may have been



1989 Chicago Auto Show

a record chill outside the halls, but the arrival of the MX-5 guaranteed that the Mazda stand was busy every day.

After the Chicago Show, there was a strong request from the Japanese media for a speedy domestic launch, and to make test cars available. Mazda Roadster fever was gripping sportscar fans, too. Pre-orders were taken from the end of July 1989 for the home market, and there were chaotic scenes at all 46 places where bookings could be made.

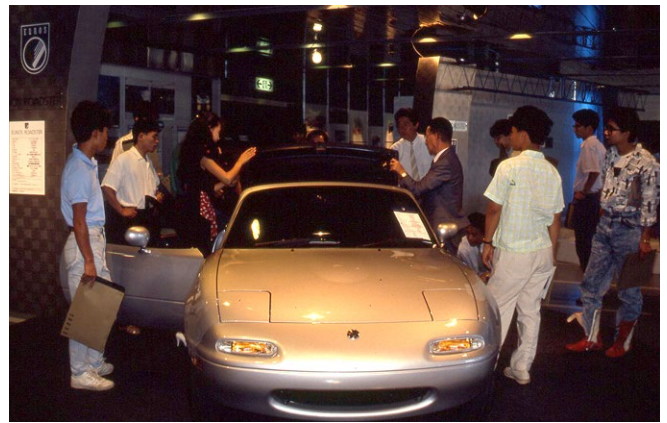

The first Roadster reservation meeting in Japan

Message To Commemorate 30 Years Of The MX-5



Bob Hall

Ex-motoring journalist who suggested the lightweight sportscar project, and duly joined MANA (now MRA) in 1981 on the recommendation of Kenichi Yamamoto

First and most importantly, it's been a great honor to be involved in the LWS project. Some folks have called me the 'Father of the MX-5', but I cannot possibly take that much credit. I had an idea, but if it were not for the vision of Yamamoto-san and the faith he had in the concept, it would have remained an idea and little more. The only person who's deserving of the 'Father of the MX-5' title is Kenichi Yamamoto.

But the people who were – and continue to be – the most instrumental in the fact that the MX-5 has been through four generations, with more than a million sold worldwide, are the buyers who recognize that driving should be fun. To them – past, present and future – I wish to say a big thank you! They are fortunate to be able to experience this unique car.



Tom Matano

Car designer, who joined MRA in 1983 following Bob Hall's recommendation. Responsible for the MX-5 concept

Looking back, the idea was to create a car you could love – the kind of car you'd drive just for the sake of it. You'd use it to get to work, then take the long way home to enjoy the scenery and the light dancing off it, and give a glance over your shoulder after putting it in the garage at night. Of course, times change, and family commitments might mean the need for a bigger vehicle. But the shared memories will be strong, prompting a return to the model in later years, perhaps even restoring one. I couldn't imagine what the MX-5 would be like in 30 years, but Mazda has stayed true to the concept of building a car you can love. I'm so happy to have been able to be involved with the LWS project from its earliest days...



The first-generation MX-5 (1989) and the movable prototype (1985) used for the "Santa Barbara Adventure"



FIRST GENERATION



The original MX-5 was inspired by the lightweight sports car (LWS) models that were incredibly fashionable in Europe and America in the post-war years through to the 1960s. Only a threat to outlaw open cars balked their popularity. However, this attractive concept would be revived using the very latest technology, adding modern reliability into the equation. It would be a new generation car for a new generation.

The Concept

Lightweight sportscars were primarily designed to be fun to drive, with their nimble handling and unbeatable feedback giving the driver a feeling of what Mazda calls Jinba-ittai – a term that roughly translates into a oneness between horse and rider.

The majority of traditional LWS models employed a front engine, rear-wheel drive (FR) layout, and a two-seat convertible body. Mazda would take this package from a bygone age, adding elements that would allow the new car to hold its own heading into the 21st century. To achieve Jinba-ittai, a number of key targets were formulated:

- All components must gel in a way that provides the ultimate form of communication between the vehicle and its driver, whilst also allowing a sensation of unity with nature.
- The creation of a cockpit that appeals to the five senses, focusing the driver in order to extract the car's maximum potential.
- Driver enjoyment must be put first, ahead of high-performance.
- The car must be endowed with quick and direct responses for perfect control.

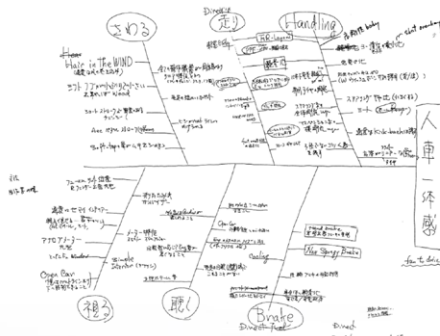

Fishbone chart
(in the early stages of development, the phrase "Jinsha Ittai Kan"
(feeling of unity between car and driver) was used)

In order to obtain the desired Jinba-ittai feeling, a fishbone chart was created as a checklist. The backbone was connected to six main headings – styling, handling, braking, driving enjoyment, tactile sensations, and sound – which in turn were connected to a series of pointers and specific components that helped please the senses within a given category. Constant reference to this now-legendary chart would ensure perfect harmony between the car and its driver.

However, this chart was not only there to help create an exciting sportscar, it would also ensure the owner would remain happy with it many years into his or her ownership. This noble goal was

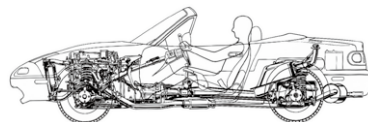

Overhead view layout drawing

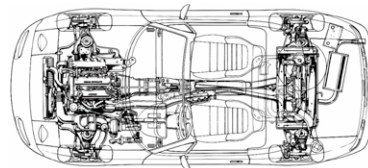

Side layout drawing

actually a stated theme during development, and needless to say, the Jinba-ittai concept has been carried over for each of the four generations of Mazda roadsters.

1st-Generation MX-5



Packaging

In order to realize the targets set out during development, the Mazda MX-5 was remarkably compact. With a wheelbase of 2,265mm, it had an overall length of 3,970mm, a width of 1,675mm, and a height of just 1,235mm. These dimensions ensured that a low body weight could be achieved, generally enhancing the car's overall performance characteristics. It was in the packaging, though, where the concept was honed, with the final product displaying 50:50 weight distribution, a low yaw moment of inertia, and a low center of gravity – essential ingredients in sportscar design.

To improve weight distribution, the traditional FR layout was refined by moving the engine back over the front axle as far as possible, almost to the point of the car having a front midship configuration. Other heavy components, such as the fuel tank, were also moved within the wheelbase, all with the goal of balancing the vehicle's weight equally over the front and rear axles and lowering the vehicle's yaw moment of inertia in mind. Further thought can be seen in the aluminium bonnet (which reduced overall weight as well as lowering the center of gravity), and the lightweight battery being situated in the trunk to counter the engine's bulk. At the same time, enough luggage space was provided for a short trip for two.

Other important factors in enhancing the 'Jinba Ittai' experience included the adoption of a double-wishbone suspension on all four wheels, and a special item called the Power Plant Frame (or PPF). The PPF was an aluminium structure that braced the tail of the gearbox and the nose of the differential casing, vastly improving response to throttle action.

The trademark packaging seen in the original MX-5 is a reflection of Mazda's philosophy for all the roadsters that followed...

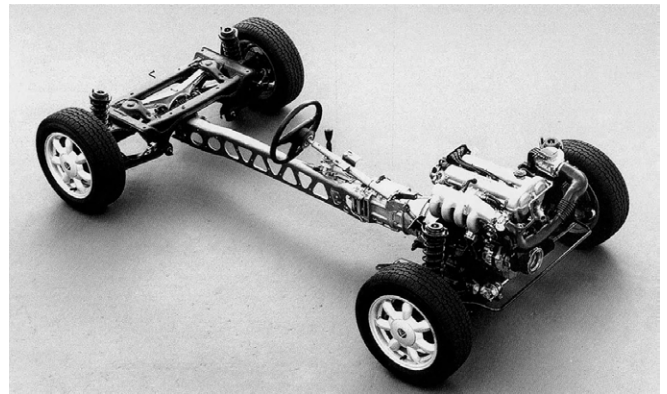

Bare chassis

Exterior And Interior Design

Not surprisingly, the exterior styling philosophy first and foremost called for lines that would hold an exceptional level of appeal. This is easier said than done, but using continuous curves, the designers drew on the subtleties of Japanese beauty, using light and shadow to play on the panels and create movement in much the same way as a traditional Noh mask would when worn by an actor. These vibrant reflections – later coined 'Echo and Sparkle' – can still be seen in Mazda's cars to this day, although Soul of Motion is the current term used at the company.

The open car configuration led to a huge amount of research on windscreen angles, mirror shapes and sizes, and so on, in order to control buffeting in the cockpit. A signature feature of the first generation MX-5 was the pop-up headlights, which were a Mazda sportscar hallmark, while the rear lights were styled to give the roadster a distinctive identity at the other end. Initially, colours were restricted to Classic Red, Mariner Blue and Crystal White, with Japan adding a Silver Stone Metallic shade to the palette.

Japanese culture was called upon once more for the interior, with a traditional tearoom providing the inspiration; this translated into a tight space with simple, minimalistic furnishings, and a feeling of anticipation. In typical LWS fashion, a T-shaped dashboard was employed, complete with large diameter, easy-to-read gauges, while high-back seats were specified to hold the passengers firmly in place.



Rear view



Interior

Chassis Development

The suspension was designed from a clean sheet of paper. As such, in a first for Mazda, a double-wishbone suspension was selected for both the front and rear, giving engineers and users alike a greater degree of freedom in setting the car up. It also had the advantage of keeping the tires in better contact with the road, giving consistent handling.

In line with Jinba-ittai goals, analysis and testing methods were changed in order to reduce mass to a minimum whilst retaining strength, and, as a result, Mazda was able to bring the weight of the double-wishbone suspension down to that of a comparable strut suspension. Costs were also kept in check by clever design work, such as common dies for suspension arms and crossmember components.

Steering was via a rack-and-pinion system, with the rack diameter increased to enhance direct feel through the wheel. A manual (non-assisted) and power-assisted steering set-up was offered, with the former giving a fast 3.3 turns lock-to-lock, while the power-assisted (PAS) option reduced this figure to just 2.8 turns lock-to-lock.

Ventilated disc brakes were specified up front, with solid discs used for the rear. In a bid to reduce the yaw moment of inertia,

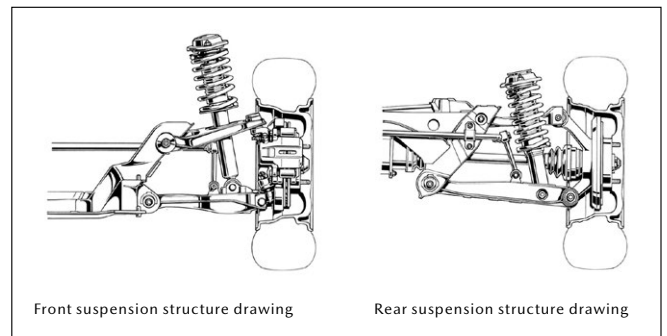

callipers were placed on the trailing edge of the front discs and the leading edge of the rear ones.

The 185/60 R14 tires were mounted on 5.5J wheels, which were supplied as either plain steel rims or seven-spoke alloys (seven spokes were chosen for their dynamic looks, and to reduce weight compared to the traditional eight spokes). The tires were designed especially for the Mazda roadster, the tread pattern offering enjoyable handling, while a 10% weight saving was a useful bonus.

The Power Plant Frame (PPF)

Made from lightweight forged aluminium alloy, with strategically-placed cut-outs to retain strength but keep weight to a minimum, the Power Plant Frame was designed to deliver a more direct level of feel for the driver by reducing the time-lag created via the movement of components in the driveline. With an FR layout, the nose of the differential casing constantly tips up or down a small amount in tune with acceleration and braking, but the PPF eliminates this

movement, giving a noticeable improvement in throttle response and refinement. An additional benefit was the reduction in mounts and strengthening pieces required, meaning a further trimming of body weight.

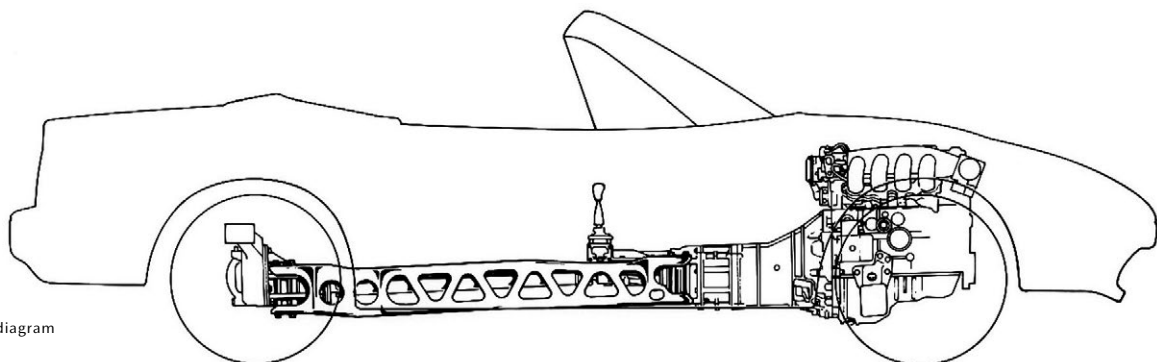

PPF structure diagram

The Powertrain

The powertrain was naturally developed to provide stimulating performance, but providing the owner with an attractive engine bay was also part of the MX-5 concept.

The starting point was the transverse-mounted engine from the second generation FF 323/Familia, which was converted to sit in an inline position with rear-wheel drive. In its new guise, with a cast-iron block and a pentroof aluminium alloy head with a central plug and revised valvetrain mechanism, the 16v four-cylinder 1.6-liter DOHC unit was given the B6-ZE (RS) moniker.

The B6-ZE (RS) had a 78.0mm bore and an 83.6mm stroke to give a displacement of 1597cc. With a 9.4:1 compression ratio and an electronically controlled fuel-injection system, it developed 120ps at 6,500rpm, along with 14.0kg-m of torque at 5,500rpm. In line with development goals, the unit's red-line was increased to 7,200rpm (as opposed to 7,000rpm for the 323/Familia engine) thanks to a fully-balanced crankshaft and lightweight con-rods, while response was dramatically improved throughout the rev-range.

An aluminium alloy oil sump and radiator were employed to save weight, along with a stainless steel exhaust manifold instead of a traditional cast-iron one. Mechanical noise was reduced to a minimum, but the exhaust sound was given special attention, emphasizing the car's sporting nature.

The engine compartment's appearance was enhanced through the use of a cast aluminium camshaft cover that accentuated the car's high-performance twin-cam set-up. Other than the

embossed lettering, it was deliberately left with a plain finish to give a pleasing look of functional beauty. Doubtless, enthusiasts will have spent many happy hours polishing it over the years!

Regarding the close-ratio five-speed manual transmission, engineers concentrated on making the shift quality positive combined with a light action. This was achieved by employing short strokes for gear selection, a low inertia clutch disc, and large diameter synchronizing cones. At the time, the 45mm 'flick of the wrist' stroke was the shortest domestic mass-production manufacturing techniques would allow. For the ultimate in sports driving pleasure, the MX-5 was offered with a viscous limited-slip differential as an option.



B6-ZE [RS] engine

A Combination Of Lightness & Rigidity

One of the major problems with an open body is retaining the shell's rigidity, especially with cars that have been converted from coupes, unless one adds a lot of strengthening pieces, leading to additional weight. However, the steel monocoque body of the MX-5 was designed as a convertible from the very beginning of development, and with the help of the most up-to-date computers available. As such, through careful design (the central tunnel and continuous lattice structure employed for the body were crucial elements in securing top class rigidity, as well as the A-posts and sills), it was exceptionally strong, but tipped the scales well within targets.

To improve handling, all overhanging parts were made as light as possible, with the bumper beams being an excellent example, made from resin using the latest blow molding techniques.

Regarding the soft-top, good use was made of the experience gained with the RX-7 Cabriolet and domestic market Familia Cabriolet, as well as valuable input from the respected English engineering consultants, the International Automotive Design

company (IAD). The end result was a practical and well-trusted convertible top that was easy to operate, with a lightweight zip-in vinyl rear window offering greater ventilation options for the driver. For those who wanted the utmost comfort for winter weather, an attractive detachable hardtop made from sheet molding compound (SMC) was made available as an option. For North American market, driver's side SRS airbag was a standard equipment for MX-5 and it was the first fitment for Mazda cars ever sold in the global market.



Detachable hard top

Production Changes To Match The Era

The MX-5 was forced to undergo a number of changes to meet regulations and so on, but with each upgrade, the original concept was kept without question.

In 1990, a four-speed automatic transmission was offered as an option, and in the same year, the V Special grade with green paintwork and a tan leather interior was added to the line-up.

1992 saw BBS wheels and Bilstein dampers introduced for the S Special, while the following year brought with it airbags and side-impact bars for added safety, along with a 1.8-liter BP-ZE (RS) engine that delivered 130ps at 6,500rpm and 16.0kg-m of torque at 4,500rpm. At the same time, the final-drive ratio was revised to 4.100:1, rigidity increased, and the suspension improved, all without any loss of the Jinba-ittai feel that had made the car so popular.

In 1995, the final-drive ratio was changed again, this time to 4.300:1, and while low-speed running quality was enhanced, the adoption of a new ECU and a lightweight flywheel helped top-end performance as well.



Vintage-oriented V special



More sports-oriented S special



A Car Loved The World Over

The MX-5 was officially launched at the Chicago Auto Show of February 1989. It made a huge impact everywhere it was displayed, with the press and public alike.

A few months later, in July, reservations started being taken for the Eunos Roadster (the early cars were given the Eunos Roadster moniker in Japan, by the way, the Eunos element coming from the name of Mazda's domestic sales channel that handled the two-seater and several other models at that time), with long queues forming by those eager to buy one.

The original MX-5 was listed between 1989 and 1997, with around 450,000 units sold, proving the adoration people attached to this small, fun-to-drive sports car in all corners of the globe.

The first generation model, by putting the driver first, revived the LWS market and duly became the benchmark for other manufacturers. Since then, three more generations have followed, but, in each case, Mazda has never wavered from the goals set out for the original car. The desire to create the ultimate lightweight sports car lives on...



Toshihiko Hirai

1st Generation MX-5
Program Manager

When I first became the original MX-5 program manager, the project had been rubber-stamped, but the budget was limited, as were the number of staff available. In addition, as a breed, the lightweight sports car was becoming a real rarity, and I couldn't help wondering if we could ever bring back the small convertible under such conditions. But as a band of enthusiasts giving maximum effort, the car was ultimately realized, and then so well-received that it was allowed to evolve following the exact same concept we'd laid out all those years ago. Few would understand how difficult it is to create such a vehicle in the face of unfavorable regulations and circumstances, especially those confronting engineers today, but I hope Mazda can continue its noble pursuit of providing fun-to-drive cars far into the foreseeable future.

Note: The above picture and comments are as of 2014.

SECOND GENERATION



The original MX-5 garnered many fans from all over the world during its nine years of production. But things had moved on, both in terms of engineering and regulations, meaning it was time for Mazda to overhaul the roadster concept in order to keep it up-to-date and uphold the company's policy of endowing its sportscars with the very latest technology available. In addition, customer interest had grown in areas like safety and comfort, leaving the creation of a brand new model as the only way forward. The new car was duly released in January 1998...

New Body, Same Soul

While there was little choice in adopting a new body for the second generation MX-5, Mazda's engineers were determined to leave the roadster's attractive Jinba-ittai spirit intact. Indeed, one of the key objectives was to build on the original concept in such a way as to make the new car appeal to an even wider audience. While the first generation model was undoubtedly a 'Fun' car, as was intended from the start, its replacement would be developed using the phrase 'Lots of Fun'.

The Second Generation Car's Concept

With the 'Lots of Fun' image established as a firm starting point, Mazda's engineers broke down the concept into three main categories in order to create a set of goals that would guide the program team through the car's development:

- The 'Fun of Styling' heading included a desire to produce a vehicle that was instantly recognizable as a Mazda roadster. It would be dynamic, yet possess a timeless simplicity that would allow it to age gracefully.
- The 'Fun of Sports Driving' dictated that the car's controls and response would be like an extension of the driver's mind and body.
- The 'Fun of Open Air Motoring' would aim to enhance the roadster's sophistication in open mode to increase enjoyment in all four seasons.

Inherited Packaging

Development of the first generation MX-5 highlighted that packaging was the most important factor in establishing the feeling of Jinba-ittai. A compact body size combined with a comfortably tight interior space was a feature that was carried over, along with an FR layout, a double-wishbone suspension set-up on all four wheels, and, of course, a Power Plant Frame. The second generation car was almost the same size as the original. With a wheelbase of 2,265mm, it measured 3,955mm in length, 1,680mm in width, and had an overall height of 1,235mm. As before, weight distribution was a level 50:50 front to rear, with weight-saving measures such as fixed headlights helping to keep bulk in check.

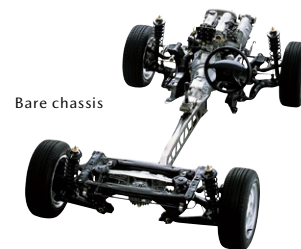

The new car sported improved aerodynamics and cooling, and on the practical side, better visibility thanks to the high-efficiency headlights and glass rear screen, plus a larger trunk area due to the battery and spare tire being moved to an underfloor position. This not only increased the luggage capacity – upped from 124L (VDA) to 144L – but also lowered the car's center of gravity at the same time.

2nd-Generation MX-5



Design Refinements

The stylists were given a difficult job of creating a balance – it was considered that the car should be an obvious evolution of the original, yet also look different enough to give the impression of a new model. The use of continuous curves was inherited from the first generation roadster, with a stronger line adopted for the top of the fenders and trailing edge of the bootlid to add a more dynamic character and express movement, even when the car was stationary. The frontal styling was dominated by the newly adopted fixed headlights and a reprofiled air intake – free of gimmicks, fresh, and somehow still familiar.



Interior



Rear view

Regarding the interior, the basic T-shape dashboard and concept of the first generation model were carried over, but the stylists amplified the sporting image, adding more sophistication and function into the package, in keeping with the times. A new three-spoke steering wheel with a compact airbag was employed, designed in conjunction with Nardi, and the gauges were given fresh calibrations (six-speed manual models were given meters that had the zero on the speedometer and tachometer at the six o'clock position, for instance) and revised coloring to further strengthen the car's sporting credentials. Practical advances included the adoption of cupholders, along with a larger glovebox and door pockets.

A Powertrain That Responds To The Driver's Will

The second generation roadster was offered with two inline four-cylinder powerplants – the 1.8-liter BP-ZE (RS) engine, and the 1.6-liter B6-ZE (RS) unit. Both DOHC units featured improved breathing, giving higher power and torque output, better response, and smoother running throughout the rev-range.

The 1.8-liter powerplant was given a variable intake control system, delivering greater efficiency by changing the intake port shape to best match engine speed, while a new 4-2-1 exhaust system was adopted, with the silencer size increased to improve gas flow and reduce back-pressure. With a bore and stroke of 83.0mm x 85.0mm, and a higher compression ratio (increased from 9.0:1 to 9.5:1), the unit produced 145ps at 6,500rpm, along with a maximum torque figure of 16.6kg-m at 5,000rpm.

The 1.6-liter engine also gained the variable intake system (VICS) and 4-2-1 exhaust configuration, improving response and fuel efficiency, as well as top-end torque. In this latest guise, the unit gave 125ps at 6,500rpm and 14.5kg-m of torque at 5,000rpm, delivering useable power throughout the rev-range for added driver enjoyment.

The 1.8-liter engine was mated to a newly-developed six-speed manual transmission (6MT), while the five-speed gearbox (5MT) used on the 1.6-liter model was given further refinements. With the short 'flick-of-the-wrist' shift of the original MX-5 still very much in evidence, the new 6MT unit,

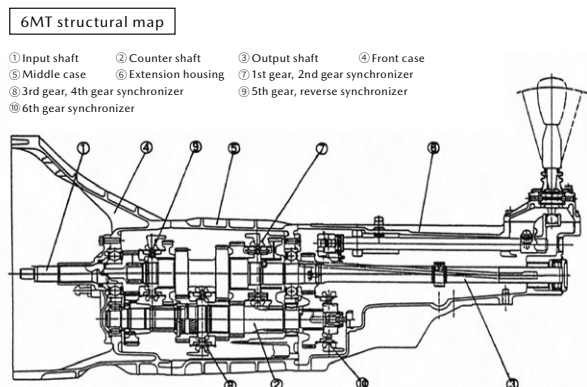

with only the top gear overdriven, allowed the driver to enjoy the sporting nature of the engine to the full. A limited-slip differential came as standard on domestic 6MT and certain 5MT grades, and was available as either an option or part of a package for manual cars in most countries.

At the same time, the four-speed automatic transmission (4AT) was enhanced with electronic control improving shift quality and giving faster response in the gear hold mode, making the automatic option a lot more sporting compared to earlier versions.

Chassis

The double-wishbone suspension that had become such an essential Jinba-ittai ingredient for the first generation model was carried over, albeit in a more matured form. For instance, the track width was wider at both ends, spring and damper units gained different mounts, the geometry was revised and optimized up front, and the suspension stroke increased at the rear. These changes enhanced the car's high-speed stability, and helped generate more linear handling characteristics. At the same time, the steering mounting system was made stronger to further improve road feel and feedback, while the four-wheel disc braking system was much the same, with ABS available on certain grades.

To Feel The Breeze

The soft-top was refined via the adoption of a glass rear screen, giving better weatherproofing, a reduction in wind noise, and the benefit of a heated rear window – a useful addition for those using the car all year round. Other parts within the soft-top assembly were revised in order to compensate for the extra weight of the glass window, to the point where the finished article was actually lighter than the original version! Another bonus was that it was no longer necessary to unzip the rear window before dropping the hood.

With experience gained from the RX-7 Cabriolet, a new 'windblocker' panel behind the seats made winter driving a lot more comfortable by reducing cockpit buffeting and cutting out drafts that tended to swirl around occupant's legs with the car in motion.

A great deal of effort was made updating the audio components, with Mazda and BOSE working together to create a high-quality yet lightweight system that would perform perfectly even in a demanding open car environment. Ultimately, a compact 200W amplifier was linked to a pair of eight-inch woofers and another pair of smaller tweeters, with the head end incorporating a CD player and radio. This BOSE system was standard on some cars, optional on others.

A Body With Greater Rigidity And Safety

The rigidity of the body was increased in order to extract the maximum benefit from the suspension system and enhance ride comfort. This was achieved by careful computer analysis of the shell, revealing any potential weakness points, and allowing engineers to add strengthening pieces in strategic areas to cope with the performance of the latest powertrains. Equally, the computer programs helped pinpoint places where weight reduction was possible, either via thinner panels or the complete deletion of unnecessary parts.

Front and rear crumple zones were incorporated into the design, so that even the most stringent of regulations and crash tests could be passed with ease. Repair costs from lighter accidents were reduced thanks to easier bolt-on parts replacement, although the exotic aluminium bonnet was still considered a must for keeping weight down to a minimum.

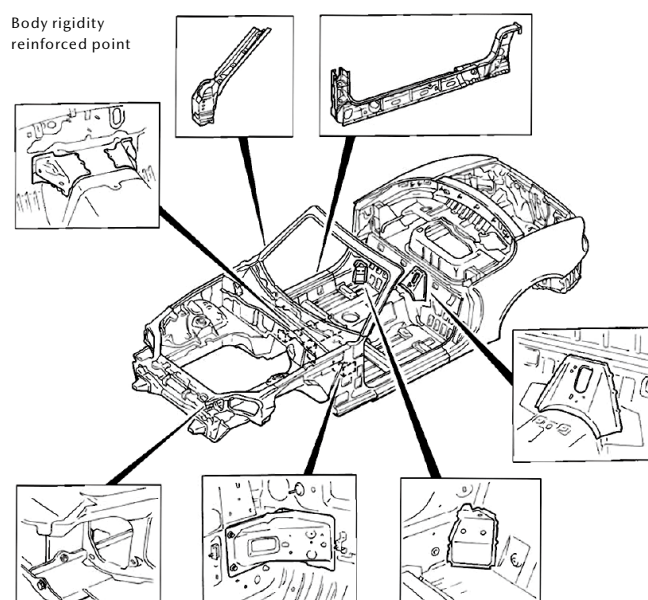

Continuous Improvement

The second generation MX-5 was given a major facelift in the year 2000, with a new front bumper molding and fresh headlight design endowing the car with a sharper image that exuded quality. The 1.8-liter engine gained the S-VT variable valve timing system to deliver a higher power output and better response throughout the rev-range. At the same time, the body was strengthened to further increase rigidity, allowing improved handling and smoother progress. For those after the ultimate in road behavior, the RS and RS-II models came with 16-inch wheels, along with an updated suspension and braking system.



The 1800 RS-II grade added as a model renewal



"NR-A" (outfitted with dealer options)

Late 2001 saw the launch of the NR-A grade, which allowed enthusiasts to enjoy grassroots motorsports at reasonable cost. This 1.6-liter twin-cam model had an adjustable Bilstein suspension, stronger brakes and a larger capacity cooling system to make it ideal for casual track work at the weekends, but it was equally suited to regular road use as well.

The second generation MX-5's 'Lots of Fun' development theme moved the convertible concept forward in many ways – enhanced power and handling, a body design full of character and superior packaging, and improved safety and comfort for the driver and passenger. The fun element was later boosted by the ability to custom-build a vehicle via the internet, and there was also a coupe version of the car made available to special order. In addition to numerous limited editions, a turbocharged model was also added to the line-up in due course, giving people an almost limitless number of ways in which to enjoy the MX-5 until the new third generation roadster was released in 2005.

By the time the second generation run had come to an end, almost 290,000 had been sold, gaining a new set of fans to augment those already smitten by the MX-5 concept – a concept that had kept Mazda's little sports car firmly in the number one spot in the Guinness Book of Records as the world's best-selling two-seater convertible. The second generation roadster would provide an excellent foundation on which to build, providing a clear direction for the next generation to follow...



**Takao
Kijima**

1st, 2nd &
3rd Generation MX-5
Program Manager

I took over the role of MX-5 program manager following the retirement of Hirai-san. I'd seen first-hand how difficult it was to create such a lightweight machine from the very start of the roadster project, but the high wall facing us in following such a detailed concept theme to the letter only served to forge the car into something special.

When planning the second generation car, it was obvious that the original had managed to keep its charm intact, leading us to change only what was absolutely necessary. In the background, though, company policy back then stated that a new model had to be capable of sales amounting to 70% of those posted by its predecessor in order to keep a line going. Seeing as the original MX-5 had sold so well, as you can imagine, we were under enormous pressure. I can remember with a great deal of pride the day when we cleared our sales target to make the next generation possible, with the car's popularity in Europe helping to boost the figures.

We'd learned so much during the development of the second generation model that we were able to apply many new ideas to the third, whilst still maintaining the original concepts and distinctive MX-5 character.

THIRD GENERATION



The third generation model continued the traditions established with the earlier roadsters, but signalled a huge jump in the technology stakes, bringing about higher levels of performance and even greater unity between the car and its driver. Whilst keeping the Jinba-ittai concept firmly in mind, with engineers able to start from a clean sheet of paper, almost every part was renewed in order to capture the roadster's charm but still take it forward into a new era. Going on sale in August 2005, in the following year, a power retractable hardtop model was added to the line-up, allowing the two-seater Mazda to appeal to a wider market and garner even more fans.

A Shared Concept

The second generation roadster was based on the platform of the original MX-5, but for this new incarnation of Mazda's iconic sports car, almost every component was redesigned in a bid to concentrate the Jinba-ittai spirit, ultimately combining to make a car that was yet more focused on driver enjoyment.

Development of the third generation roadster started in March 2002, but with a team of almost 100 people that was largely new and young. This meant a crash course to share the concept and deep meaning of Jinba-ittai – a philosophy that needed to be fully understood before work could commence. Once the educational period was over, each member made a declaration on how they could enhance Jinba-ittai in their specialist field, with the words put together and made into a book, which was then copied and distributed throughout the team as a form of constant reference.

Many test sessions were conducted with older Mazda roadsters and competing machines from rival companies, helping members of the team to gain a clear vision of the development theme and duly refine the fishbone chart that was made famous during the genesis of the first generation car. The three basic elements were driving, cornering and braking, with styling, sound and touch added to please all the senses. In reality, the general look of the chart was not all that different to the original, although the details contained within each element were duly updated.

Ultimately, fun was the very essence of the concept. Unity between the car and its driver was of paramount importance, but equal effort was put into making the vehicle attractive to look at, as well as easy to convert into an open car. Not surprisingly, the 'Lots of Fun' theme was carried over from the previous model.

Design Image

The starting point for designers was to analyse what had made the first two generations so popular. The consensus was the low body height, the flowing shoulder line and the car's excellent proportions. These fundamental elements would be taken and allowed to evolve in a thoroughly modern fashion under four headings: Simple, contemporary, fun, and friendly. As with its predecessors, bold character lines were pushed aside, with surface reflections used to give the roadster a subtly different image when viewed from different angles, as well as accentuate the vehicle's athletic volume and a latent sporting prowess to give a dynamic form.



Exterior design



Interior design

For the interior, the concept was to create a perfect balance between the sense of comfortable tightness and airiness within the cockpit. The basic themes found in the earlier cars were carried over, but modernized in a bid to add more emotion and sporting content into the equation. Sharper lines were used to highlight the T-shaped dashboard and center console, enhancing the feeling of strength and quality.

3rd-Generation MX-5



A Change In Body Size

The specification called for a reduction in the yaw moment of inertia, an even lower center of gravity, and the engine and fuel tank as close to being within the wheelbase as possible. At the same time, cockpit space had to be increased for taller drivers, so the wheelbase was extended by 65mm to 2,330mm. Careful design resulted in an increase of just 40mm in overall length, taking the total to 3,995mm, while the width increased by a similar amount. This was the absolute minimum engineers could allow due to the addition of side airbags.

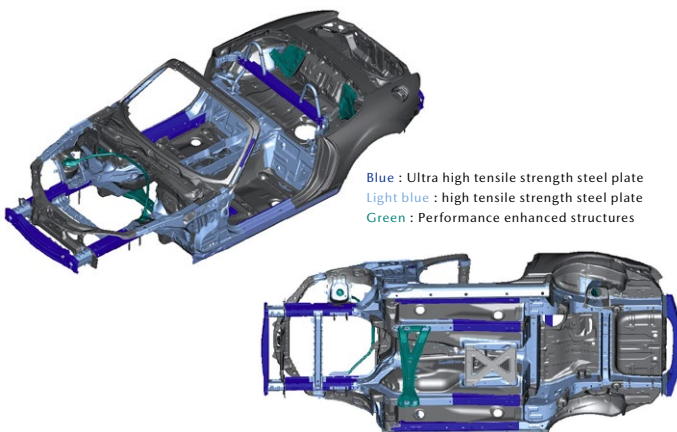

Safety body with 4 airbag systems

Naturally, compact dimensions were a must for the MX-5, but so was low weight. The latest CAE technology was employed to keep the third generation body as light as possible, with the choice of metals (such as the use of super-high tensile steel) crucial in retaining the shell's rigidity for the minimum weight penalty. Compared to the second generation body, bending rigidity was improved by 22%, and torsional rigidity by a massive 47%; at the same time, the body-in-white was 1.6kg lighter.

Like the earlier cars, the new MX-5 used an aluminum bonnet (or hood) and an alloy PPF brace, but further weight reductions were gained through an aluminum bootlid outer panel that used groundbreaking friction welding technology to secure the sheet metal to its steel reinforcement, alloy front suspension control arms and rear hub supports, alloy brake callipers, and the adoption of alloys for numerous other smaller parts. Plastics were employed for items like the engine head cover and intake manifold, while high-tensile steel was used for the seat frames, and the front stabilizer bar was made from hollow tubing to save a few more grams.

On the subject of grams, a 'Gram Strategy' team was given the job of eliminating bulk wherever possible, even if the resulting loss was as low as a single gram. This was done through 3D modelling and extensive testing, ultimately leading to things like flanges being shaved and fasteners shortened to keep weight under control. As a result of these efforts, despite a greater level of safety and creature comforts compared to the second generation car, overall weight increased by just 10kg.

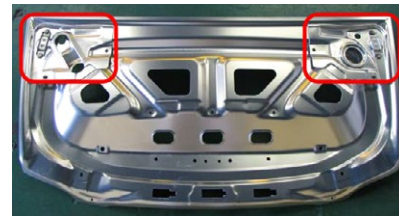

Achieving Perfect Balance

In order to obtain the ultimate handling control, a 50:50 front-to-rear weight distribution ratio is highly desirable, as is a low center of gravity and a low yaw moment of inertia. As established with the first and second generation cars, this can be achieved through the careful packaging of components. The engine was moved 135mm rearwards thanks to the air conditioning control unit being made smaller, and the battery was moved from the trunk to a new position ahead of the engine, allowing it to sit 265mm closer to the vehicle's center of gravity. At the same time, the underfloor fuel tank was moved further forward and lower than before. Compared to the second generation roadster, the third generation car sported a center of gravity that was 18mm lower, and a 2% reduction in the yaw moment of inertia.

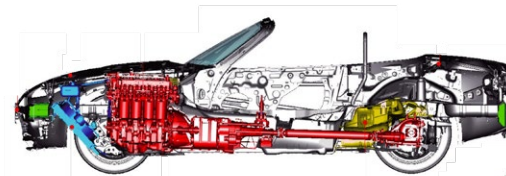

Optimized weight distribution front and rear

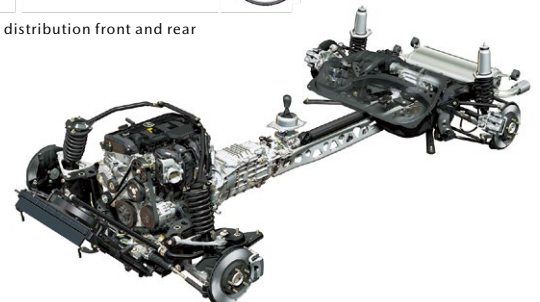

A Fresh Powertrain

The powertrain was revised in order to give even faster and more linear response, to further enhance driver enjoyment. The 2.0-liter inline four-cylinder LF-VE engine was chosen for the job as the main unit, converted from the FF-configuration MZR unit to match the open car's front midship rear-wheel drive layout. Adopting sequential valve timing (S-VT) on the intake side, a variable induction system (VIS) and a high compression ratio, it developed 125kW (170ps) at 6,700rpm (122kW (166ps) on automatic cars), and 189Nm (19.3kg-m) of torque. Moreover, applying the latest technology allowed around 90% of peak torque to become available from just 2,500rpm, with the torque remaining relatively flat thereafter.

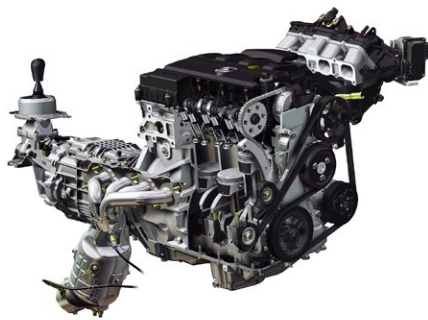

LF-VE engine + 6MT

The European market was supplied with a 1.8-liter version of the all-alloy unit giving 93kW (126ps) at 6,500rpm, along with 167Nm (17.0kg-m) of torque at 4,500rpm. Generally speaking, this was an optional 1,798cc engine for EU countries, available alongside the 1,999cc one.

The car was available with a newly-developed six-speed manual transmission (6MT), combining carefully chosen close ratios and short shift strokes to provide a sporting feel. A triple-cone synchromesh was provided on the lower four speeds to make changes even swifter and easier, while the shift linkage used low-friction bushes and a new guide plate to give a smooth and direct action. The 5MT gearbox was also improved.

The automatic transmission was completely revised, becoming a 6AT unit that allowed stronger acceleration, whilst at the same time improving fuel consumption and refinement at higher cruising speeds. In addition, shifts could be executed via the traditional-style gear selector on the transmission tunnel, or by paddles mounted on the steering wheel.

In keeping with the Jinba-ittai concept, the engine and transmission combined to give the ultimate in driver involvement and lively performance, the strong acceleration feel being backed up by comfortable sporting sounds from the engine, intake and exhaust systems.

The Suspension System

The suspension was designed to achieve the functions one expects from a LWS model, such as nimble and linear handling, allied to superior stability.

The front suspension consisted of a double-wishbone set-up carried over from the earlier roadster generations, but further refined to give sharper responses to driver input. Alloy control arms were used to reduce unsprung weight, while their length was calculated to keep the tires in maximum contact with the road, with linear control in toe, camber and caster angles according to tire stroke to enhance handling stability.

At the rear, a brand new multi-link suspension system was adopted, with five long links to give vastly improved stability. The rear suspension featured anti-lift and anti-dive geometry for smoother progress under acceleration and braking, while the braking system itself was upgraded via larger rotors, a bigger servo and a revised pedal stroke to give enhanced driver feedback.

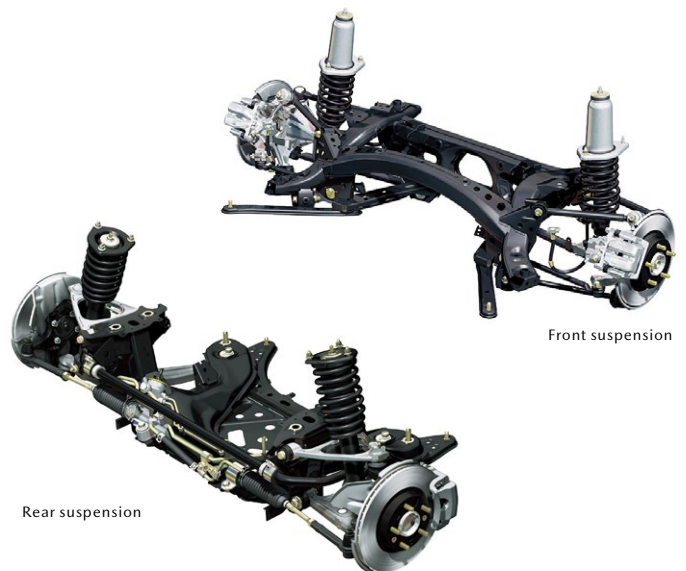

Front suspension

Rear suspension

Polishing The Gem

An expert team was put together to perfect the Jinba-ittai character of the car called a 'Unity Feel Taskforce'. These engineers were encouraged to provide visceral information on driving dynamics in addition to traditional technical data in order to achieve predetermined goals in each area of

development, such as performance feel, creating balanced handling, fine-tuning the vehicle body's response to driver input, response and feedback from controls (such as the steering, and accelerator, clutch and brake pedals), and the comfort and support provided by the seats.

Soft-Top Refinements

The soft-top was modified in order to bring the joy of driving convertibles to a wider audience. With a single central release handle, the top folded into a Z shape before dropping into its compartment behind the seats. At the same time, assistance springs helped reduce driver effort when closing the top, allowing them to remain comfortably seated whilst carrying out this operation.

To enhance comfort with the top down, the front quarter

windows were made smaller, and the windblocker became a mesh version. Combined, these allowed a controlled breeze into the cockpit compared to the older set-up with the board erect.

In addition, improvements to the air conditioning vent layout gave greater warmth around the waist area, duly lengthening the open car season, and a special BOSE sound system reacted to noise interference to maintain sound quality.

Power Retractable Hardtop

August 2006 witnessed the debut of the innovative Power Retractable Hardtop (RHT) model. The electrically-controlled roof came in three sections – a front piece, a central part surrounding the back window, and the window glass itself – folding to sit below a tonneau panel at the back of the seats.



The power retractable hard top model added in 2006

The deck panel covering the space occupied by the roof operated in tandem with the RHT, opening to accept the metal roof sections, and then closing again once they were stowed underneath.

The RHT was designed in such a way that it was stored completely within the cabin area, so as not to encroach on luggage space, whilst also retaining excellent weight distribution. All components were given the usual 'Gram Strategy' treatment, allowing a weight penalty of just 37kg and an additional 10mm in overall height.

The styling retained the attractive lines of the soft-top model, with the roof opening and closing in 12 seconds (what was then the world's fastest time for such a mechanism) at the touch of a switch. Practicality and a minimal weight gain combined to ensure the driver's enjoyment was untainted.

The Concept Matures

The first facelift came in 2008, with the car sporting a new front bumper section with a pentagon grille shape that was becoming a Mazda signature, along with a sharper headlight, indicator and foglight housing design. Heavier sill sections (or rocker panels) graced the sides, while new rear light units were adopted at the rear. These changes gave the car a stronger image, with the chrome grille surround on certain grades adding an extra touch of class into the equation.

In addition, engine tuning led to a wider spread of power on manual cars, with the red-line moving further up the rev-range, and the roll center height was lowered at the front of the car, giving the steering a more natural feel on initial turn-in.

A second facelift was executed in 2012, with chin spoilers added to each side of an enlarged front grille opening, and a revised foglight design. Throttle response was further improved through tuning of the engine's ECU, the servo was modified for enhanced braking modulation, and a pedestrian-friendly Active Bonnet was added to the specification sheet, popping up in the event of an impact.



2008 renewal model



2012 renewal model

Foundations For The Future

The need for a new platform was forced upon Mazda due to a shift in safety and environmental regulations. Modern design methods allowed the sharing of common architecture with the rotary-engined RX-8, which also had an FR layout.

One of the key elements in Mazda's sportscars was the front midship mounting of the power-unit, making it possible to achieve 50:50 weight distribution and for the MX-5 and RX-8 to use the same production facilities. However, the items that gave the roadster its dynamic character – the body, chassis, powertrain and electrical equipment – were all unique to the two-seater. The same was true for the RX-8, ensuring all development goals were met.

Later generations of Mazda cars would employ the same development theme, with the exquisite unity of performance feel and dynamic efficiency found in the roadster becoming the foundation for all future model development.

More than 230,000 units of third generation MX-5s were produced between 2005 and 2015, raising the bar in the technology stakes, and deepening Mazda's already-strong relationship with its customers. The 25th anniversary edition unveiled at the 2014 New York Auto Show was a fitting finale for the third generation roadster, displayed alongside the chassis of the model that would replace it.



**Nobuhiro
Yamamoto**

3rd & 4th Generation
MX-5
Program Manager

I have been involved with MX-5 development for 22 years, eight of which were as program manager of the third and fourth generation models. As such, I'd seen how difficult it was to meet crash regulations with the third generation MX-5, and a slight increase in body size was simply unavoidable at the time, so to offset this, a lot of effort was put into weight reduction and polishing the car's handling in order to retain that Jinba-ittai feeling. After I took over from Kijima-san, we were able to introduce a number of updates and variations that allowed the basic model to continue for a total of ten years.

Advances in technology within the company, some of it realized through the MX-5 project, brought about new architecture that we were able to employ for the fourth generation – moving forward whilst keeping long-established development policies associated with the roadster alive.

Today, as we celebrate 30 years of the MX-5, the car reminds me of Polaris – a star that never changes and always shines brightly...

FOURTH GENERATION



The fourth generation MX-5 followed the long-established concepts of Jinba-ittai and ‘Lots of Fun’ – keynotes that had ran consistently through the development earlier generations of Mazda’s iconic roadster. Moreover, being able to start with a clean sheet of paper, engineers and designers were in a position to recapture the very essence of the original model, and even build on it through the use of the latest Skyactiv technology.

Announced in 2015, this latest incarnation of the MX-5 was joined in the following year by a new RF model featuring a retractable hardtop, melding practicality with distinctive styling, and giving enthusiasts the option of a totally different kind of open-air motoring. Like the soft-top version, this fastback model exuded Mazda’s all-encompassing Soul of Motion (or Kodo) design language.

Appealing to the senses and sensations

The significance given to maximizing the Jinba-ittai and “Lots of Fun” experiences means that Mazda did much more than simply develop a compact sports car. Rather, the MX-5 was made to be looked at, to perform and respond faithfully to the driver’s will, to deliver a pleasing experience and to emphasize the owner’s character. Just having an MX-5 makes life more pleasant and more colorful. The product concept, “Joy of the moment, joy of life,” reflects Mazda’s hopes that the all-new MX-5 will become a presence in the lives of customers that continues to transcend its existence as a mere car. To convey that desire more purely, the development team devoted themselves to adopting Skyactiv technology and



Kodo design to evolve the MX-5, while at the same time working to evolve the essence of what appeals to the senses and sensations through which people enjoy cars.

4th-Generation MX-5

Design

Designers wanted the new MX-5 to have a low profile, with lean looks and short overhangs, helping to accentuate the car’s nimble character. The LED headlights, some of the smallest and lightest in the world, were a big factor in allowing the front-end to be as low and taut as it is, aided by the engine sitting lower and further back than before.

While rich Kodo-inspired styling was a must, the designers took an interesting stance in styling the new body, aiming to make the driver stand out with the top down in the hope of conveying the joy of driving to onlookers. For Mazda, a car has always been much more than just a tool. It is a life partner – an expression of the owner’s character, and something to interact with, both on a personal level and amongst friends.

Extending this philosophy, the designers decided to better integrate the interior and exterior. These two styling aspects were successfully bridged through the use of door cappings painted in body color. Giving the image of a continuous line down to the top of the front fender (raised to allow accurate positioning during cornering), they reflected the moving light and made the driver feel part of the machine – a feeling further enhanced by the purposeful cockpit, featuring a small steering wheel, a clear set of gauges, and minor controls that expressed simplicity and symmetry.



Weight Reduction

The image of Jinba-ittai calls for nimble and lively handling, with the driver feeling in full control. As had been established in previous generations of the roadster, one of the key factors in achieving this is by employing compact body dimensions with weight being reduced to an absolute minimum.

Thankfully, engineers were allowed to apply the latest Skyactiv technology on a brand new body structure, fusing it with know-how accumulated over decades of open car design. Whilst being an evolution of the third generation model in terms of basic layout (albeit with a larger cross-section in the backbone and the creation of more truss shapes for added rigidity), careful construction and the extensive use of lightweight materials, such as high-tensile steels and aluminium, meant that the body-in-white was ultimately around 20kg lighter than its predecessor. With all exterior panels except the doors and window frame being shaped from aluminum, this was the lightest MX-5 shell produced to date, yet also the stiffest and safest.

A new smaller and lighter six-speed manual transmission was adopted to save weight, as was a new differential with the same benefits in mind. Suspension revisions and lighter brake rotors saved 18kg, while the seats were completely redesigned, saving a massive 15kg for the pair. The new design also allowed them to sit lower in the vehicle to improve the position of the car's center of gravity.

Additional weight savings were gained via the 'Gram Strategy' program, with material choice being the first option en route to cutting unwanted bulk, and fine-tuning in other areas (such as drilling holes in components wherever possible to reduce weight without any loss in strength, and trimming any excess on glass, fasteners and welds).

Powertrain

Domestic models were powered by the all-new 1,496cc Skyactiv-G fuel-injected engine, developing 96kW (131ps) at 7,000rpm, with tuning that gave lively and accurate response and a smooth flow of torque from lower revs all the way through to its 150Nm (15.3kg-m) peak at 4,800rpm and beyond.

A great deal of work was carried out to reduce the weight of components, such as the intake system and the 4-2-1 exhaust manifold, and there was a huge improvement in fuel efficiency, resulting in a welcome reduction in exhaust emissions.

This naturally-aspirated 1.5-liter unit, was also available in Europe and other export markets as a base engine, lining up alongside a 1,998cc version, which gave 116kW (158ps) at 6,000rpm, along with 200Nm (20.4kg-m) of torque at 4,600rpm; both sported a very high 13.0:1 compression ratio. As with earlier generations, the exhaust sound was tuned to be sporting without being harsh, while an induction sound enhancer (ISE) delivered a pleasing note ahead of the cockpit.

Both four-cylinder engines were linked to a new six-speed manual transmission (6MT), with a six-speed automatic gearbox (6AT) as an option. The 6MT unit, with a direct 1.000:1

top gear ratio, was more compact than the one found in the third generation MX-5, with a shift connection that gave light but direct responses, along with the pleasing notchiness found in earlier MX-5s. Combined with a clutch designed to enhance pedal feedback and a revised version of the PPF brace, the driver could feel in complete control of the vehicle.



SKYACTIV-G 1.5 engine

The Laws Of Packaging

Every roadster generation has seen new technology adopted, but the rules of packaging in order to create superior sports car balance and handling have never changed.

At the front, the new MX-5 adopted a now-traditional double-wishbone suspension, matched with a light and rigid multi-link set-up at the rear. With the help of computer analysis, the suspension was developed to provide a natural feel under braking, controlling the car's shift in weight, and was optimized to provide a crisp turn-in and linear handling characteristics. The fourth generation was the first MX-5 to adopt electrical power-assisted steering, with the double-pinion rack (DP-EPAS) chosen delivering accurate and linear feedback through the steering, adding to the driver's confidence in the machine's reactions.



SKYACTIV CHASSIS

At 3,915mm, the overall length of the body is the shortest of all the MX-5s, while the engine sits 13mm lower and 15mm further back than it did in the previous models. The driver also sits 20mm lower and closer to the car's center, helping to reduce the vehicle's yaw moment of inertia and center of gravity, while the ergonomics were refined, improving visibility, making vehicle controls and switches easier to operate, and the pedals feel like a natural extension of the driver's body.



Appealing To The Senses

The car was designed to appeal to all five senses. The soft-top mechanism was revised to make it even easier to operate from a sitting position, having a light and smooth action, and once down, the windscreen frame, quarter windows and seals were positioned and shaped in such a way as to stop drafts whilst allowing a gentle breeze into the cockpit.

Despite the need to shed as much weight as possible, resulting a car that was around 100kg lighter than its predecessor in certain model grades, the new MX-5 was full of convenience

features. To give clear music with the top down, headrest speakers – an idea first seen on the first generation roadster – were put back on the spec sheet, at least as an option, coming as part of the dedicated BOSE sound system. The Mazda Connect[†] (or MZD Connect) system was also available, offering hands-free infotainment.

[†]1 The name Mazda Connect is used in Japan, US, Canada and Mexico. The system is referred to as MZD Connect in other markets.

A New Variant – The RF

The RF model offered an attractive fastback coupe silhouette in closed form, but at the touch of a single button, about 13 seconds later, it could be converted into something quite different. Making its debut in 2016, the RF model (with RF standing for Retractable Fastback) featured a new type of power retractable hardtop, but with the rear section containing the back window moving upwards to allow the center panels to be stowed away behind the seats. The rear section then dropped back into place, offering those in the car an open-top experience within a quieter and calmer environment. Like the RHT version of the third generation model, there was no

discernable increase in body dimensions, and no loss of luggage space. The RF was only available with the 2.0-liter engine, confirming its position as a flagship model.



Power retractable hard top model added in 2006

Evolution Of The Fourth Generation

After numerous awards from all over the world and passing the landmark of one-million MX-5s being built, the 2017 facelift made in time for the 2018 season witnessed the introduction of enhanced safety features, led by the i-Activsense package with adaptive LED headlights (ALH), several measures to further improve overall quality, and the availability of three new body colors, including the signature Soul Red Crystal Metallic.

In the following year, the RF's 2.0-liter engine was heavily

modified, gaining a fresh fuel-injection system, lightweight pistons and connecting rods, and revised ports and valves to give an improved spread of torque and better top-end performance. The red-line was pushed up to 7,500rpm, with maximum power now standing at 135kW (184ps) at 7,000rpm and 205Nm (20.9kg-m) of torque, lowered at 4,000rpm. At the same time, a telescopic steering column was added to the specification sheet – a first for the MX-5 – along with a number of driver safety aids.

Driving To The Future

The fourth generation car has been exceptionally well-received, following in the previous model's footsteps by winning the 2015-2016 Japan Car of the Year title, along with the 2016 World Car of the Year and World Car Design of the Year double, and numerous other awards worldwide. Not long after, in April 2016, we were able to celebrate the one-millionth MX-5 being built with fans from all over the world. The evolution of Mazda's roadster continues today, and will continue into the future...



Masashi Nakayama

Chief Designer
since 2011,
and now MX-5
Program Manager

As you can imagine, it was a big responsibility filling Nobuhiro Yamamoto's shoes for the LWS project, especially as my first job in the position of Chief Engineer. My initiation began with the production of a video presentation for the management in order to secure the future of the model against the backdrop of an increasingly difficult market for sportscars. It conveyed the spirit of the car, and the strong will of those behind its development through the decades – a passion that has enabled the MX-5 to remain loved by so many 30 years after its birth. The meeting concluded that it was our mission to keep such a car alive. It was a day I shall never forget.

PRODUCTION LINE



Every generation of MX-5, from the first to the fourth, has been produced at the Ujina factory (known internally as U1) in the Ujina area of Hiroshima. This plant opened as Mazda's main car factory in 1966, when Japanese motorization was at its zenith, and high demand combined with strong competition meant that greater manufacturing efficiency was a must. All processes – from pressings to painting and final assembly – could be accomplished as a streamlined operation, much of it controlled by computers, allowing a model mix on the line, which was unusual all those years ago.

In the past, the MX-5 has shared the line with cars like the Mazda2 (Demio), the 323 range (Familia), and the rotary-engined RX-7 and RX-8. Today, it can be seen in amongst the CX-3 and other models, adding interest for the many groups visiting the Mazda Museum, which includes a short tour of the U1 production line, linking our long history with the present. They can also see history in the making, as the Guinness Record for the world's highest production of a 'two-seater small open sports car' – first awarded in May 2000 – continues to rise with every day that an MX-5 rolls down the line.



During production, the car is followed by an automatic parts carrier that runs alongside it. All of the components necessary to build the vehicle to a unique specification are contained within it.

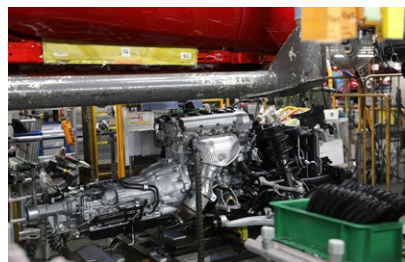

The domestic Skyactiv-G 1.5-liter engine being built. The engine is produced in a separate factory at the same time as the body, with the pair later mated on the line.



The building station for the PPF, a key feature of the MX-5. A special machine tightens the front and rear bolt sets at the same time to a preset torque value.



Computers automatically compensate for the variations in wheelbase measurements at turning points in the line, delivering the correct cage to suit the vehicle. This system allows different cars to share the same production line.



Putting the dashboard in place. Two skilled workers build up the dashboard to the required specification, adding meters and displays, and then mount it in the vehicle as a complete unit.



Naturally, the MX-5 RF shares the same line as the open model. Each car is built with the utmost care and attention to detail, from the very earliest stages of production all the way through to line-off.

PHOTO GALLERY

30th
ANNIVERSARY

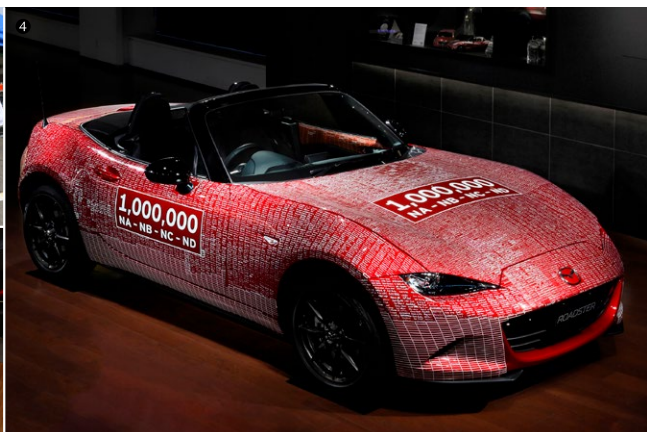

- ❶ In 2018, the first Roadster Santa Drive was carried out in Hiroshima
- ❷ MX-5 25th Anniversary parade, June 2014, Le Mans, France
- ❸ Mazda Jinba-ittai team participating in the Media Roadster 4 Hour Endurance Race
- ❹ 1 million units commemoration Roadster collected the signatures of 10,000 fans around the world
- ❺ The 4th-generation MX-5 running up the hill at the Goodwood Festival of Speed in 2015
- ❻ MNAO announces details of the GLOBAL MX-5 CUP at the SEMA show in 2014
- ❼ GLOBAL MX-5 CUP demonstration race held at Laguna Seca in 2016
- ❽ The 3rd-generation MX-5 shown off in Hawaii along with customers and fan representatives
- ❾ Bob Hall, who strongly suggested a LWS to Mazda, still owns a 1990 MX-5 Miata
- ❿ Roadsters Parade along Peace Boulevard at the Hiroshima Flower Festival in 2017
- ⓫ The 4th-generation Roadster is also active in the domestic Super Taikyu series
- ⓬ Miataland, a resort hotel located in the south of Perugia welcomes you with dozen of MX-5s collected by its owner
- ⓭ Shigenori Fukuda, former Head of Design at Mazda also cherishes his first-generation Roadster

Within the 30-year history of the Roadster (MX-5 Miata), there have been several unique limited editions and commemorative cars that reflect the era in which they were released. Among them were models that sported worldwide unified specifications, along with small volume production models. Also, in Europe, distributors from various countries released many of their own limited editions that incorporated their own original ideas.

1999



10th Anniversary Limited Edition MX-5

[7,500 units worldwide]

Based on the second generation 1.8-liter six-speed model with a tuned suspension from the RS Roadster, this model had a unique appearance, sporting features such as 'Innocent Blue Mica' paintwork and alloy wheels with a buffed finish. While predominantly black, the interior was given a two-tone look, with blue highlights to blend in with the exterior color. It also featured a BOSE sound system, chrome-plated rings on the outer periphery of the speedometer and tachometer, and a carbonfiber-style center console panel to give the cockpit an even sportier atmosphere.

2009



20th Anniversary Limited Edition MX-5

Based on the third generation model following its first facelift, this RS-based edition was available either with a manual soft-top and 6MT combination, or a retractable hardtop (RHT) matched with a 6AT gearbox. Made for the Japanese market only, it was equipped with exclusive red and black Recaro bucket seats, clear front foglamps, and a number of special 20th anniversary accessories.

2014



25th Anniversary Limited Edition MX-5

Based on the third generation roadster with a power retractable hardtop, this 6MT car had exterior styling that reflected the second facelift for the MX-5, and 'Soul Red Premium' metallic paintwork that would become a signature color for the company's 'next-generation' products. This was matched with black paint for the roof, front pillars and door mirrors, while the interior featured off-white leather seats and door trims, hand-finished interior decorative panels, and numerous other features.

2019



30th Anniversary Limited Edition MX-5

[3,000 units worldwide]

Based on the fourth-generation soft-top and RF models, this special edition featured exclusive Racing Orange paintwork and orange accents on the brake calipers, seats, door trim, dashboard, and shift lever. As a symbol of the company's gratitude toward the customers who have helped nurture the model over the past 30 years, features included a commemorative badge with serial number, forged aluminum wheels co-developed with Rays, Recaro seats, Bilstein dampers (MT models only) and Brembo and Nissin brake calipers in the front and rear respectively.

J Limited [800 units]

1991



This model featured a 'Sunburst Yellow' exterior paint color. Due to its high demand, the limited number of cars had to be allocated through a lottery.

S Limited [1,000 units]

1993



A luxury model based on the S Special, characterized by its red leather interior.

J Limited II [800 units]

1994



Based on the 1.8-liter Special Package model, it featured 'Sunburst Yellow' paint, and was equipped with bucket seats with separate headrests.

RS Limited [500 units]

1994



This car featured 15-inch BBS wheels, lightweight carbon-kevlar Recaro bucket seats, and Montego Blue Mica paintwork.

G Limited [1,500 units]

1994



The G Limited had a 'Satellite Blue Mica' body color combined with a navy blue top. It was fitted with Alcantara-trimmed bucket seats.

R Limited [1,000 units]

1995



This car was finished in blue or white with a red interior, and came equipped with 15-inch BBS wheels and a final-drive ratio of 4.300:1.

VR Limited

1996



Two variants were made: The A model had a wine red body and beige top, while the B model had green mica paintwork combined with a green soft-top.

B2 Limited

1996



The twilight blue mica body color also features a dark blue soft top, contrasted with buffed aluminum wheels and chrome-plated door mirrors.

R2 Limited

1996



Based on the S special, in addition to special 15-inch wheels and an aluminum shift knob, it combines red leather seats and white body color.

SR Limited [700 units]

1997



The SR Limited featured light green or white paintwork, two-tone leather and nubuck bucket seats, chrome alloy wheels, and a Torsen LSD on manual cars.

NR Limited [500 units]

2000



A six-speed manual model with wine red bodywork and a beige roof. It also featured unique gauges and a tan interior.

YS Limited [700 units]

2000



Available in three body colors, the interior was finished in black with a number of leather and titanium-toned trim parts.

Mazdaspeed Roadster [700 units]

2001



This model was equipped with a body kit, adjustable dampers, and a special Mazdaspeed exhaust manifold and sports muffler.

Roadster NR-A

2001



A 1.6-liter car aimed at motorsport enthusiasts, and equipped with an uprated braking and suspension system, along with Enkei alloy wheels.

MV Limited [300 units]

2001



An attractive 1.6-liter model combining a 'Titanium Gray' body color with a maroon leather interior.

SG Limited [400 units] **2002**



This car featured a 'Cerion Silver' exterior color, matched with a blue cloth interior and a blue soft-top.

Roadster Coupe **2003**
Type A [250 units]
Type E [150 units]



Planned and built by Mazda E&T, only a small number of these custom-made cars were produced. The Type A has an authentically designed race style. The Type E has a more calm and elegant design.

Roadster Turbo [300 units] **2004**



This six-speed manual model had an intercooled turbocharger, increasing the maximum power output to 172PS, and providing a 20% increase in torque along the way.

Third Generation Limited [3,500 units] **2005**



Finished in 'Velocity Red Mica' and featuring a number of exclusive chrome and aluminum parts, a total of 3,500 were built, with 500 reserved for Japan.

2006 Japan Car of the Year **2006**
Special Edition



Celebrating the MX-5's JCOTY award, this model combined 'Copper Red' paint with a red interior, or a 'Brilliant Black' exterior with a red interior.

Roadster NR-A **2006**



A base car for motorsports use, specially equipped with Bilstein dampers, a torque-sensing LSD, and so on.

Blaze Edition **2006**



This car adopted a special 'Radiant Ebony Mica' body color, BBS wheels, and a beige/black leather interior.

Mazdaspeed M'z Tune **2007**



Another Mazda E&T custom project, incorporating fine-tuning of the engine, a number of uprated parts, and so on.

Prestige Edition **2007**



An RHT-based car adopting luxurious components including black leather seats and BBS aluminum alloy wheels.

Black Tuned **2011**



An RHT-based model, with the a hardtop, door mirrors and alloy wheels finished in a special black tone.

Roadster NR-A **2015**



A base car for motorsports use, specially equipped with Bilstein dampers, a bigger radiator, larger diameter brakes, et cetera.

Limited Color Classic Red **2017**



Orders were accepted for this model with the same 'Classic Red' paint as the original roadster for a restricted period.

Red Top **2017**



This model combined a 'Dark Cherry' soft-top with an reddish-brown interior, with nappa leather used on the seats.

Caramel Top **2018**



This model adopted a brown-colored top and a new 'Sports Tan' interior color, featuring leather trim on the seats.

Main special edition cars released in the European and US markets

Le Mans [UK]

1991



A limited edition to commemorate Mazda's win in the Le Mans 24-hour Race. In addition to the distinctive paintwork, it was equipped with a 152PS turbocharged engine, an uprated suspension and OZ alloy wheels.

Monaco & Merlot [UK] 1996



The 1.6-liter Monaco sported 'British Racing Green' paint and a tan hood, while the 1.8-liter Merlot had a luxurious leather and wood interior to go with its wine red bodywork.

California [UK]

2000



This 1.6-liter model came with the popular 'Sunburst Yellow' paint and special aluminum alloy wheels as standard. Limited to 500 units.

Icon [UK]

2000



A 1.8-liter six-speed manual model with a wine red body and beige soft-top. Only 750 were made.

Heritage [Spain]

2004



A special version offered with 15-inch wheels, beige leather seats, and wood trim on the steering wheel, shift knob and handbrake cover.

Niseko [Germany]

2008



Available in an exclusive light blue color, as well as other shades, the Niseko was equipped with a brown leather interior and a brown soft-top.

Black by MX-5 [France]

2011



A 20-off RHT-based model with a black hardtop, door mirrors, aluminum wheels, and so on. Available in green, red or white.

Kaminari [Germany]

2011



A run of 900 cars featuring exclusive special body colors, special alloy wheels, and gray leather seats.

Racing by MX-5 [France]

2012



A limited edition (only 25 numbered cars) offered with a choice of 'Brilliant Black', 'Crystal White Pearl' and 'Velocity Red' paintwork.

Sport-Tech [Spain]

2012



A limited edition with 17-inch gunmetal-painted wheels, 'Havana Brown' leather seats, and a piano black dash, amongst other features.

MX-5 Cult [Italy]

2013



With a 1.8-liter engine and the option of three body colors, the 100-off Cult came fitted with 17-inch aluminum wheels.

Sport Graphite [UK]

2013



Limited to 500 units, this model came with a choice of 'Aquatic Blue' or 'Zeal Red' paintwork combined with a 'Meteor Gray' RHT and black leather seats.

Sakura [Spain]

2014



The Sakura was fitted with beige and black leather seats, an Alpine navigation system, and silver door mirrors.

Sport Venture [UK]

2014



This model was available in two new colors, 'Titanium Flash' and 'Deep Crystal Blue', with the package being completed via a set of 17-inch alloy wheels.

Global MX-5 Cup Car [USA]

2016



The MX-5 Cup car, with the same specification worldwide. Based on the North American left-hand drive model, it is fitted with a 2.0-liter engine.

Several special show models have been displayed on Mazda stands at motor shows around the world. A large number of those exhibited received performance enhancements and other modifications.

1989



Club Racer [USA]

Designed by Mazda North America (MANA), the bright yellow Club Racer made its debut alongside the mass-production model at the Chicago Auto Show in 1989, garnering a great deal of attention. In addition to the headlights gaining transparent resin covers, the car was also fitted with a large rear spoiler, Panasport wheels, and Bilstein shock absorbers to improve handling.

1995



M-Speedster [USA]

Unveiled at the 1995 Chicago Auto Show, this model featured a 1.8-liter supercharged engine that generated 200PS to endow the two-seater open car with the kind of performance one had a right to expect from its race-inspired exterior and cockpit. Using uprated suspension components, large-diameter brakes, and 215/50 ZR15 tires mounted on five-spoke alloy wheels, it offered users a particularly enjoyable drive.

2000



Mono-Posto [USA]

Taking its name from the Italian word for single-seater, this model was announced at the SEMA Show at the end of 1999, and was also displayed at the more mainstream 2000 Los Angeles Show at few weeks later. Based on the second generation body, it has a retro-style intake in the bonnet (hood), feeding air to the 190PS turbocharged engine, a low windscreen, and an integrated aluminum rollbar. With uprated brakes and suspension parts, it was the perfect expression of Jinba-ittai from the driver's viewpoint.

2001



MX-5 MPS [Japan]

The MPS (Mazda Performance Series) concept was first shown at the 2001 Tokyo Auto Salon, and updated in time to be displayed at the Frankfurt Motor Show later in the year. The car that made its debut in Frankfurt (seen here) was equipped with a tuned 1.9-liter version of the BP engine that produced no less than 200PS. It also had an adjustable suspension, and a body kit installed to improve aerodynamics and clear the 17-inch wheels and tires.

2003



Ibuki [Japan]

Ibuki means "to breathe new life" in Japanese, and this concept car was intended to return the Mazda roadster to its origins. Making its debut at the 2003 Tokyo Motor Show, it predicted the future of the MX-5 two-seater, with flowing body lines and the inclusion of lightweight materials. In addition, the 180PS 1.6-liter engine was linked to the latest technology, including a hybrid system, regenerative brakes, and an idling stop feature.

2009



Superlight Version [Europe]

This show model utilized Mazda's advanced technology to improve not only power and handling, but also fuel consumption (along with a reduction in CO2 emissions) in order to achieve high performance levels whilst at the same time being friendly to the environment. It combined a bold exterior with a sporty chassis that further increased the pleasure of driving that is unique to an open car. This extremely light machine (weighing only 993kg) was designed at the Mazda Design Center in Germany, and was exhibited at the 2009 Frankfurt Motor Show.

2011

**Super 20** [USA]

Making its debut at the 2010 SEMA Show, the Super 20 was a concept car mounted with a 2.0-liter supercharged engine that generated 243PS. Fitted with a hardtop, Mazdaspeed adjustable shock absorbers, high performance brakes and an exhaust system manufactured by Racing Beat, it originally had a matt gray exterior, but was given the orange paintwork seen here in time for the 2011 SEMA Show.

2012

**MX-5 GT** [UK]

This concept car was commissioned by Mazda UK to commemorate the MX-5 GT4 competing in the UK GT Championship series. Built by the UK-based race specialists, Jota, it had a 2.0-liter engine tuned to deliver 205PS, and adopted a suspension that could be adjusted to suit various road conditions. First exhibited at the Goodwood Festival of Speed in the UK, its popularity at the event led to the decision to release it as a limited production model.

2012

**Super 25** [USA]

Announced at the 2012 SEMA Show, the motorsports-inspired Super 25 was designed with endurance racing in mind. As a result, PIAA 40-series halogen lamps were installed on the car's nose in order for it to compete in 24-hour races. The bucket seats, full harness seatbelts and steering wheel were all built to race specifications. It sports the number '55' to pay homage to the Mazda 787B's victory at Le Mans in 1991.

2015

**Spyder** [USA]

Inspired by minimalism and the 2011 concept car of the same name, this fourth generation model features a bikini top, 'Mercury Silver' paintwork, a carbonfiber body kit, lightweight 17-inch alloy wheels, a maroon leather interior, and a whole host of other features. It was revealed at the 2015 SEMA Show held in Las Vegas, making its debut alongside the Speedster.

2015

**Speedster** [USA]

Returning to the basic essence of the traditional roadster, this car replaced the front window with a nostalgic wind deflector to fully enable the driver to feel the wind. In order to bring the weight of the car down to a minimum, it adopted some thorough weight-saving techniques, such as adopting carbonfiber doors and seats, and Rays-made 16-inch aluminum wheels. It also featured a height adjustable suspension that allowed the vehicle to ride 30mm lower than the production model.

2016

**Speedster Evolution** [USA]

Following on from the Speedster concept revealed in 2015, this model received further improvements such as lightweight brakes, a lithium battery, and a simplified dashboard to achieve even more weight reduction. The designers were able to slash 45kg over the previous model, achieving a vehicle weight of just 900kg.

2016

**RF Kuro** [USA]

Unveiled alongside the Speedster Evolution at the 2016 SEMA Show, the RF Kuro (with 'kuro' meaning black in Japanese) adopted a distinctive semi-matt 'Satin Black Metallic' body color. It was also packed with technologies adopted from the Global MX-5 Cup car, such as height adjustable suspension and Brembo brake calipers. However, it was not a circuit-oriented model, aimed instead at fusing usability and elegance in everyday life.

Situated in a distinctive post-modern building designed by Kengo Kuma in Tokyo's trendy Setagaya district, the M2 Incorporated subsidiary was established in December 1991, its display area, meeting rooms and shop operating as a direct communication channel for Mazda's customers, resulting in the creation and sale of specialized products.



Special Roadsters From M2's Workshop

The beauty of the M2 studio was the ability for customers and Mazda fans to talk directly to engineers and product planners, giving their opinion on the M2 experimental vehicles and the various ideas on display. Car clubs were encouraged to use the M2 facilities, ensuring a steady flow of market research. This contact was crucial in the development of new machines, as well as the improvement of existing ones.

As it happens, work had been going on behind the scenes for many months, allowing the M2 concern to have its first vehicle ready for the grand opening of the building at the end of 1991 – the MX-5 roadster-based M2 1001. This high-performance model, designed to attract enthusiastic drivers, was limited to 300 units, but in the end a lottery system had to be devised, as it was heavily oversubscribed.

The 960kg M2 1001 was followed by another first generation roadster-based model, the M2 1002. This featured softer tuning and a high-quality interior that brought together LWS appeal and craftsmanship. The final MX-5 limited edition model was the sporty M2 1028, which was based on the 1.8-liter platform.

Plans For Other Models

In addition to the three MX-5 Miata-based cars already mentioned, there was also the M2 1006 (a wide-body MX-5 with a 3-liter V6 engine transplant and uprated suspension), the M2 1008 coupe, and the M2 1031 – a roadster with controls set in such a way as to enable a wheelchair user to enjoy the LWS experience. These were one-off machines.

Other Mazdas also received the M2 team's attention, including a camping car conversion with an extending roof (M2 1024) that went into production, but time was running out for the M2 organization, with the project reluctantly coming to an end in April 1995.

There were many beneficial aspects to the M2 venture, however. More than anything, it was the direct contact with customers that enabled the Mazda brand to evolve. This close connection between users and the factory represents the forerunner of today's popular 'Be a driver. Experience' events, held up and down Japan, throughout the year, and helping to shape the company's future designs and products.

The MX-5-based M2 models:



M2 1001

Orders for the 300 cars were taken in December 1991, with deliveries beginning in March 1992. Linked to a 5MT gearbox, the B6 engine had a c/r of 10.7:1, a lightweight flywheel, plus a modified ECU and exhaust system, to deliver 130ps at 6,500rpm, along with 15.1kg-m of torque at 5,500rpm. It featured updated chassis and suspension parts, PAS, wider tires on 15-inch alloys, a rollover bar, and a number of sporty exterior and interior touches.



M2 1002

Announced at the end of 1992, a total of 100 M2 1002s were built, each car featuring a high-grade wood and leather interior treatment. Other changes included a subtle front spoiler and a fresh set of alloy wheels.



M2 1028

The final production MX-5 roadster-based M2 model was the 1.8-liter M2 1028, of which 300 were built. This 140ps car came with a lightweight version of the detachable hardtop (there was no soft-top), and a host of measures to further reduce bulk, such as an aluminum bootlid and forged alloy wheels. In all, the savings added up to a weight reduction of 50kg.



The M2 sign remains even though the building has been transferred to a new owner.

From its introduction in 1989, the MX-5 was rapidly accepted into the world of grassroots motorsports as an affordable lightweight sports car. In Japan, in the same year, the Media 4-Hour Endurance Race was begun with the aim of sharing the joy of driving the MX-5 with people in the media. This event, which at the time Mazda sought to associate with their efforts in the 24 Hours of Le Mans, was later developed into the Party Races, where regular customers could enjoy racing in numbered MX-5s. The MX-5 symbolized the joy of driving Mazda proposed, as well as their never-stop-challenging spirit, and has developed into the optimal tool for customer motorsports.

Spec Miata and the Ladder System

When the first Mazda MX-5 Miata was revealed to the world at the Chicago Auto Show in February 1989, an SCCA (Sports Car Club of America) white bodied roadster with a roll cage and bucket seats was also exhibited. The race car exhibited here was in the planning stage and was based on the assumption that there would be demand for a race model.

After that, Mazda North America (MANA, later Mazda North American Operations MNAO) started supplying racing certified parts and developed a one-make race Spec Miata series to be held in all US states. The series, where drivers first competed using the first generation car, was highly successful, and along with the second generation, more than 10,000 race spec Miata race cars were purchased throughout the United States. For the 30 years since it was first introduced, the race car has been handed down from parent to child, from senior to junior, and a lot of Spec Miatas are still currently active in SCCA and NASA (National Auto Sports Association) Sunday races. MNAO has since launched a scholarship system to discover and develop competent racing drivers from the Spec Miata series, which is the foundation for today's Mazda USA Motorsport's Ladder System.

Mazda USA has developed a racing driver training system called Mazda Road to 24 in recent years. This gives step-up opportunities to excellent drivers who have won the spec Miata series, offering scholarships and race support activities.



Spec Miata race

Taking the Mazda MX-5 Cup Global

MNAO currently supports the Mazda MX-5 Cup series that was launched in 2006 after the market introduction of the 3rd generation MX-5. This series targets semi-professional and high-level amateur drivers, and has produced several top drivers who compete in series in major circuits across the country. The race car also participates in the SCCA Pirelli World Challenge series and the IMSA Continental Tire SportsCar Challenge. It has achieved dynamic success, including taking class victories against strong rival machines. Based on this third generation series, MNAO announced in October 2014 the establishment of the Global MX-5 Cup, which would be competed with the 4th generation. They began receiving orders for the 4th generation MX-5 Cup car from the fall of 2015 and almost 150 cars were ordered and delivered by the next May, when the series began. The global MX-5 Cup series is truly a one-make race in which modifications and adjustments to the engine, transmission, ECU, etc. are not permitted, while the tires, brake pads, engine oil, etc., are completely unified. Only minor setting adjustments, such as suspension alignment is permitted, creating a fair competition that depends entirely on the skill of the driver and this has contributed to its popularity. The championship prize money consists of 200,000 US dollars, and the winner can use the money to fund motorsport activities in the next season or to train other drivers. In addition, in a world shootout, which consists of the best drivers selected from around the world, an 80,000 US dollar prize will be offered to the winner. A pilot event was held in the fall of 2016 and since 2017 it has been held as the Global MX-5 Cup Challenge.



Global MX-5 Cup

MX-5 takes on international races

Mazda UK developed the Mazda MX-5 GT4, based on the 3rd generation MX-5 and equipped with a 2L turbo engine with enhanced performance that generates 320ps and which participated in the 2012 UK GT Championship. It took 4th place in class at the race held in Nürburgring Germany in May and grabbed a 3rd place finish in June. In addition, it took a 2nd place finish in August, making it a strong entry into a championship dominated by UK entries until that year.



MX-5 GT4

In 2014, when the MX-5 celebrated its 25th anniversary, Mazda partnered with the UK's JOTA Sports and competed in the 24 Hours of Nürburgring with the 3rd generation MX-5. They competed in the V3 category, for non-supercharged unmodified vehicles with a displacement of 2L or less. They took class victory in the qualifying race held prior to the 24-hour race and were able to grab 3rd place at Nürburgring's long distance championship race. In qualifying it was able to take advantage of cornering speed to grab 4th place within 13 competitors. Despite high expectations due to their positive starting position, the team lost a lot of time during the race because of repair work required after making contact with a higher class vehicle, and about 11 hours into the race, the Mazda crashed and retired.



24 Hours of Nürburgring in 2014

Roadster Party Race proves a massive success

The Roadster Party Race was launched in 2002 as a one-make race for NR-A race grade vehicles with a registration number. Since it was first established with the second-generation model, the NR-A edition has continued to be offered for the 3rd generation and the 4th generation. It is possible to participate in the race by installing safety equipment such as a roll cage and specified tires. Also, in order to thoroughly pursue a fair and safe competition, rules such as "contact with other vehicles will result in zero points" were established, so that anyone could enjoy the race with confidence. Currently, the party race hosts series competed in each region of northern Japan, eastern Japan, and west Japan, while a combined race is held at Fuji Speedway, which sees 4th generation Roadsters gather from each region around the country.

In addition, the Mazda Fan Circuit Trial, where vehicles with a registration number can compete in a time attack, and the Mazda Fan Endurance, where fans compete for two and half hours beginning with a full tank of gas but are not permitted to refuel, are also held throughout Japan.

Many Roadster users also participate in local series held at various circuits throughout the country.



Roadster Party Race contenders

Consecutive wins at the Super Taikyu

The 3rd generation Roadster has also been competing in the S-4 class for 2L non-supercharged vehicles in the Super Taikyu, a popular touring car race series for semi-professional and high-level amateur racers. Since 2016, it went from seeing three to five 4th generation Roadsters mounted with Skyactiv-G 1.5 engines compete in the ST-5 class for vehicles of 1.5L displacement or less and in the last two seasons, from 2017 to 2018, the Roadster has taken the class championship.



2018 ST-5 class winner

The 30-year history of the MX-5 was made possible by the fans who love it. When the first generation was released, clubs formed by volunteers were made throughout Japan, and meetings, tours and such were held. Every weekend, in countries all over the world, you can find groups of MX-5s and their owners either driving at track day events, trying to break parade world records, or taking casual drives to nearby destinations.

In Japan, the nation-wide Roadster Club of Japan (RCOJ) was established in 1996 which, rather than lead the fans, was centered around them and created a place to enjoy the roadster freely. Currently, the club hosts and supports meetings and events throughout the country. The major feature of these fan events is that they are organized and operated by the fans themselves without Mazda taking a major role.



2015 Karuizawa Meeting, held annually since 1993

In October 1999, the Roadster 10th Anniversary Meeting was held at Mazda's Miyoshi Proving Ground, the birthplace of the Roadster. Approximately 1,000 cars from around the whole country and about 1,600 Roadster owners and fans gathered and filled the test course's 4.3 km circuit route. The event was organized by the RCOJ and allied fan club members, and many Mazda employees also volunteered to take part. During the event, members involved in the initial development related their experiences and representatives of about 80 clubs throughout the country gave speeches. There was participation not only from Japan but also from the MX-5 Owners Club UK.

In September 2009, a new addition, the 3rd generation Roadster, had been added and the Roadster 20th Anniversary Meeting was held at the Miyoshi Proving Ground just as promised 10 years ago at the same place. The number of participants increased drastically to approximately 1,600 vehicles and 2,500 people. Approximately 50 clubs gathered from all over Japan, along with members from the Miata Club of the Philippines, the Roadster Club of Thailand and the MX-5



Roadster 20th Anniversary Meeting in Miyoshi

Owners Club UK, who also participated in the 10th anniversary. All the exclusive limited models and special edition cars owned by fans were exhibited and the visitors admired just how beautifully they had all been maintained.

Fan events all over the world

In June 2013, a new Guinness World Record was set for the longest parade of Mazda cars. The setting this time was MAX-5 2013, which saw a large number of MX-5s from all over Europe gather in the Dutch city of Lelystad. According to Guinness's rules, the parade must cover a distance of at least 3.2 km (2 miles) and participating cars may not be more than two vehicle-lengths apart. At 683 MX-5s long, the Lelystad parade decisively consigned the previous record of 459 (set in Essen, Germany in 2010) to the history books.



Parade world record attempt in the Netherlands, 2013

In the United States, more than 100 MX-5 Miata clubs boasting a total of over 22,000 members are active and in regular contact with Mazda USA. Miatas at Laguna Seca is the largest gathering of MX-5s in the US and is thought to be the largest in the world. In 2014, Miatas at Laguna Seca celebrated 25 years of the Miata with a massive gathering of 1,930 cars. Fans traveled from as far away as the Netherlands, Thailand, and Japan to attend.



Miatas at Laguna Seca celebrating 25 years of the Miata, 2014

On September 4, 2014, the world premiere of the 4th generation Roadster/MX-5/Miata was held simultaneously at locations in Japan, Europe and the United States. The launches were designed to be customer-facing events and were broadcast worldwide via Ustream, allowing numerous fans to celebrate the birth of the 4th generation roadster together.



Japan (Maihama Amphitheater)

This world premiere event was held in Japan at Maihama Amphitheater near Tokyo (Urayasu city, Chiba Prefecture) and the new Roadster was revealed to fans and the media at the same time, an unusual move in Japan at the time. The 1,200 seats reserved for fans sold out in the first 10 minutes, demonstrating the level of interest surrounding the event. In addition, 250 members of the media were present and the unveiling was broadcast live via Ustream and watched by about 33,000 people around the world.



Spain (Barcelona Mazda space)

The event in Barcelona was held at 3:00 a.m. due to the time difference, but still attracted around 250 media and fans. The fourth generation MX-5 was unveiled in Soul Red along with the slogan "Long Live the Roadster." The event was covered by media from all over Europe and created a great deal of buzz.



United States (Monterey, California)

In the U.S., the world premiere was held at a purpose-made venue in Monterey, California and due to the large time difference with Japan, started at 6:00 p.m. on September 3. The fourth-generation MX-5 Miata was unveiled before a gathering of 500 media, fans and VIPs and again the event was webcast live. Three days later on September 6, Roadsters and fans gathered from around the U.S. and Canada to celebrate the 25th anniversary and the birth of a new MX-5 Miata.

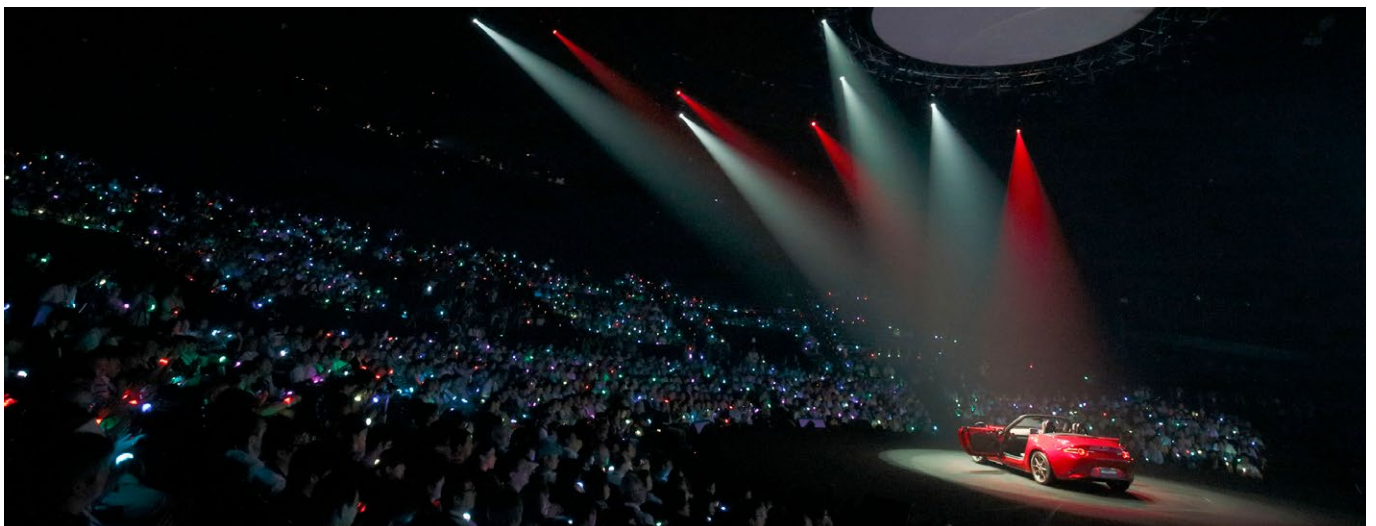

By working closely with automotive journalists and the media, Mazda hopes to share its unique driving pleasure with people around the world. We create programs that offer news about the MX-5 at major motor shows and other events around the world. Media races and other competitive events inspire teamwork and competitive spirit and the articles that results from these experiences are a great way to convey the “Lots of Fun” idea behind the MX-5 to owners and fans.

Media 4-Hour Endurance Race

Every autumn since the first Roadster was released in Japan in 1989, a four-hour endurance race has been held at Tsukuba Circuit on the outskirts of Tokyo, mainly for members of the automotive media. Teams compete in Roadsters with uniform specifications and concentrate on lasting the full four hours,



The first Media 4-Hour Endurance Race was held in 1989

which requires both driving skill and teamwork. There is a limit on the amount of fuel teams can use and, for safety, a set amount of time is designated

for refueling. Strategy is important, as are stable lap times. It is not unusual for teams to push too hard and run out of gas towards the end of the race.

Each year, Mazda enters a team comprising executive officers, test drivers and engineers, and competes seriously against the media teams. The Media 4 Hours Endurance Race has an unprecedented history for a public relations event of this type. It has been held 29 times since 1989. The only exception was 1991, a year in which the PR team was kept extremely busy after Mazda won the 24 Hours of Le Mans with the rotary-powered 787B.

European Media MX-5 Open Race

In February 2010, to mark the 20th anniversary of the launch of the MX-5 in Europe, a European version of the one-make Roadster competition, also a 4-hour endurance race, was held at Adria International Raceway in Italy. Members of the media from various European countries took part and designers from Mazda Motor Europe developed unique, country-specific



Ice Race in Sweden, 2011

color schemes for each of the 29 Roadsters that raced. Apart from the roll cage, hard suspension, and slick tires, the cars bore almost completely

standard specifications. Again the race rules put a limit on total fuel use. In the end, the Belgian team was victorious, with second place going to Portugal and third to Hungary.

In February 2011, utilizing the same 3rd generation MX-5s that had been in action the previous year, an Ice Race for mainly European media was held at Lake Kallsjön in Sweden’s mid-west. Twenty-six teams participated and enjoyed the 2-hour ice race. In the race, the Russian team, with plenty of experience driving on ice, was ultimately victorious, but the Australian team, the only one from the southern hemisphere, battled hard to take second place and the steady Belgian team finished third.

New York International Auto Show and 4th-generation MX-5 Miata

At the New York Auto Show held in April 2014, the 3rd generation-based Mazda MX-5 Miata 25th Anniversary Edition was announced, while the Skyactiv chassis that had been under



SKYACTIV Chassis on display at NAIAS 2014

development for the next-generation model was revealed for the first time. Comprising both engine and chassis, the display created quite a stir as the first example of a Skyactiv model in

the front mid-ship engine, rear wheel drive layout. Following the introduction of 4th-generation MX-5 Miata in 2015, Mazda made news at the New York International Auto Show again in 2016 with the world premiere of the Mazda MX-5 RF. At the same show, the 4th-generation Mazda MX-5 Miata was awarded a double crown, winning both World Car of the Year and World Car Design of the Year. Everyone who participated, including people from the headquarters in Japan and Mazda North America Operations, as well as Mazda distributors and dealers, were privilege to celebrate the award together with the assembled media and enthusiastic Mazda fans.

Mazda MX-5 named 2016 World Car of the Year and World Car Design of the Year

The 4th-generation MX-5 was awarded 2016 World Car of the Year (WCOTY). At the same time, in a first for a Japanese car, the model also won World Car Design of the Year (WCDOTY), a special prize granted by the same organizing body, World Car Awards. It was the first time in the history of the awards that the same model won both WCOTY and WCDOTY.

The 4th generation MX-5, sales of which started globally in 2015, has received a great deal of positive feedback from customers due to its lighter weight, its human-focused design, and its Jinba-ittai driving pleasure. Along with the 2015-2016 Japan Car of the Year and the 2016 UK Car of the Year, it has also received about 80 other awards.

The WCOTY is an international car award established in 2004 by automobile journalists from around the world. In 2016, the winner was selected by a panel of judges comprising 73 automotive journalists from 23 countries. The MX-5 was selected as a top-three finalist alongside two German rivals, with the final result announced on March 24 at the New York International Auto Show. In addition, the MX-5 was also selected alongside Mazda's own CX-3 and a British car as a top-three finalist for WCDOTY, a special award recognizing excellence in car design.



Awards for the MX-5 worldwide

Since its release in 1989, the MX-5 has won awards in various fields in countries all over the world. The original model received 80 awards from authorities, media and other organisations, including American Automobile of the Year. The second generation received 38 awards, and the third received

83, including the 2005-2006 Japan Car of the Year and the 2005 Japan Design Award. Including the 80 bestowed on the 4th-generation model, the car has been honored with more than 280 awards thus far.

Model	Major Awards
First Generation	1990 American Automobile of the Year, 1990 Denmark Prize of Honor 1991, 1990 New Zealand Car of the Year Other Awards: United States: 35; UK: 6; Germany: 7; Australia: 17; Japan: 8; Israel: 3; Hong Kong: 1
2nd Generation	2001 Japan Automobile Color Award Grand Prix, 1998 Institute of British Carriage and Automobile Manufacturers Auto Design Award Other Awards: USA: 12; UK: 12; New Zealand: 2; Portugal: 2; Denmark: 2; Australia: 1; Canada: 1; Hungary: 1; Israel: 1
3rd Generation	2011 Singapore Car of the Year, 2006 World Car of the Year top-3 finalist, 2006 New Zealand Car of the Year, 2005 Japan Design Award, 2005 Japan Car of the Year, 2005 Good Design Award Other awards: USA: 29; UK: 12; Canada: 6; Germany: 6; Japan: 4; Australia: 4; New Zealand: 3; Thailand: 3; Hungary: 2; Chile: 1; Indonesia: 1; Hungary: 1; Slovakia: 1; Ireland: 1; Philippines: 1; Croatia: 1; Hong Kong: 1
4th Generation	2016 World Car of the Year, 2016 World Car Design of the Year, 2016 UK Car of the Year, 2015 Japan Car of the Year, 2015 Europe Product Design Award Other awards: USA: 22; Japan: 11; UK: 8; Hong Kong: 7; New Zealand: 5; Belgium: 5; Canada: 4; Philippines: 4; Singapore: 3; Germany: 2; Portugal: 2; Australia: 2; Mexico: 1; Spain: 1; Malaysia: 1; Other: 1

With the noble aim of allowing enthusiasts to enjoy their cars for longer, following a huge amount of research with specialists, suppliers and fans of the marque, Mazda started looking into the reproduction of certain first generation Roadster parts in the summer of 2017, and duly announced an extensive restoration service for the model at an event held in December that year.

Anyone lucky enough to attend the event, which was heavily oversubscribed, was able to listen to an inspiring speech stating that the proposed level of restoration work was far deeper than a simple repair – it involved bringing the car back to as-new condition via craftsmen and top quality materials, and was to be carried out with the same kind of passion owners had for their vehicles. In Western countries, where the restoration of classic cars is commonplace, there was nothing unusual in these words. But for Japan, to encourage the use of older vehicles is basically a new philosophy...

The Restoration Service

The restoration service is carried out by Mazda E&T – a subsidiary that looks after body development and research, as well as Mazda’s motor show concept cars and other special editions. Staffed by experienced Mazda technicians, certified by TÜV Rheinland Japan, and backed-up by know-how from one of Germany’s leading restorers, the team aims to rebuild around six cars every year.

Customers are able to make a request for the restoration service via a special website, with a face-to-face meeting following for successful applicants. This meeting establishes the best way forward to suit the customer and the condition of the vehicle. The basic menu starts at 2,500,000 yen (including tax), with several options available to ultimately create what amounts to a brand new car.

The basic package includes a new bonnet (or hood) and bootlid (trunk), new front fenders and doors, any minor repairs necessary to other areas of the body, and a full respray. The car is then put back together with new lights, wipers, and a brand

new soft-top. Owners could also request an interior restoration (700,000 yen upwards) including new dashboard trim, seat facings and carpeting; an engine and powertrain overhaul (starting at 800,000 yen) including an engine rebuild with several new intake, exhaust and cooling parts changed, and an exchange transmission and driveshaft, and a suspension rebuild that included new suspension parts, bushes, bearings and braking components, with the price starting at 400,000 yen.

The finishing touches were possible via an air conditioning system overhaul, and a set of original specification 14-inch alloy wheels shod with Bridgestone SF325 tires. Any work and new parts are covered by a one year or 10,000km warranty.

Currently, the restoration service is limited to 1.6-liter Roadsters in Japan, grades including the basic model, Special Package, V Special and J Limited in their standard colors. Other limited editions, the 1.8-liter and M2 cars are not covered by the scheme, but plans are in motion to include them in the future.

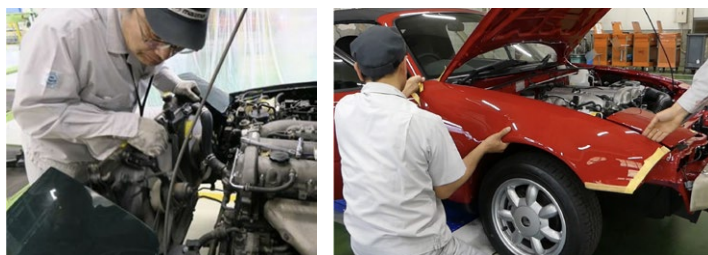

Reproduction Parts

With the intention of allowing customers to enjoy their first generation cars for longer, Mazda commissioned the reproduction of a number of components to OE specifications. A study on current availability revealed the necessity to remake around 170 different items. Sales of these parts began through domestic Mazda dealers in January 2018, with supplies to other countries following over the next few months.

More parts are in the pipeline, but, for the time being, those already available are making a big impression. A good example is the 185/60 R14 SF325 tire, originally for the Japanese market, which has been remanufactured by Bridgestone using the latest technology and techniques, whilst retaining the character of the original rubber through similar tread patterns and sidewall designs. This perfectly replicates the pleasing handling manners of the car when it was new.

The soft-top has also been remade. For this, a new vinyl covering was sourced from America, as the original German material was no longer available. It looks and feels just the same but in its latest remanufactured form, the new top clears even today's strict quality control standards.

Other components were brought back to life via Nardi of Italy, who remanufactured the V Special's elegant wood-rimmed steering wheel and matching mahogany shift knob. The Nardi badge that acts as the horn button in the center of the wheel was also remade for the project.

No detail was overlooked, with even labels being on the list, for instance. These may be minor items, but they give the new floor mats an authentic appearance.

Handover Of The First Restored Car

The first car to be completed by Mazda's restoration team was handed back to its owner at a special ceremony held at the Hiroshima head office in August 2018. This customer had bought the V Special model brand new 26 years earlier, and chose the restoration service in order to prolong his enjoyment with the vehicle. Indeed, he stated that he'd like to keep driving it for another 20 years, and then donate it to Mazda!

MX-5 Ambassador and project leader on the restoration scheme, Nobuhiro Yamamoto, was delighted with the results of the first restoration, and equally delighted with the client's reaction at seeing his rebuilt car. Yamamoto said: "This is a great day, and just the beginning, as we intend to reproduce parts for other classic Mazdas as well. This project has allowed us to get close to our customers. It's our way of saying thank you for their unwavering support, for it's their input that has shaped our products."



Handover ceremony at Mazda headquarter



Bridgestone tire and Enkei alloy, both reproduced and refined



Reproduced soft-top



Nardi steering wheel and knob

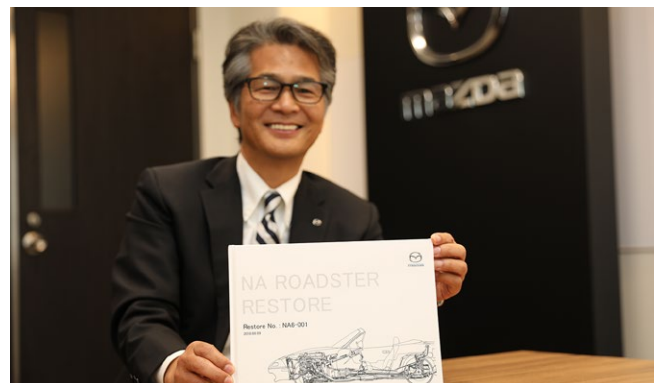

MX-5 Ambassador handing out the restoration record book



Driving to the future – more decades on

SPECIFICATIONS

Specifications in the charts below are for the Japanese Market.



1st- Generation (September 1989 – December 1997)

Body Type	Two Door Open Top			
Model	Eunos E-NA6CE *1		Mazda E-NA8C*1	
Engine	B6-ZE[RS] *1		BP-ZE[RS]	
Transmission	5MT	4AT	5MT	4AT(EC-AT)
Drive System	2WD(FR)			

■ Dimensions and Weights

Length x Width x Height	mm	3,970 x 1,675 x 1,235		3,955 x 1,675 x 1,235	
Leg room, Shoulder room, Head room	mm	935 x 1,320 x 1,025			
Wheelbase	mm	2,265			
Front Track/Rear Track	mm	1,405/1,420			
Ground Clearance	mm	140			
Vehicle Weight	kg	940	1,000	990	1,020
Seating Capacity		2			

■ Performance

Turning Radius	m	4.6			
Fuel Economy 10 mode	km/L	12.2	10.2	12.4	10.2
City mode Fuel Economy	km/L	18.5	18.3	18.9	18.8
Steering Type		Rack and Pinion			
Steering Power Assist		Engine Speed Sensitive Power Assist			
Suspension Type		Double Wishbones			
Shock Absorber		Tubular Double Acting			
Stabilizer		Torsion Bar			
Front Brakes		Ventilated Disc			
Rear Brakes		Solid Disc			
Brake Power Assist		Vacuum Booster			
Tire Front / Rear		185/60R14 82H *2			
Wheel Front / Rear		14 x 5.5J		14 x 6J *2	

■ Engine

Model		B6-ZE(RS)		BP-ZE(RS)	
Type		Inline 4 Cylinder Water-cooled DOHC 4 valves per cylinder			
Bore x Stroke	mm	78.0 x 83.6		83.0 x 85.0	
Total Displacement	cc	1,597		1,839	
Compression Ratio		9.4	9.0	9.0	
Maximum Power (Net)	ps/rpm	120/6,500	110/5,500	130/6,500	
Maximum Torque	kg-m/rpm	14.0/5,500	14.0/4,500	16.0/4,500	
Carburation		Electric Gasoline Injection (EGI)			
Fuel Requirement, Fuel Tank Capacity	L	Unleaded Regular 45		Unleaded Regular 48	
Clutch Type		5MT Single Dry Plate Diaphragm Spring		4AT Lock-up Torque Converter	
Gear Ratio	1st	3.136	2.841	3.136	2.458
	2nd	1.888	1.541	1.888	1.458
	3rd	1.330	1.000	1.330	1.000
	4th	1.000	0.720	1.000	0.720
	5th	0.814	–	0.814	–
	Reverse	3.758	2.400	3.758	2.400
Final Gear Ratio		4.300		4.100 *2	

* 1 In January 1993 the car name / model was changed from Eunos E-NA6CE to Mazda E-NA8C, engine changed from B6-ZE (RS) to BP-ZE (RS)

* 2 Changed final gear ratio to 4.300 (5 MT) in August 1995, plus additional tire settings of 195/50 R15 and 15x6J wheels

2nd-Generation (January 1998 – August 2005)

Body type	2 door open top					
Car name / model	Mazda GF-NB6C			Mazda GF-NB8C		
engine	B6-ZE[RS]			BP-ZE[RS]		
Model name	Standard	M package	Special package	S	RS	VS
Transmission () is 4 AT	5MT	5MT(EC-AT)		6MT(EC-AT)	6MT	6MT(EC-AT)
Drive system	2WD(FR)					

■ Dimensions and Weights

Length x Width x Height	mm	3,955 x 1,680 x 1,235				
Leg room, Shoulder room, Head room	mm	865 x 1,355 x 1,025				
Wheelbase	mm	2,265				
Front Track/Rear Track	mm	1,405/1,430		1,415/1,440		
Ground Clearance	mm	135				
Vehicle weight () for 4 AT		1,010	1,020(1,040)		1,030(1,060)	1,030
Seating Capacity		2				

■ Performance

Turning Radius	m	4.6				
Fuel Economy 10 mode	km/L	14.8	14.2(12.0)		13.0(11.4)	13.0
60 km/h fixed fuel consumption	km/L	20.3	20.3(19.1)		19.0(19.0)	19.0
Steering Type		Rack and Pinion				
Steering Power Assist		–	Integral power steering			
Suspension Type Front / Rear		Double Wishbones				
Shock Absorber Front / Rear		Tubular Double Acting				
Stabilizer Front / Rear		Torsion Bar				
Front Brakes		Ventilated Disc				
Rear Brakes		Solid Disc				
Brake Power Assist		Vacuum Booster				
Tire Front / Rear		185/60H14 82H			195/50R15 82V *	185/60H14 82H
Wheel Front / Rear		14 x 5 1/2J		14 x 6J	15 x 6J *	14 x 6J

■ Engine

Model		B6-ZE(RS)		BP-ZE(RS)		
Type		Inline 4 Cylinder Water-cooled DOHC 16 valves per cylinder				
Bore x Stroke	mm	78.0 x 83.6			83.0 x 85.0	
Total Displacement	cc	1,597			1,839	
Compression Ratio		9.4			9.5 *	
Maximum Power (Net)	ps/rpm	125/6,500			145/6,500 *	
Maximum Torque	kg-m/rpm	14.5/5,000			16.6/5,000 *	
Carburation		Electric Gasoline Injection (EGI)				
Fuel Requirement, Fuel Tank Capacity	L	Unleaded Regular 48				
Clutch Type		5MT /6MT Single Dry Plate Diaphragm Spring		EC-AT 3 Element 1 Stage 2 Phase Lock-up Torque Converter		
Gear Ratio	1st	3.136	3.136(2.450)		3.760(2.450)	3.760
	2nd	1.888	1.888(1.450)		2.269(1.450)	2.269
	3rd	1.330	1.330(1.000)		1.645(1.000)	1.645
	4th	1.000	1.000(0.730)		1.257(0.730)	1.257
	5th	0.814	0.814(–)		1.000(–)	1.000
	6th		–		0.843(–)	0.843
	Reverse	3.758	3.758(2.220)		3.564(2.220)	3.564(2.220)
Final Gear Ratio		4.300			3.909(4.100)	3.909

* July 2000 to tire 205 / 45R16 83W, wheel 16 x 6 1 / 2J, compression ratio 10.5, maximum output 160PS / 7,000rpm, changed to the maximum torque 17.3kg-m / 5,500rpm

3rd-Generation (August 2005 – May 2015)

Body type	2 door open top					
Car name / model	Mazda CBA-NCEC					
engine	LF-VE					
Roof type	Soft top			Power retractable hard top		
Model name	Standard	RS	VS	Standard RS	VS	VS
Transmission	5MT/6MT	6MT	6MT/6AT *1	5MT/6MT	6MT	6MT/6AT
Drive system	2WD(FR)					

■ Dimensions and Weights

Length x Width x Height	mm	3,995 x 1,720 x 1,245			3,995 x 1,720 x 1,255		
Leg room, Shoulder room, Head room	mm	875 x 1,415 x 1,045			875 x 1,415 x 1,035		
Wheelbase	mm	2,330					
Front Track/Rear Track	mm	1,490/1,495					
Ground Clearance	mm	135					
Vehicle weight () for 6AT		1,090(1,100)	1,110	1,090(1,100)	1,130(1,140)	1,140	1,130(1,140)
Seating Capacity		2					

■ Performance

Turning Radius	m	4.7					
Fuel Economy of 10 / 15 mode ()for AT	km/L	13.4(11.8)	13.0	13.0(11.8)	13.4(11.8)	13.0	13.0(11.8)
Steering Type		Rack and Pinion					
Steering Power Assist		Integral power steering					
Suspension Type Front / Rear		Double Wishbones / Multilink					
Shock Absorber Front / Rear		Tubular Double Acting					
Stabilizer Front / Rear		Torsion Bar					
Front Brakes		Ventilated Disc					
Rear Brakes		Solid Disc					
Brake Power Assist		Vacuum Booster					
Tire Front / Rear		205/50R16 87V	205/45R17 84W	205/50R16 87V	205/50R16 87V	205/45R17 84W	205/50R16 87V
Wheel Front / Rear		16 x 6.5J	17 x 7J	16 x 6.5J	16 x 6.5J	17 x 7J	16 x 6.5J

■ Engine

Model	LF-VE						
Type	Inline 4 Cylinder Water-cooled DOHC 16 valves per cylinder						
Bore x Stroke	mm	87.5 x 83.1					
Total Displacement	cc	1,998					
Compression Ratio		10.8					
Maximum Power (Net)	kW(ps)/rpm	125(170)/6,700 *2 at 6AT 122(166)/6,700					
Maximum Torque	N·m(kg-m)/rpm	189(19.3)/5,000					
Carburation		Electric Gasoline Injection (EGI)					
Fuel Requirement, Fuel Tank Capacity	L	Unleaded Regular 50					
Clutch Type		5MT/6MT Single Dry Plate Diaphragm Spring 6AT 3 Element 1 Stage 2 Phase Lock-up Torque Converter					
Gear Ratio ()for AT	1st	3.136(3.538)	3.815	3.815(3.538)	3.136(3.538)	3.815	3.815(3.538)
	2nd	1.888(2.020)	2.260	2.260(2.060)	1.888(2.020)	2.260	2.260(2.060)
	3rd	1.330(1.404)	1,640	1.640(1.404)	1.330(1,404)	1,640	1.640(1.404)
	4th	1.000(1.000)	1.177	1.177(1.000)	1.000(1.000)	1.177	1.177(1.000)
	5th	0.814(0.713)	1.000	1.000(0.713)	0.814(0.713)	1.000	1.000(0.713)
	6th	-(0.582)	0.832	0.832(0.582)	-(0.582)	0.832	0.832(0.582)
	Reverse	3.758(3.168)	3.603	3.603(3.168)	3.758(3.168)	3.603	3.603(3.168)
Final Gear Ratio		4.100					

*1 6AT = electronic controlled 6-speed automatic (active-matic)

*2 Changed to 125 kW (170 PS) / 7,000 rpm in December 2008

4th-Generation (May 2015 – Present)

Body type	2 door open top					
Roof type	Soft top			Retractable fast back (RF)		
Car name / model	Mazda 5BA-ND5RC			Mazda 5BA-NDERC		
engine	SKYACTIV-G 1.5			SKYACTIV-G 2.0		
Model name	S	S Special	RS	S	VS	RS
Transmission	6MT	6MT/6EC-AT	6MT	6MT/6EC-AT	6MT/6EC-AT	6MT
Drive system	2WD(FR)					

■ Dimensions and Weights

Length x Width x Height	mm	3,915 x 1,735 x 1,235			3,915 x 1,735 x 1,245	
Leg room, Shoulder room, Head room	mm	940 x 1,425 x 1,055			940 x 1,425 x 1,040	
Wheelbase	mm	2,310				
Front Track/Rear Track	mm	1,495/1,505				
Ground Clearance	mm	140			145	
Vehicle weight () for 6AT	kg	990	–			
	i-ELOOP+i-stop equipped	–	1,030(1,050)	1,020(1,060)	1,100(1,130)	1,100(1,130) 1,100
乗車定員		2				

■ Performance

Turning Radius	m	4.7				
Fuel Economy of WLTC mode *1	km/L	16.8	16.8	16.8		
() for AT	i-ELOOP+i-stop equipped	–	17.4(17.2)	17.4	15.8(15.2)	15.8(15.2) 15.8
Steering Type		Rack and Pinion				
Suspension Type front / rear		Double Wishbones / Multilink				
Shock Absorber front / rear		Tubular Double Acting				
Stabilizer Front / Rear		Torsion Bar				
Front Brakes		Ventilated disc				
Rear Brakes		Solid Disc				
Brake Power Assist		Vacuum Booster				
Tire Front / Rear		195/50R16 84V			205/45R17 84W	
Wheel Front / Rear		16 x 6.5J			17 x 7J	

■ Engine

Model		P5-VP[RS]			–	
	i-ELOOP+i-stop equipped	–	P5-VPR[RS]		PE-VPR[RS]	
Type		Inline 4 Cylinder Water-cooled DOHC 16 valves per cylinder				
Bore x Stroke	mm	74.5 x 85.8			83.5 x 91.2	
Total Displacement	cc	1,496			1,997	
Compression Ratio		13.0				
Maximum Power (Net)	kW(ps)/rpm	97(132)/7,000			116(158)/6,000 *2	
Maximum Torque	N·m(kgf·m)/rpm	152(15.5)/4,500			200(20.4)/4,600 *2	
Carburation		Direct cylinder injection (DI)				
Fuel Requirement, Fuel Tank Capacity	L	Unleaded Premium 40			Unleaded Premium 45	
Clutch Type		6MT Single Dry Plate Diaphragm Spring 6AT 3 Element 1 Stage 2 Phase Lock-up Torque Converter				
Gear Ratio () for AT	1st	5.087	5.087(3.538)	5.087	5.087(3.538)	5.087(3.538) 5.087
	2nd	2.991	2.991(2.060)	2.991	2.991(2.060)	2.991(2.060) 2.991
	3rd	2.035	2.035(1.404)	2.035	2.035(1.404)	2.035(1.404) 2.035
	4th	1.594	1.594(1.000)	1.594	1.594(1.000)	1.594(1.000) 1.594
	5th	1.286	1.286(0.713)	1.286	1.286(0.713)	1.286(0.713) 1.286
	6th	1.000	1.000(0.582)	1.000	1.000(0.582)	1.000(0.582) 1.000
	Reverse	4.696	4.696(3.168)	4.696	4.696(3.168)	4.696(3.168) 4.696
Final Gear Ratio		2.866	2.866(4.100)	2.866	2.866(3.583)	2.866(3.583) 2.866

*1 WLTC mode = International driving mode consisting of average specification time allocated for each driving mode in urban areas, suburbs, and on expressways

*1 Appraised value measured by the Ministry of Land, Infrastructure, Transport and Tourism = Application for designation made through the Road Vehicles Act

*1 Maximum output changed to 135 kW (184 PS) / 7,000rpm, maximum torque 205 N·m (20.9 kgf·m) / 4,000 rpm in June 2018

DIMENSIONS



1st-Generation

(Sep. 1989 – Dec. 1997)

1st-Generation Roadster/MX-5

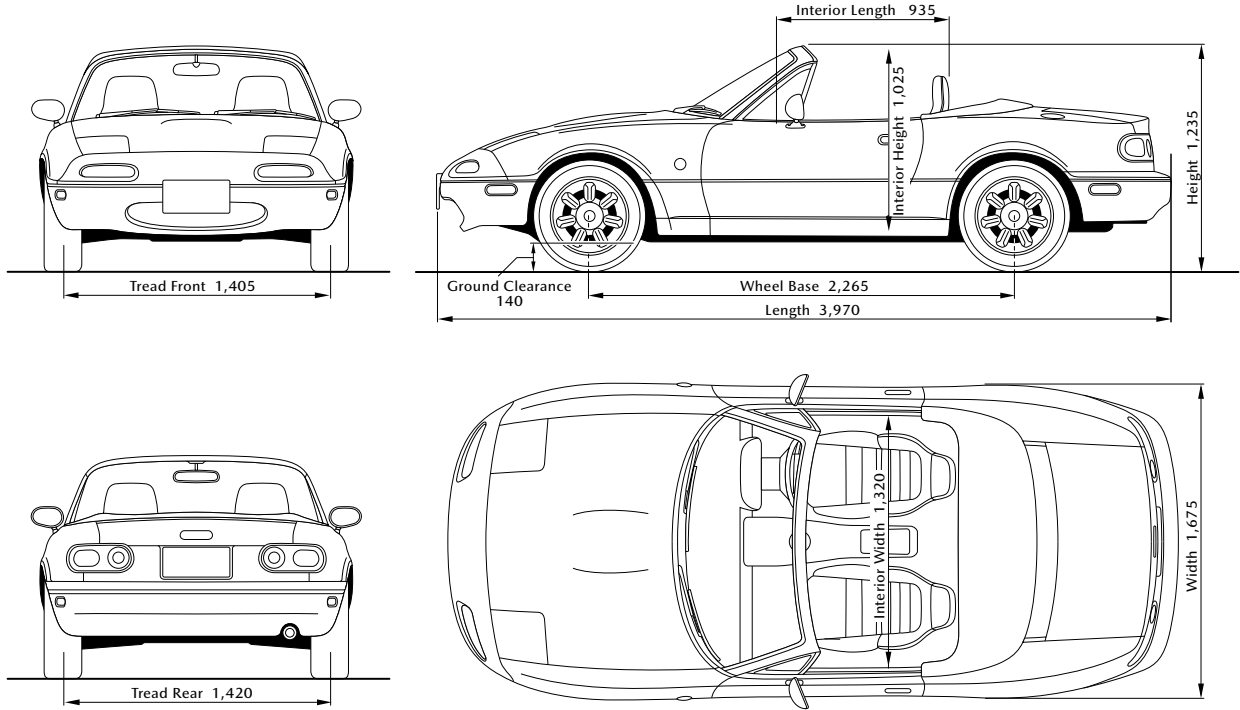

(mm)

2nd-Generation

(Jan. 1998 – Aug. 2005)

2nd-Generation Roadster/MX-5

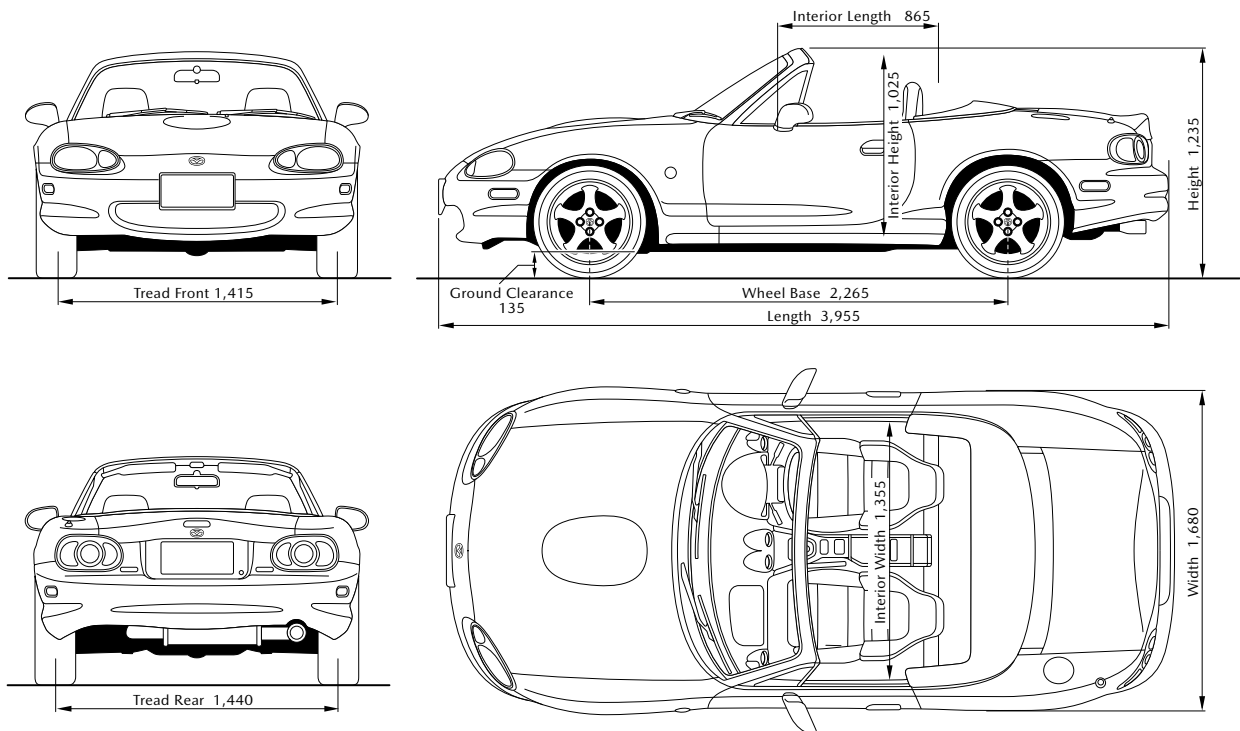

(mm)

3rd-Generation

(Aug. 2005 – May. 2015)

3rd-Generation
Roadster/MX-5

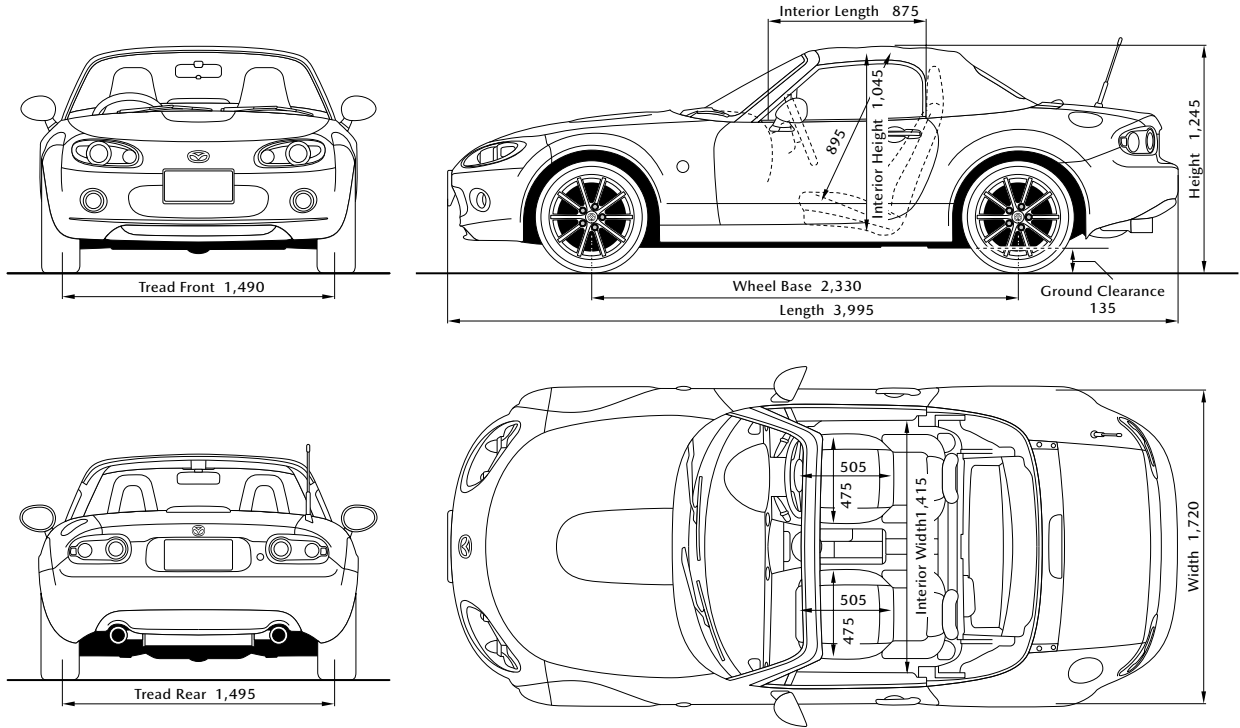

(mm)

3rd-Generation Power Retractable Hardtop Model

(Aug. 2006 – May 2015)

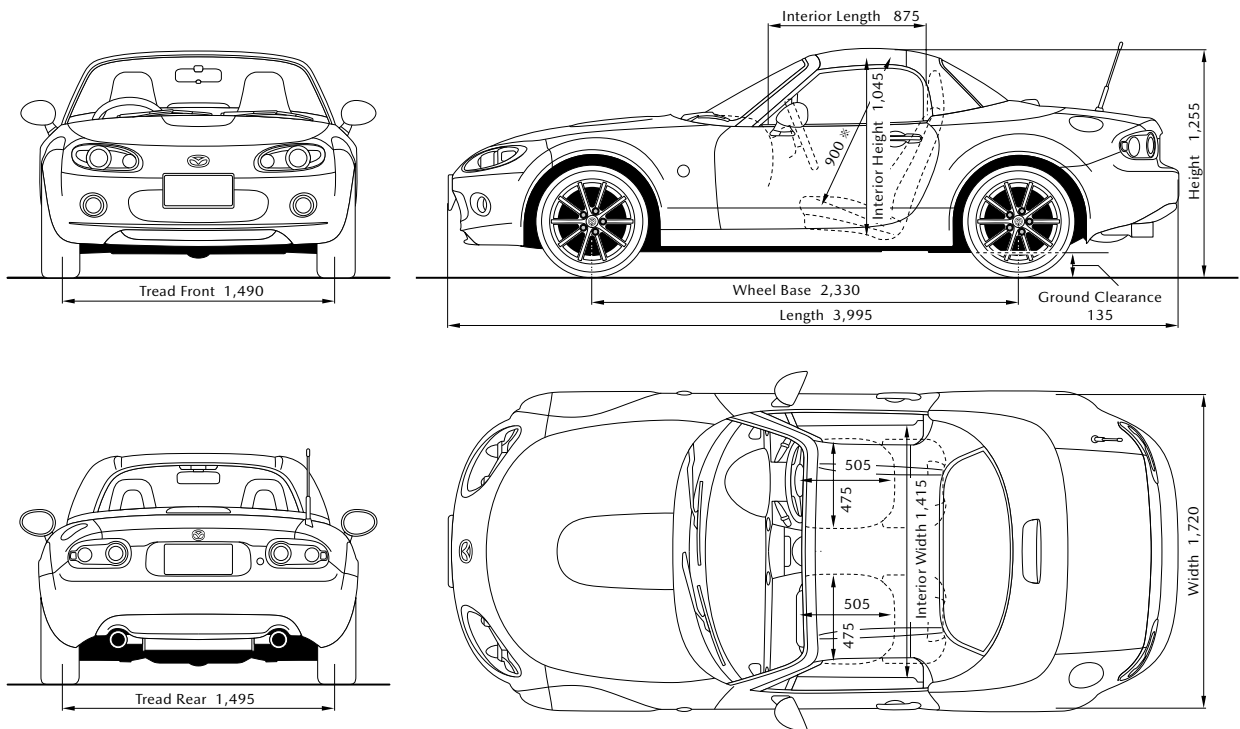

(mm)

※ For cars with a driver's seat fitted with a ratchet-lever seat lifter this will be 895mm (driver's seat only)

4th-Generation

(May 2015 – Present)

4th-Generation Roadster/MX-5

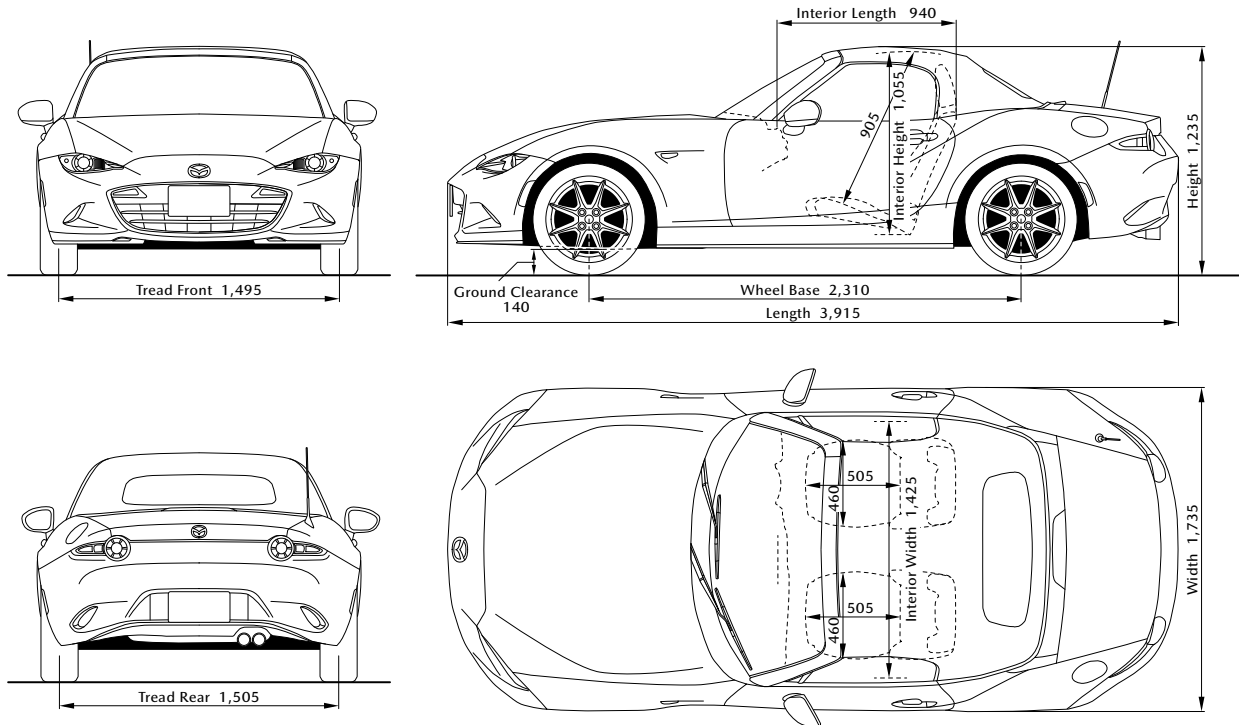

(mm)

4th-Generation RF

(Dec. 2016 - Present)

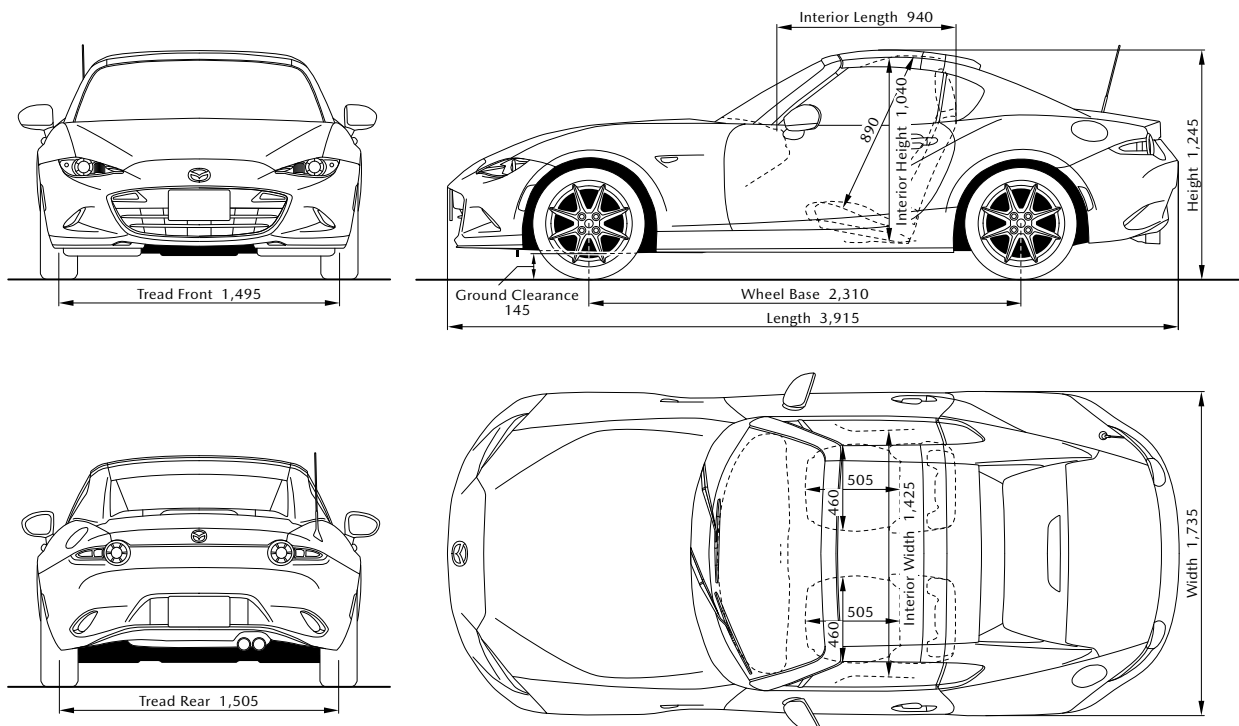

(mm)

ROADSTER / MX-5 Global Production Unit

	1st Generation	2nd Generation	3rd Generation	4th Generation	Total
1989	45,278				45,278
1990	95,640				95,640
1991	63,434				63,434
1992	52,712				52,712
1993	44,743				44,743
1994	39,623				39,623
1995	31,886				31,886
1996	33,610				33,610
1997	24,580	2,457			27,037
1998		58,682			58,682
1999		44,851			44,851
2000		47,496			47,496
2001		38,870			38,870
2002		40,754			40,754
2003		30,106			30,106
2004		24,232			24,232
2005		2,675	27,275		29,950
2006			48,389		48,389
2007			37,022		37,022
2008			22,886		22,886
2009			19,341		19,341
2010			20,554		20,554
2011			14,995		14,995
2012			15,400		15,400
2013			11,639		11,639
2014			12,246		12,246
2015			1,885	30,022	31,907
2016				40,101	40,101
2017				38,861	38,861
2018				27,452	27,452
Total	431,506	290,123	231,632	136,436	1,089,697

ROADSTER / MX-5 Global Sales Unit

	Japan	North America	Europe	Australia	China	Others	Total
1989	9,307	25,879	0	657	0	0	35,843
1990	25,226	39,850	9,267	1,455	0	0	75,798
1991	22,594	34,196	14,050	698	0	0	71,538
1992	18,648	27,241	6,632	499	0	0	53,020
1993	16,779	23,089	4,824	453	0	0	45,145
1994	10,828	22,573	5,019	404	0	0	38,824
1995	7,171	21,108	7,174	196	0	0	35,649
1996	4,409	18,966	9,585	241	0	0	33,201
1997	3,537	17,812	10,480	206	0	0	32,035
1998	10,174	20,890	16,831	1,310	0	0	49,205
1999	4,952	18,936	21,130	1,354	0	30	46,402
2000	4,644	19,627	19,268	1,038	0	33	44,610
2001	4,211	17,757	16,368	924	0	6	39,266
2002	2,934	15,622	19,670	698	0	34	38,958
2003	1,520	11,999	18,934	540	0	11	33,004
2004	1,646	10,501	13,885	483	0	248	26,763
2005	3,657	10,658	9,852	743	0	353	25,263
2006	4,067	18,479	19,402	1,468	0	827	44,243
2007	3,845	16,888	18,899	1,170	0	772	41,574
2008	1,858	12,384	13,252	639	0	610	28,743
2009	1,947	8,767	9,709	521	720	474	22,138
2010	1,120	7,106	10,317	440	652	431	20,066
2011	1,104	6,286	8,147	315	284	446	16,582
2012	941	7,016	7,207	159	75	438	15,836
2013	768	6,334	6,113	178	46	331	13,770
2014	595	5,256	5,813	118	18	362	12,162
2015	8,509	9,221	6,881	917	1	979	26,508
2016	6,126	10,368	14,145	1,577	0	2,351	34,567
2017	7,005	12,438	16,039	1,459	0	2,832	39,773
2018	5,331	9,785	13,787	820	454	1,761	31,938
Total	195,453	487,032	352,680	21,680	2,250	13,329	1,072,424

2018 December / Present

Ratio of unit sales by region

- North America
- Europe
- Japan
- Australia
- Others

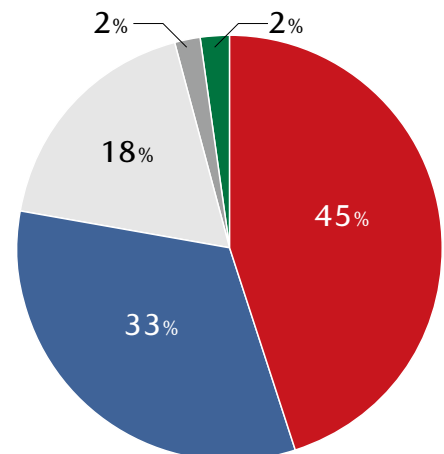

CHRONOLOGY



1983		Conceptual studies begin regarding a lightweight sports car (LWS)
	November	Commercialization preliminary review begins
1985	October	Prototype model runs at Santa Barbara, USA, demonstrating product potential
1986	February	Mass-production approved
1987	April	Focus group interviews conducted in Pasadena, USA
	September	Design freeze declared within Mazda
	October	'MX-04' two-seater LWS concept exhibited at the Tokyo Motor Show
1989	February	Roadster shown to US Mazda dealers at Nashville, Tennessee
	February	'Mazda MX-5 Miata' unveiled to public at Chicago Auto Show
	March	Mass-production begins for export-spec 'Mazda MX-5 Miata'
	May	Sales begin in the US
	July	'Eunos Roadster' reservation campaign starts in Japan
	September	Domestic market 'Eunos Roadster' released
	September	First Roadster Media 4hr Endurance Race held
	October	Sales begin in Australia
	October	Green/tan model showcased at Tokyo Motor Show
	1990	February
March		Four-speed automatic model added
July		'V Special' grade added with Neo Green paintwork and a tan leather interior
October		First Kiyosato meeting held by Roadster fans
1991	July	'J Limited' special edition released for the domestic market (800 units)
	August	Minor changes applied, including a black paint option for the 'V Special'
	December	M2 company founded, and 'M2 1001' released (300 units)
1992	July	'S Special' model released, and Sensory Sound System option added
	November	'M2 1002' released (100 units)
	December	'S Limited' special edition released, limited to 1,000 units
1993	May	First Karuizawa meeting held by Roadster fans
	July	Model revised, with a new 1.8-liter engine employed, and improvements in body rigidity, etc. The 'V Special Type II' model is added at the same time
	December	'J Limited II' special edition released (800 units)
1994	February	'M2 1028' released, restricted to 300 units
	July	'RS Limited' special edition released (500 units)
	December	'G Limited' special edition released (1,500 units)
	December	Discussions regarding the second generation model begin
1995	February	'R Limited' special edition released (1,000 units)
	August	Minor change, with a lightweight flywheel adopted, the final-drive ratio and CPU revised, etc.
1996	December	SRS airbag made standard on all domestic models. 'B2 Limited' special edition released (1,000 units) along with 'R2 Limited' (500 units)
1997	August	'SR Limited' special edition released (700 units)
	October	Second generation Mazda Roadster unveiled at Tokyo Motor Show
1998	January	Official launch of the second generation 'Mazda Roadster'
1999	January	Special '10th Anniversary' model released worldwide, with unified specifications for Japan, North America, Europe and Australia. Limited to 7,500 units globally
	October	'Roadster 10th Anniversary Meeting' held at Mazda's Miyoshi Proving Grounds
2000	January	'NR Limited' special edition released (500 units)
	May	Certified by Guinness as the "world's best-selling two-seater sports car" with 531,890 sold
	July	Model revised, with a styling facelift and enhanced power output
	December	'YS Limited' special edition released (700 units)
2001	May	'Mazdaspeed Roadster' released, limited to 200 units
	February	Internet customizing system introduced, leading to availability of the 'Web-Tuned Roadster'
	December	'NR-A' model added for motorsport enthusiasts, along with 300-off 'MV Limited' special edition
2002	March	Discussions regarding the third generation model begin
	May	First Roadster Party Race held
	July	Model revised, with a cloth soft-top adopted for the VS grade, extra body color options, etc.
	December	'SG Limited' special edition released (400 units)

2003	September	Model revised, with new BOSE sound system added, more body color options, etc.
	October	Manufacture of the made-to-order 'Mazda MX-5 Roadster Coupe' begins, with planning and production conducted by Mazda E&T
	October	'Ibuki' concept car revealed at Tokyo Motor Show
2004	February	'Mazda Roadster Turbo' special edition released (350 units)
2005	March	Third generation Roadster unveiled at Geneva International Motor Show
	April	Cumulative production reaches 700,000 units; Guinness record updated
	May	International press event for the third generation Roadster held in Hawaii
	August	Official launch of the third generation 'Mazda Roadster' at Ryōgoku Kokugikan, along with the release of the 500-off '3rd Generation Limited' model
	November	NC model wins the 2005-2006 'Japan Car of the Year' award
2006	January	'Japan Car of the Year Award Commemorative Edition' released
	April	New versions of the 'Web-Tuned Roadster' and 'NR-A' motorsports model released
	August	Power retractable hardtop model added
	December	'Blaze Edition' special edition released
2007	January	Cumulative production reaches 800,000 units
	April	'Mazdaspeed M'z Tune' special edition released
	October	'Prestige Edition' special edition released
	December	Initial discussions regarding the fourth generation model begin
2008	December	Model revised, with a front-end facelift, a higher-revving engine, and suspension improvements, etc.
2009	July	'Mazda MX-5 Miata 20th Anniversary Edition' model released
	September	'Roadster 20th Anniversary Meeting' held at Miyoshi Proving Grounds
2010	February	European Mazda MX-5 Open Race held at Adria International Raceway in Italy
2011	February	Cumulative production reaches 900,000 units; application filed for renewal of Guinness record
	March	European media Mazda MX-5 ice race held in Sweden
	October	'Black Tuned Roadster' special edition released
2012	June	Investigation of ND-series mass-production begins
	July	Model revised, with frontal changes, including the adoption of a pedestrian-friendly active bonnet as standard equipment
2013	December	Model revised, with black cloth soft-top adopted for open cars, changes to option settings, etc.
2014	April	'25th Anniversary Limited Edition MX-5' and fourth generation Roadster chassis revealed at New York International Auto Show
	June	Third generation roadster participates in the 24hr Nürburgring Race
	September	Simultaneous reveal of the fourth generation Mazda Roadster at three locations worldwide (at Maihama Amphitheater in Japan, Monterey in California, and Barcelona in Spain)
2015	May	Fourth generation 'Mazda Roadster' released
	September	New version of 'NR-A' model for motorsport use added
	October	New 'RS' grade established
	December	Fourth generation 'Mazda Roadster' wins the 2015-2016 'Japan Car of the Year' award
2016	March	The 'Mazda Roadster RF' - a fastback model with a retractable hardtop - is unveiled at the New York International Auto Show. The fourth generation Roadster wins both the 2016 'World Car of the Year' and 'World Car Design of the Year' awards (the first time the same model won both awards since they were established)
	April	Cumulative production reaches one-million units. The millionth vehicle is exhibited at fan events all over the world, with participants invited to sign it
	May	Global MX-5 Cup held for the first time in the US
	December	Production version of the 'Mazda Roadster RF' released
2017	January	Reservations begin for the limited edition 'Classic Red' model
	April	Global MX-5 Cup Japan begins
	August	Restoration service and parts remanufacturing announced for first generation NA-type Roadster
	October	Global MX-5 Cup Challenge held at Laguna Seca
	November	Model revised, with adaptive LED headlights adopted. The 'Red Top' special edition is released at the same time
2018	June	Model revised, with a telescopic steering wheel made standard for all grades, the RF 2.0-liter engine gaining a 15% power increase, and the launch of the 'Caramel Top' special edition
2019	February	Special '30th Anniversary Edition MX-5' model announced at the Chicago Auto Show



Mazda Motor Corporation
Published by: Corporate Communications Division

■Hiroshima Headquarters: 3-1 Shinchi, Fuchu-cho, Aki-gun, Hiroshima 730-8670
■Tokyo Office: 1-1-7 Uchisaiwai-cho, Chiyoda-ku, Tokyo 100-0011

MAZDA MEDIA WEB SITE
<http://www.media.mazda.com/>