

Zoom-Zoom

All children instinctively know it.

A few adults still remember it.

One unique car company refuses to outgrow it.

In grown-up language, it means the exhilaration and

liberation that come from experiencing sheer motion.

But as usual, children put it much better and simply call it " Go Zoom-Zoom."

We practice it every day.

It's why we build the kind of cars we do.

Zoom-Zoom.

Can we re-awaken it in you today?

A Word to Mazda Owners

Thank you for choosing a Mazda. We at Mazda design and build vehicles with complete customer satisfaction in mind.

To help ensure enjoyable and trouble-free operation of your Mazda, read this manual carefully and follow its recommendations.

An Authorized Mazda Dealer knows your vehicle best. So when maintenance or service is necessary, that's the place to go.

Our nationwide network of Mazda professionals is dedicated to providing you with the best possible service.

We assure you that all of us at Mazda have an ongoing interest in your motoring pleasure and in your full satisfaction with your Mazda product.

Mazda Motor Corporation
HIROSHIMA, JAPAN

Important Notes About This Manual

Keep this manual in the trunk as a handy reference for the safe and enjoyable use of your Mazda. Should you resell the vehicle, leave this manual with it for the next owner.

All specifications and descriptions are accurate at the time of printing. Because improvement is a constant goal at Mazda, we reserve the right to make changes in specifications at any time without notice and without obligation.

Air-Conditioning and the Environment

Your Mazda's genuine air conditioner is filled with a refrigerant that has been found not to damage the earth's ozone layer. If the air conditioner does not operate properly, consult an Authorized Mazda Dealer.

Perchlorate

Certain components of this vehicle such as [air bag modules, seat belt pretensioners, lithium batteries,...] may contain Perchlorate Material-- Special handling may apply for service or vehicle end of life disposal. See www.dtsc.ca.gov/hazardouswaste/perchlorate.

Please be aware that this manual applies to all models, equipment and options. As a result, you may find some explanations for equipment not installed on your vehicle.

How to Use This Manual

We want to help you get the most driving pleasure from your vehicle. Your owner's manual, when read from cover to cover, can do that in many ways.

Illustrations complement the words of the manual to best explain how to enjoy your Mazda. By reading your manual, you can find out about the features, important safety information, and driving under various road conditions.

The symbol below in this manual means "Do not do this" or "Do not let this happen".

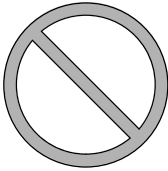

Index: A good place to start is the Index, an alphabetical listing of all information in your manual.

You'll find several WARNINGS, CAUTIONS, and NOTES in the manual.

WARNING

A WARNING indicates a situation in which serious injury or death could result if the warning is ignored.

CAUTION

A CAUTION indicates a situation in which bodily injury or damage to your vehicle, or both, could result if the caution is ignored.

NOTE

A NOTE provides information and sometimes suggests how to make better use of your vehicle.

The following symbol, located on some parts of the vehicle, indicates that this manual contains information related to the part.

Please refer to the manual for a detailed explanation.



Table of Contents

Pictorial Index

Interior, exterior views and part identification of your Mazda.

1

Essential Safety Equipment

Important information about safety equipment, including seats, seat belt system, child-restraint systems and SRS air bags.

2

Before Driving

Use of various features, including keys, doors, mirrors and windows.

3

When Driving

Information concerning safe driving and stopping.

4

Interior Features

Use of various features for ride comfort, including air-conditioning and audio system.

5

Maintenance and Care

How to keep your Mazda in top condition.

6

If Trouble Arises

Helpful information on what to do if a problem arises with the vehicle.

7

Customer Information and Reporting Safety Defects

Important consumer information including warranties and add-on equipment.

8

Specifications

Technical information about your Mazda.

9

Index

10

1

Pictorial Index

Interior, exterior views and part identification of your Mazda.

Interior Overview	1-2
Interior Equipment (View A)	1-2
Interior Equipment (View B)	1-4
Interior Equipment (View C)	1-5
Exterior Overview	1-7
Convertible Top (Soft Top)	1-7
Convertible Top (Retractable Fastback).....	1-8

Interior Equipment (View A)

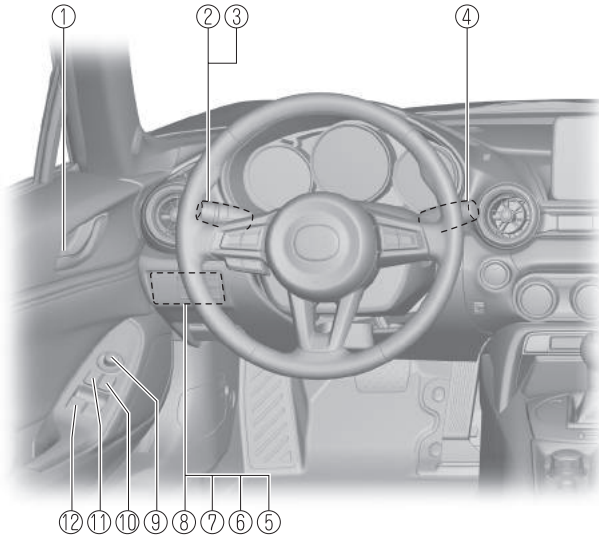

① Door-lock knob	page 3-17
② Turn and lane-change signal	page 4-50
③ Lighting control.....	page 4-45
④ Wiper and washer lever.....	page 4-51
⑤ DSC OFF switch	page 4-68
⑥ Tire pressure monitoring system set switch	page 4-108
⑦ Blind Spot Monitoring (BSM) switch.....	page 4-90
⑧ LDWS switch.....	page 4-82
⑨ Outside mirror switch.....	page 3-28
⑩ Door-lock switch.....	page 3-14
⑪ Power window lock switch	page 3-33
⑫ Power window switches.....	page 3-31

Interior Overview

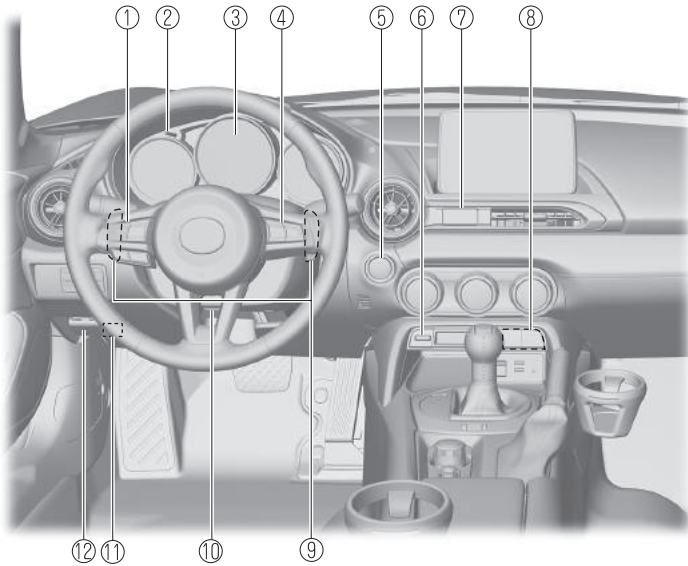

① Audio control switches.....	page 5-55
② Dashboard illumination knob.....	page 4-15
③ Instrument cluster.....	page 4-11
④ Cruise control switches.....	page 4-100
⑤ Push button start.....	page 4-4
⑥ Retractable fastback switch.....	page 3-45
⑦ Hazard warning flasher switch.....	page 4-57
⑧ Seat warmer switches.....	page 2-5
⑨ Steering shift switches.....	page 4-37
⑩ Lock release lever.....	page 3-27
⑪ Trunk release button.....	page 3-19
⑫ Hood release handle.....	page 6-24

Interior Overview

Interior Equipment (View B)

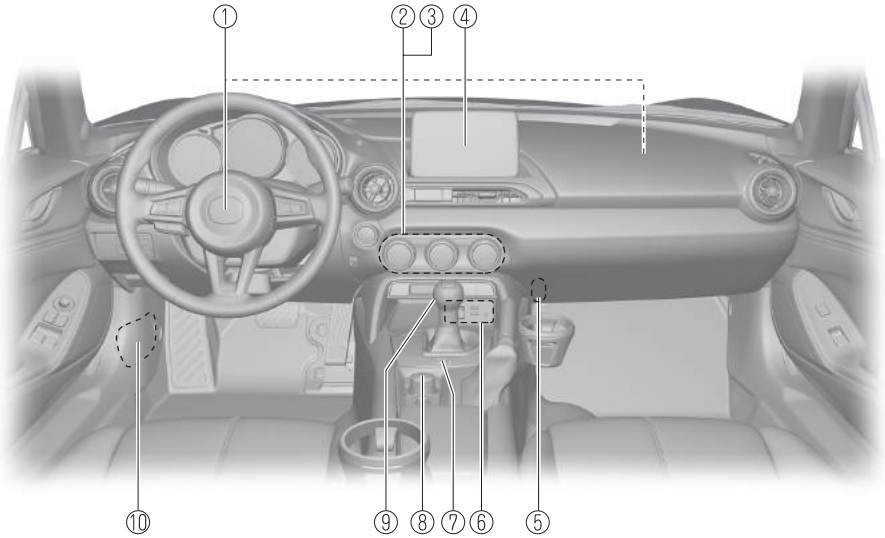

① SRS air bags.....	page 2-24
② Climate control system.....	page 5-2
③ Rear window defogger switch.....	page 4-55
④ Audio system.....	page 5-13
⑤ Accessory socket.....	page 5-134
⑥ External input terminal.....	page 5-57
⑦ Drive selection switch.....	page 4-72
⑧ Commander switch.....	page 5-34
⑨ Shift lever/Selector lever.....	page 4-31, 4-34
⑩ Fuse block (Left side).....	page 6-54

Interior Equipment (View C)

▼ Convertible Top (Soft Top)

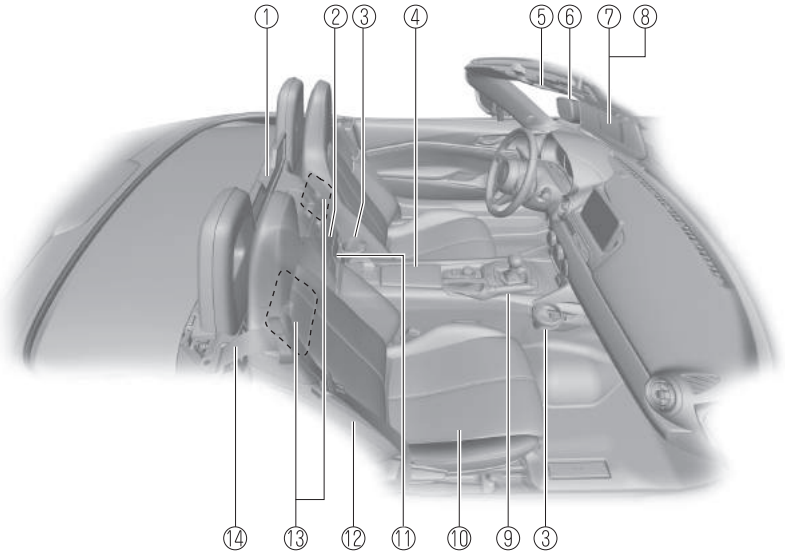

① Windblocker.....	page 5-140
② Seat side box.....	page 5-138
③ Cup holders.....	page 5-135
④ Console box.....	page 5-138
⑤ Interior light.....	page 5-132
⑥ Rearview mirror.....	page 3-29
⑦ Sunvisor.....	page 5-132
⑧ Vanity mirror.....	page 5-132
⑨ Parking brake.....	page 4-62
⑩ Seats.....	page 2-4
⑪ CD player.....	page 5-13
⑫ SRS air bag.....	page 2-24
⑬ Back trim storage boxes.....	page 5-139
⑭ Seat belt.....	page 2-7

Interior Overview

▼ Convertible Top (Retractable Fastback)

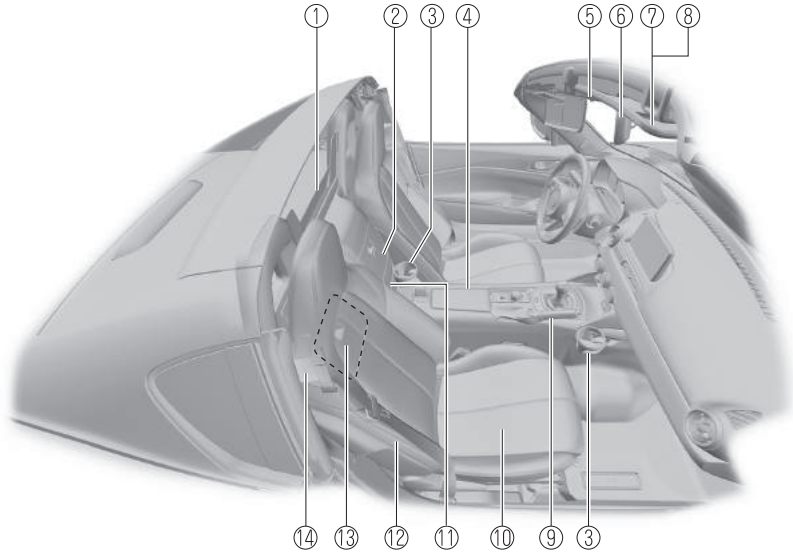

① Windblocker	page 5-140
② Seat side box	page 5-138
③ Cup holders	page 5-135
④ Console box.....	page 5-138
⑤ Interior light	page 5-132
⑥ Rearview mirror	page 3-29
⑦ Sunvisor	page 5-132
⑧ Vanity mirror	page 5-132
⑨ Parking brake	page 4-62
⑩ Seats	page 2-4
⑪ CD player	page 5-13
⑫ SRS air bag.....	page 2-24
⑬ Back trim storage box	page 5-139
⑭ Seat belt.....	page 2-7

Convertible Top (Soft Top)

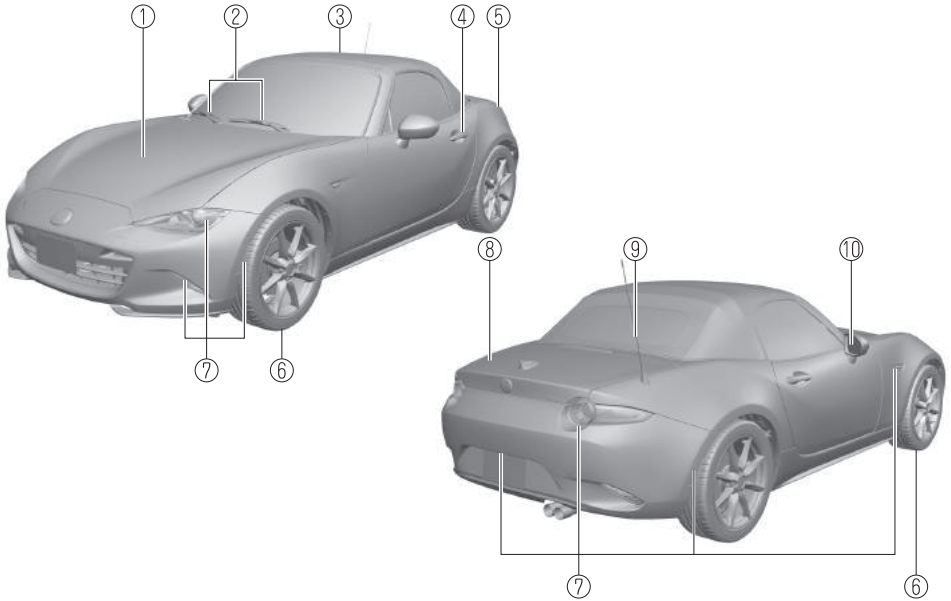

① Hood.....	page 6-24
② Windshield wiper blades.....	page 6-33
③ Convertible Top (Soft Top).....	page 3-34
④ Doors and keys.....	page 3-12
⑤ Fuel-filler lid.....	page 3-25
⑥ Wheels and Tires.....	page 6-41
⑦ Exterior lights.....	page 6-45
⑧ Trunk Lid.....	page 3-19
⑨ Antenna.....	page 5-13
⑩ Outside mirror.....	page 3-28

Exterior Overview

Convertible Top (Retractable Fastback)

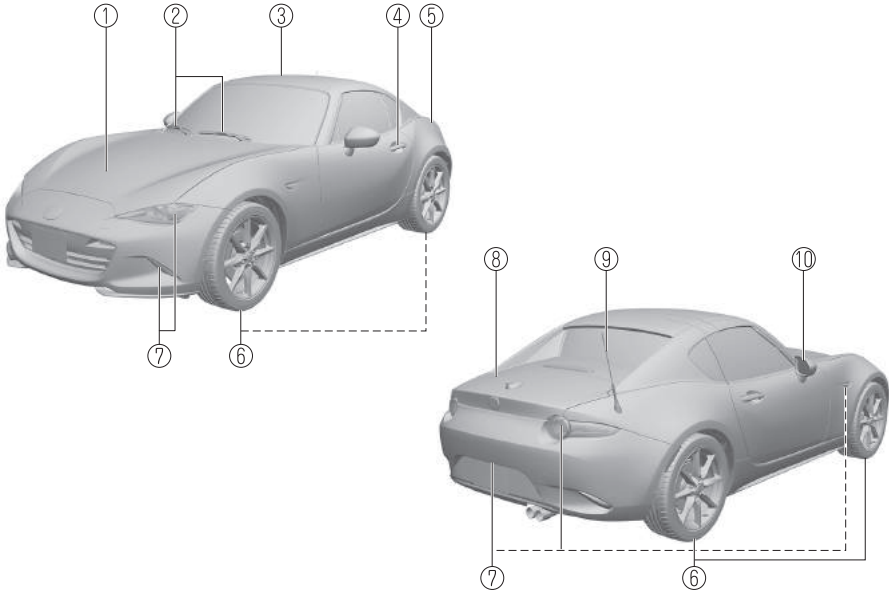

① Hood.....	page 6-24
② Windshield wiper blades.....	page 6-33
③ Convertible Top (Retractable Fastback).....	page 3-39
④ Doors and keys.....	page 3-12
⑤ Fuel-filler lid.....	page 3-25
⑥ Wheels and Tires.....	page 6-41
⑦ Exterior lights.....	page 6-45
⑧ Trunk Lid.....	page 3-19
⑨ Antenna.....	page 5-13
⑩ Outside mirror.....	page 3-28

2

Essential Safety Equipment

Important information about safety equipment, including seats, seat belt system, child-restraint systems and SRS air bags.

Seats	2-2
Seat Precautions	2-2
Seat.....	2-4
Head Restraints	2-6
Seat Belt Systems	2-7
Seat Belt Precautions	2-7
Seat Belt.....	2-10
Seat Belt Warning Systems	2-11
Seat Belt Pretensioner and Load Limiting Systems.....	2-12
Seat Belt Extender.....	2-13
Child Restraint	2-15
Child-Restraint Precautions	2-15
Child-Restraint System Installation	2-20
Installing Child-Restraint Systems	2-21
SRS Air Bags	2-24
Supplemental Restraint System (SRS) Precautions	2-24
Supplemental Restraint System Components	2-29
How the SRS Air Bags Work	2-31
SRS Air Bag Deployment Criteria.....	2-34
Limitations to SRS Air Bag	2-35
Passenger Occupant Classification System*.....	2-37
Constant Monitoring	2-42

Seat Precautions

WARNING

Make sure the adjustable components of a seat are locked in place:

Adjustable seats and seatbacks that are not securely locked are dangerous. In a sudden stop or collision, the seat or seatback could move, causing injury. Make sure the adjustable components of the seat are locked in place by attempting to slide the seat forward and backward and rocking the seatback.

Never allow children to adjust a seat:

Allowing children to adjust a seat is dangerous as it could result in serious injury if a child's hands or feet become caught in the seat.

Do not drive with the seatback unlocked:

All of the seatbacks play an important role in your protection in a vehicle. Leaving the seatback unlocked is dangerous as it can allow passengers to be ejected or thrown around and baggage to strike occupants in a sudden stop or collision, resulting in severe injury. After adjusting the seatback at any time, even when there are no other passengers, rock the seatback to make sure it is locked in place.

Adjust the driver's seat only when the vehicle is stopped:

Adjusting the driver's seat while the vehicle is moving is dangerous. The driver could lose control of the vehicle and have an accident.

Do not modify or replace the seats:

Modifying or replacing the seats such as replacing the upholstery or loosening any bolts is dangerous. The seats contain air bag components essential to the supplemental restraint system. Such modifications could damage the supplemental restraint system and result in serious injury. Consult an Authorized Mazda Dealer if there is any need to remove or reinstall the seats.

Do not drive with damaged seats:

Driving with damaged seats, such as seat cushions torn or damaged down to the urethane, is dangerous. A collision, even one not strong enough to inflate the air bags, could damage the seats which contain essential air bag components. If there was a subsequent collision, an air bag may not deploy which could lead to injuries. Always have an Authorized Mazda Dealer inspect the seats, seat belt pretensioners and air bags after a collision.

Do not drive with either seats reclined:

Sitting in a reclined position while the vehicle is moving is dangerous because you do not get the full protection from seat belts. During sudden braking or a collision, you can slide under the lap belt and suffer serious internal injuries. For maximum protection, sit well back and upright.

Do not place an object such as a cushion between the seatback and your back:

Putting an object such as a cushion between the seatback and your back is dangerous because you will be unable to maintain a safe driving posture and the seat belt cannot function at its full capacity in a collision, which could result in a serious accident, injury or death.

Do not place objects under the seat:

The object could get stuck and cause the seat to not be fixed securely, and result in an accident.

Do not stack cargo higher than the seatbacks:

Stacking luggage or other cargo higher than the seatbacks is dangerous. During sudden braking or a collision, objects can fly around and become projectiles that may hit and injure passengers.

Make sure luggage and cargo is secured before driving:

Not securing cargo while driving is dangerous as it could move or be crushed during sudden braking or a collision and cause injury.

Always leave your car locked and keep the car keys safely away from children:

Leaving your car unlocked or the keys in reach of children is dangerous. Children who find their way into the trunk through an open trunk can become accidentally locked in the trunk. This could result in death or brain damage from heat prostration, particularly in the summer. Always lock the doors and the trunk.



- *When operating a seat, be careful not to put your hands or fingers near the moving parts of the seat or on the side trim to prevent injury.*
- *When moving the seats, make sure there is no cargo in the surrounding area. If the cargo gets caught it could damage the cargo.*
- *When moving the seats forward and rearward or returning a rear-reclined seatback to its upright position, make sure you hold onto the seatback with your hand while operating. If the seatback is not held, the seat will move suddenly and could cause injury.*

Seat

▼ Seat Operation

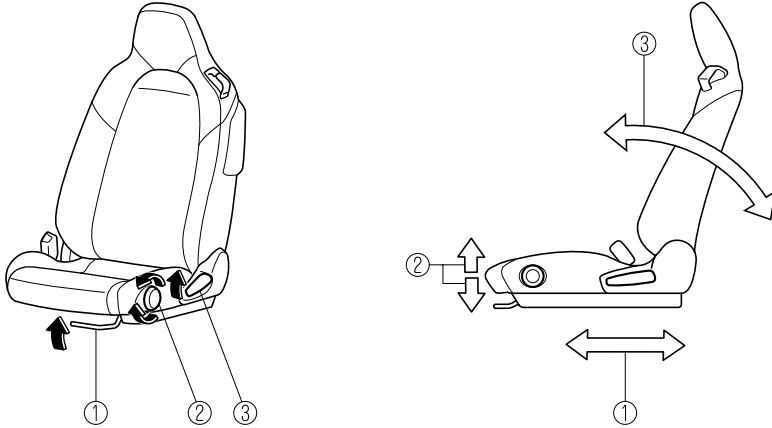

① Seat Slide

To move a seat forward or backward, raise the lever and slide the seat to the desired position and release the lever.

Make sure the lever returns to its original position and the seat is locked in place by attempting to push it forward and backward.

② Height Adjustment for Front Edge of Seat Bottom (Driver's Seat)

To adjust the height for front edge of the seat bottom, rotate the dial to the desired position.

③ Seat Recline

To change the seatback angle, lean forward slightly while raising the lever. Then lean back to the desired position and release the lever.

Make sure the lever returns to its original position and the seatback is locked in place by attempting to push it forward and backward.

▼ **Seat Warmer***

The seats are electrically heated. The ignition must be switched ON. Press the seat warmer switch while the ignition is switched ON to operate the seat warmer. The indicator lights turn on to indicate that the seat warmer is operating. The mode changes as follows each time the seat warmer switch is pressed.

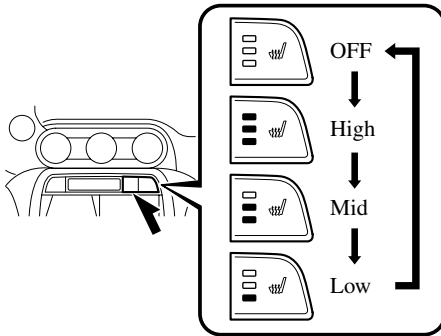

! WARNING

Be careful when using the seat warmer:

The heat from the seat warmer may be too hot for some people, as indicated as follows, and could cause a low-temperature burn.

- Infants, small children, elderly people, and physically challenged people
- People with delicate skin
- People who are excessively fatigued
- People who are intoxicated
- People who have taken sleep-inducing medicine such as sleeping pills or cold medicine

Do not use the seat warmer with anything having high moisture-retention ability such as a blanket or cushion on the seat:

The seat may be heated excessively and cause a low-temperature burn.

Do not use the seat warmer even when taking a short nap in the vehicle:

The seat may be heated excessively and cause a low-temperature burn.

Do not place heavy objects with sharp projections on the seat, or insert needles or pins into it:

This could cause the seat to become excessively heated and result in injury from a minor burn.

! CAUTION

Do not use organic solvents to clean the seat. It may damage the seat surface and the heater.

NOTE

- If the ignition is switched off while the seat warmer is operating (High, Mid or Low) and then switched ON again, the seat warmer will automatically operate at the temperature set before switching off the ignition.
- Use the seat warmer when the engine is running. Leaving the seat warmer on for long periods with the engine not running could cause the battery power to be depleted.
- The temperature of the seat warmer cannot be adjusted beyond High, Mid and Low because the seat warmer is controlled by a thermostat.

Seats

Head Restraints

▼ Non-Adjustable Head Restraints

Your vehicle is equipped with non-adjustable head restraints on the driver's and passenger's seatbacks. The non-adjustable head restraints consist of a trimmed foam covering over the upper structure of the seatbacks and are intended to help protect you and the passenger from neck injury. Adjust the seatbacks to their upright, on-road positions so that the head restraint is positioned as close as possible to the back of your head.

WARNING

Make sure the seatbacks are properly adjusted to their upright, on-road positions before the vehicle is driven:

Driving with the seatbacks not adjusted properly is dangerous. With no support behind your head, your neck could be seriously injured in a collision.

Seat Belt Precautions

Seat belts help to decrease the possibility of severe injury during accidents and sudden stops. Mazda recommends that the driver and passengers always wear seat belts.

(Except Mexico)

All of the seat belt retractors are designed to keep the lap/shoulder belts out of the way when not in use.

The driver's seat belt has no provisions for child-restraint systems and has only an emergency locking mode. The driver may wear it comfortably, and it will lock during a collision.

However, the passenger's seat lap/shoulder belt retractor operates in two modes: emergency locking mode, and for child-restraint systems, automatic locking mode. If you must use the passenger seat for a child, slide the passenger seat as far back as possible and make sure any child-restraint system is secured properly.

(Mexico)

All the seats have lap/shoulder belts. These belts have retractors with inertia locks that keep them out of the way when not in use. The locks allow the belts to remain comfortable on users, but they will lock in position during a collision.

WARNING

Always wear your seat belt and make sure all occupants are properly restrained:

Not wearing a seat belt is extremely dangerous. During a collision, occupants not wearing seat belts could hit someone or things inside the vehicle or even be thrown out of the vehicle. They could be seriously injured or even killed. In the same collision, occupants wearing seat belts would be much safer.

Do not wear twisted seat belts:

Twisted seat belts are dangerous. In a collision, the full width of the belt is not available to absorb the impact. This puts more force on the bones beneath the belt, which could cause serious injury or death. So, if your seat belt is twisted, you must straighten the seat belt to remove any twists and to allow the full width of the belt to be used.

Never use one seat belt on more than one person at a time:

Using one seat belt for more than one person at a time is dangerous. A seat belt used in this way cannot spread the impact forces properly and the two passengers could be crushed together and seriously injured or even killed. Never use one belt for more than one person at a time and always operate the vehicle with each occupant properly restrained.

Seat Belt Systems

Do not operate a vehicle with a damaged seat belt:

Using a damaged seat belt is dangerous. An accident could damage the belt webbing of the seat belt in use. A damaged seat belt cannot provide adequate protection in a collision. Have an Authorized Mazda Dealer inspect all seat belt systems in use during an accident before they are used again.

Have your seat belts changed immediately if the pretensioner or load limiter has been expended:

Always have an Authorized Mazda Dealer immediately inspect the seat belt pretensioners and air bags after any collision. Like the air bags, the seat belt pretensioners and load limiters will only function once and must be replaced after any collision that caused them to deploy. A seat belt with an expended pretensioner or load limiter is still better than wearing no seat belt at all; however, if the seat belt pretensioners and load limiters are not replaced, the risk of injury in a collision will increase.

Positioning the Shoulder Portion of the Seat Belt:

Improper positioning of the shoulder portion of the seat belt is dangerous. Always make sure the shoulder portion of the seat belt is positioned across your shoulder and near your neck, but never under your arm, on your neck, or on your upper arm.

Positioning the Lap Portion of the Seat Belt:

The lap portion of the seat belt worn too high is dangerous. In a collision, this would concentrate the impact force directly on the abdominal area, causing serious injury. Wear the lap portion of the belt snugly and as low as possible.



Belt retraction may become difficult if the belts and seat belt guides are soiled, so try to keep them clean. For more details about cleaning the seat belts, refer to "Seat Belt Maintenance" (page 6-68).

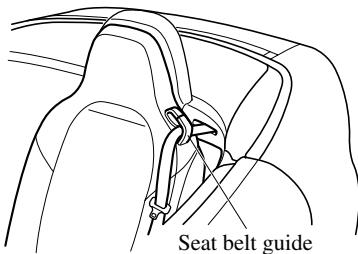

▼ Pregnant Women and Persons with Serious Medical Conditions

Pregnant women should always wear seat belts. Ask your doctor for specific recommendations.

The lap belt should be worn **SNUGLY AND AS LOW AS POSSIBLE OVER THE HIPS**.

The shoulder belt should be worn across your shoulder properly, but never across the stomach area.

Persons with serious medical conditions also should wear seat belts. Check with your doctor for any special instructions regarding specific medical conditions.



▼ Emergency Locking Mode

When the seat belt is fastened, it will always be in the emergency locking mode.

In the emergency locking mode, the belt remains comfortable on the occupant and the retractor will lock in position during a collision.

If the belt is locked and cannot be pulled out, retract the belt once, and then try pulling it out slowly. If this fails, pull the belt strongly one time and loosen, then pull it out again slowly.

(Seat Belt with Automatic Locking Mode)

When the seat belt is fastened, it will always be in the emergency locking mode until it is switched to automatic locking mode by pulling it all the way out to its full length. If the belt feels tight and hinders comfortable movement while the vehicle is stopped or in motion, it may be in the automatic locking mode because the belt has been pulled too far out. To return the belt to the more comfortable emergency locking mode, wait until the vehicle has stopped in a safe, level area, retract the belt fully to convert it back to emergency locking mode and then extend it around you again.

▼ Automatic Locking Mode*

Always use the automatic locking mode to keep the child-restraint system from shifting to an unsafe position in the event of an accident. To enable seat belt automatic locking mode, pull it all the way out and connect it as instructed on the child-restraint system. It will retract down to the child-restraint system and stay locked on it. See the section on child restraint (page 2-15).

Seat Belt Systems

Seat Belt

⚠ WARNING

Always wear the seat belt with it correctly routed in its guide:

Wearing a seat belt without the seat belt routed in its guide is dangerous because the seat belt would not be able to provide adequate protection in an accident, which could result in serious injury.

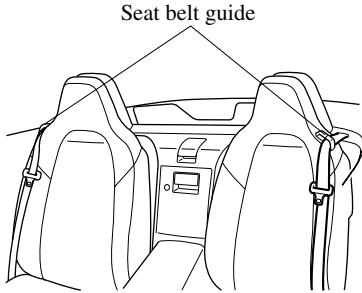

▼ Fastening the Seat Belt

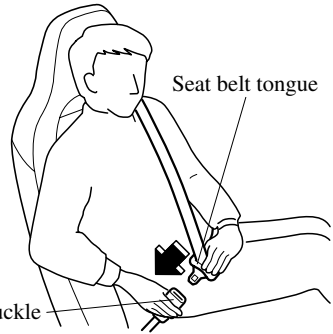

Position the lap belt as low as possible, not on the abdominal area, then adjust the shoulder belt so that it fits snugly against your body.

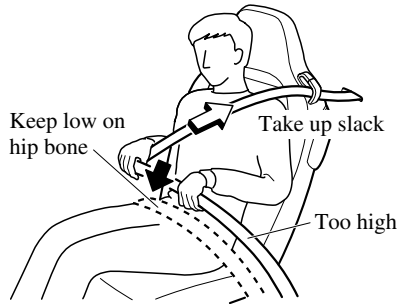

▼ Unfastening the Seat Belt

Depress the button on the seat belt buckle. If the belt does not fully retract, pull it out and check for kinks or twists. Then make sure it remains untwisted as it retracts.

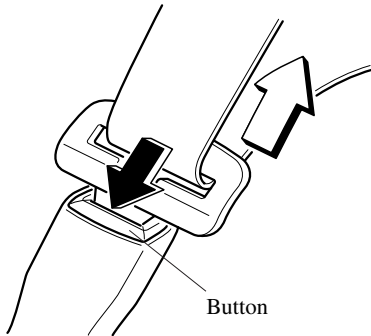
**NOTE**

If a belt does not fully retract, inspect it for kinks and twists. If it is still not retracting properly, have it inspected at an Authorized Mazda Dealer.

Seat Belt Warning Systems

If it detects that the occupant seat belt is unfastened, the warning light or beep alerts the occupant.

Refer to Warning/Indicator Lights on page 4-26.

Refer to Seat Belt Warning Beep on page 7-49.

Seat Belt Systems

Seat Belt Pretensioner and Load Limiting Systems

For optimum protection, the driver and passenger seat belts are equipped with pretensioner and load limiting systems. For both these systems to work properly you must wear the seat belt properly.

Pretensioners:

When a collision is detected, the pretensioners deploy simultaneously with the air bags.

For deployment details, refer to the SRS Air Bag Deployment Criteria (page 2-34).

The seat belt retractors remove slack quickly as the air bags are expanding. Any time the air bags and seat belt pretensioners have fired they must be replaced.

A system malfunction or operation conditions are indicated by a warning. Refer to Warning/Indicator Lights on page 4-26.

Refer to Air Bag/Seat Belt Pretensioner System Warning Beep on page 7-48.

(With Passenger Occupant Classification System)

In addition, the pretensioner system for the passenger, like the front and side passenger air bag, is designed to only deploy when the passenger occupant classification sensor detects a passenger sitting on the passenger's seat.

For details, refer to the passenger occupant classification sensor (page 2-37).

Load limiter:

The load limiting system releases belt webbing in a controlled manner to reduce belt force on the occupant's chest. While the most severe load on a seat belt occurs in frontal collisions, the load limiter has an automatic mechanical function and can activate in any accident mode with sufficient occupant movement.

Even if the pretensioners have not fired, the load limiting function must be checked by an Authorized Mazda Dealer.



Wear seat belts only as recommended in this owner's manual:

Incorrect positioning of the driver and passenger seat belts is dangerous. Without proper positioning, the pretensioner and load limiting systems cannot provide adequate protection in an accident and this could result in serious injury. For more details about wearing seat belts, refer to "Fastening the seat belts" (page 2-10).

Have your seat belts changed immediately if the pretensioner or load limiter has been expended:

Always have an Authorized Mazda Dealer immediately inspect the seat belt pretensioners and air bags after any collision. Like the air bags, the seat belt pretensioners and load limiters will only function once and must be replaced after any collision that caused them to deploy. A seat belt with an expended pretensioner or load limiter is still better than wearing no seat belt at all; however, if the seat belt pretensioners and load limiters are not replaced, the risk of injury in a collision will increase.

Do not modify the components or wiring, or use electronic testing devices on the pretensioner system:

Modifying the components or wiring of the pretensioner system, including the use of electronic testing devices is dangerous. You could accidentally activate it or make it inoperable which would prevent it from activating in an accident. The occupants or repairers could be seriously injured.

Properly dispose of the pretensioner system:

Improper disposal of the pretensioner system or a vehicle with non-deactivated pretensioners is dangerous. Unless all safety procedures are followed, injury could result. Have an Authorized Mazda Dealer safely dispose of the pretensioner system or scrap a pretensioner system equipped vehicle.

NOTE

- *The pretensioner system may not operate depending on the type of the collision. For details, refer to the SRS Air Bag Deployment Criteria (page 2-34).*
- *Some smoke (non-toxic gas) will be released when the air bags and pretensioners deploy. This does not indicate a fire. This gas normally has no effect on occupants, however, those with sensitive skin may experience light skin irritation. If residue from the deployment of the air bags or the pretensioner system gets on the skin or in the eyes, wash it off as soon as possible.*

Seat Belt Extender

If your seat belt is not long enough, even when fully extended, a seat belt extender may be available to you at no charge from your Authorized Mazda Dealer.

This extender will be only for you and for the particular vehicle and seat. Even if it plugs into other seat belts, it may not hold in the critical moment of a crash.

When ordering an extender, only order one that provides the necessary additional length to fasten the seat belt properly.

Please contact your Authorized Mazda Dealer for more information.

WARNING

Do not use a seat belt extender unless it is necessary:

Using a seat belt extender when not necessary is dangerous. The seat belt will be too long and not fit properly. In an accident, the seat belt will not provide adequate protection and you could be seriously injured. Only use the extender when it is required to fasten the seat belt properly.

Seat Belt Systems

Do not use an improper extender:

Using a seat belt extender that is for another person or a different vehicle or seat is dangerous. The seat belt will not provide adequate protection and the user could be seriously injured in an accident. Only use the extender provided for you and for the particular vehicle and seat. NEVER use the extender in a different vehicle or seat. If you sell your Mazda, do not leave your seat belt extender in the vehicle. It could be used accidentally by the new owner of the vehicle. After removing the seat belt extender, discard it. Never use the seat belt extender in any other vehicle you may own in the future.

Do not use an extender that is too long:

Using an extender that is too long is dangerous. The seat belt will not fit properly. In an accident, the seat belt will not provide adequate protection and you could be seriously injured. Do not use the extender or choose one shorter in length if the distance between the extender's buckle and the center of the user's body is less than 15 cm (6 in).

Do not leave a seat belt extender connected to the buckle:

Leaving a seat belt extender connected to the buckle without using the seat belt is dangerous. When the seat belt extender is connected to the driver's seat belt buckle (or passenger's seat belt buckle), the SRS driver's (or passenger's) air bag system will determine that the driver (or passenger) is wearing the seat belt even if the driver (or passenger) is not wearing it. This condition could cause the driver's (or passenger's) air bag to not activate correctly and result in death or serious injury in the event of collision. Always wear the seat belt with the seat belt extender.

Do not use the seat belt extender when installing a child-restraint system on the passenger seat:

Using a seat belt extender to fasten a child-restraint system on any seat is dangerous. Always follow the child-restraint system manufacturer's installation instructions and never use a seat belt extender.

NOTE

When not in use, remove the seat belt extender and store it in the vehicle. If the seat belt extender is left connected, the seat belt extender might get damaged as it will not retract with the rest of the seat belt and can easily fall out of the door when not in use and be damaged. In addition, the seat belt warning light will not illuminate and function properly.

Child-Restraint Precautions

Mazda strongly urges the use of child-restraint systems for children small enough to use them.

You are required by law to use a child-restraint system for children in the U.S. and Canada. Check your local and state or provincial laws for specific requirements regarding the safety of children riding in your vehicle.

Whatever child-restraint system you consider, please pick the appropriate one for the age and size of the child, obey the law and follow the instructions that come with the individual child-restraint system.

A child who has outgrown child-restraint systems should use seat belts, both lap and shoulder. If the shoulder belt crosses the neck or face, move the child closer to the center of the vehicle.

A rear-facing child-restraint system should **NEVER** be used on the passenger seat with the air bag system activated.

(With Passenger Occupant Classification System)

To reduce the chance of injuries caused by deployment of the passenger air bag, the passenger occupant classification sensor work as a part of the supplemental restraint system. This system deactivates the passenger front and side air bags and also the passenger seat belt pretensioner system when the passenger air bag deactivation indicator light illuminates.

When an infant or small child sits on the passenger seat, the system shuts off the passenger front and side air bags and seat belt pretensioner system, so make sure the passenger air bag deactivation indicator light illuminates.

For more details, refer to "Passenger occupant classification sensor" (page 2-37).

Child Restraint

! WARNING

Use the correct size child-restraint system:

For effective protection in vehicle accidents and sudden stops, a child must be properly restrained using a seat belt or child-restraint system depending on age and size. If not, the child could be seriously injured or even killed in an accident.

Follow the manufacturer's instructions and always keep the child-restraint system buckled down:

An unsecured child-restraint system is dangerous. In a sudden stop or a collision it could move causing serious injury or death to the child or other occupants. Make sure any child-restraint system is properly secured in place according to the child-restraint system manufacturer's instructions. When not in use, remove it from the vehicle or fasten it with a seat belt.

Always secure a child in a proper child-restraint system:

Holding a child in your arms while the vehicle is moving is extremely dangerous. No matter how strong the person may be, he or she cannot hold onto a child in a sudden stop or collision and it could result in serious injury or death to the child or other occupants. Even in a moderate accident, the child may be exposed to air bag forces that could result in serious injury or death to the child, or the child may be slammed into an adult, causing injury to both child and adult.

Always make sure the passenger air bag deactivation indicator light is illuminated when using a child-restraint system:

Seating a child in a child-restraint system that is installed on the passenger seat with the passenger air bag deactivation indicator light not illuminated is extremely dangerous. In an accident, an air bag could inflate and cause serious injuries or even death to the child seated in the child-restraint system. Always make sure the passenger air bag deactivation indicator light is illuminated.

Refer to Passenger Occupant Classification System on page 2-37.

(Except Mexico)

Vehicles with a passenger air bag have the following warning label. The warning label is displayed in compliance with regulations.



(Mexico)

NEVER use a rearward facing child restraint on a seat protected by an ACTIVE AIRBAG in front of it, DEATH or SERIOUS INJURY to the CHILD can occur.

Vehicles with a passenger air bag have the following warning label. The warning label reminds you not to put a rear-facing child-restraint system on the passenger seat at any time.

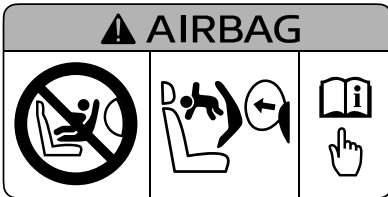

Before installing child-restraint system on the passenger seat, move the passenger seat as far back as possible:

In a collision, the force of a deploying air bag could cause serious injury or death to the child.



Child Restraint

Seating a child in a child-restraint system on the passenger seat is dangerous under certain conditions (With Passenger Occupant Classification System):

Your vehicle is equipped with passenger occupant classification sensor. Even with the passenger occupant classification sensor, if you must use the passenger seat to seat a child, using a child-restraint system on the passenger seat under the following conditions increases the danger of the passenger air bag deploying and could result in serious injury or death to the child.

- The passenger air bag deactivation indicator light does not illuminate when seating a child in the child-restraint system.
- Luggage or other items are placed on the seat with the child in the child-restraint system.
- The seat is washed.
- Liquids are spilled on the seat.
- The passenger seat is moved backward, pushing into luggage or other items placed behind it.
- Luggage or other items are placed between the passenger seat and driver seat.
- An electric device is put on the passenger's seat.
- An additional electrical device, such as a seat warmer is installed to the surface of the passenger seat.

Do not allow a child or anyone to lean over or against the side window of a vehicle with side air bags:

It is dangerous to allow anyone to lean over or against the side window, the area of the passenger seat from which the side air bags deploy, even if a child-restraint system is used. The impact of inflation from a side air bag could cause serious injury or death to an out of position child. Furthermore, leaning over or against the door could block the side air bags and eliminate the advantages of supplemental protection. Because the side air bag deploys from the outboard shoulder of the seat, do not allow the child to lean over or against the side window, even if the child is seated in a child-restraint system.

Never use one seat belt on more than one person at a time:

Using one seat belt for more than one person at a time is dangerous. A seat belt used in this way cannot spread the impact forces properly and the two passengers could be crushed together and seriously injured or even killed. Never use one belt for more than one person at a time and always operate the vehicle with each occupant properly restrained.

Always use a child-restraint system designed for use without a tether or the LATCH lower anchor:

Using a child-restraint system that requires a tether or the LATCH lower anchor is dangerous. Your Mazda does not have a child-restraint tether or the LATCH lower anchor. The child-restraint system cannot be properly secured. In a collision, it could move and injure other occupants as well as result in serious injuries or death to the child.

 **CAUTION**

A seat belt or child-restraint system can become very hot in a closed vehicle during warm weather. To avoid burning yourself or a child, check them before you or your child touches them.

Child Restraint

Child-Restraint System Installation

▼ Child-Restraint System Types

In this owner's manual, explanation of child-restraint systems is provided for the following three types of popular child-restraint systems: infant seat, child seat, booster seat.

NOTE

- *Installation position is determined by the type of child-restraint system. Always read the manufacturer's instructions and this owner's manual carefully.*
- *Due to variations in the design of child-restraint systems, vehicle seats and seat belts, all child-restraint systems may not fit all seating positions. Before purchasing a child-restraint system, it should be tested in the specific vehicle seating position (or positions) where it is intended to be used. If a previously purchased child-restraint system does not fit, you may need to purchase a different one that will.*

Infant seat

An infant seat provides restraint by bracing the infant's head, neck and back against the seating surface.

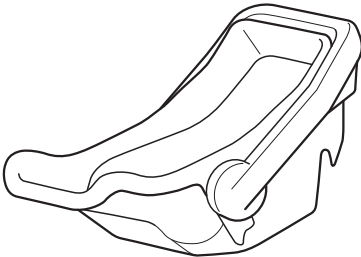

Child seat

A child seat restrains a child's body using the harness.



Booster seat

A booster seat is a child restraint accessory designed to improve the fit of the seat belt system around the child's body.

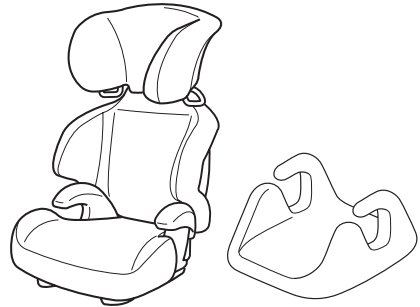

Installing Child-Restraint Systems

The passenger lap/shoulder belt can easily be converted into the automatic locking mode, which must be done to hold the child-restraint system.

NOTE

- *To check if your seats have side air bags:*
Mazda vehicles equipped with side air bag will have an embossed "SRS AIRBAG" marking on the outboard shoulder of the seats.
- *Follow the child-restraint system manufacturer's instructions carefully. Depending on the type of child-restraint system, it may not employ seat belts which are in automatic locking mode, however if it uses an upper tether, it may not be mounted properly in this vehicle as there is no safe way to anchor the tether. Confirm whether the child-restraint system can be used with seat belts by reading the child-restraint system manufacturer's instructions.*

WARNING

Do not allow a child or anyone to lean over or against the side window of a vehicle with side air bags:

It is dangerous to allow anyone to lean over or against the side window, the area of the passenger seat from which the side air bags deploy, even if a child-restraint system is used. The impact of inflation from a side air bag could cause serious injury or death to an out of position child. Furthermore, leaning over or against the door could block the side air bags and eliminate the advantages of supplemental protection. Because the side air bag deploys from the outboard shoulder of the seat, do not allow the child to lean over or against the side window, even if the child is seated in a child-restraint system.

CAUTION

When moving the seats forward and rearward, make sure you hold onto the seatback with your hand while operating. If the seatback is not held, the seat will move suddenly and could cause injury.

Child Restraint

Passenger's Seat Child-Restraint System Installation (With Passenger Occupant Classification System)

1. Make sure the ignition is switched off.
2. Slide the seat as far back as possible.



3. Place the child-restraint system on the seat without putting your weight on the seat and secure the child-restraint system with the lap portion of the lap/shoulder belt. See the manufacturer's instructions on the child-restraint system for belt routing instructions.
4. To get the retractor into the automatic locking mode, pull the shoulder belt portion of the seat belt until the entire length of the belt is out of the retractor.
5. Push the child-restraint system firmly into the vehicle seat. Be sure the belt retracts as snugly as possible. A clicking noise from the retractor will be heard during retraction if the system is in automatic locking mode. If the belt does not lock the seat down tight, repeat the previous step and also this one.

NOTE

Inspect this function before each use of the child-restraint system. You should not be able to pull the shoulder belt out of the retractor while the system is in the automatic locking mode. When you remove the child-restraint system, be sure the belt fully retracts to return the system to emergency locking mode before occupants use the seat belts.

6. Seat your child safely in the child-restraint system and secure the child according to the instructions from the child-restraint system manufacturer.
7. Switch the ignition ON and make sure the passenger air bag deactivation indicator light illuminates after installing a child-restraint system on the passenger seat.

If the passenger air bag deactivation indicator light does not illuminate, remove the child-restraint system, switch the ignition to OFF, and then re-install the child-restraint system (page 2-37).

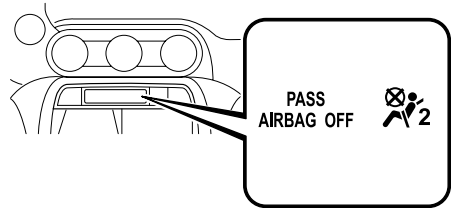

 **WARNING**

Do not seat a child in a child-restraint system on the passenger seat if the passenger air bag deactivation indicator light does not illuminate (With Passenger Occupant Classification System):

Seating a child in a child-restraint system installed on the passenger seat with the passenger air bag deactivation indicator light not illuminated is dangerous. If this indicator light does not illuminate, this means that the passenger front and side air bags, and seat belt pretensioner are ready for deployment. If an accident were to deploy an air bag, a child in a child-restraint system sitting in the passenger seat could be seriously injured or killed. If the indicator light does not illuminate after seating a child in a child-restraint system on the passenger seat consult an Authorized Mazda Dealer as soon as possible.

Supplemental Restraint System (SRS) Precautions

The front and side supplemental restraint systems (SRS) include different types of air bags. **Please verify which kinds of air bags are equipped on your vehicle by locating the “SRS AIRBAG” location indicators.** These indicators are visible in the area where the air bags are installed.

The air bags are installed in the following locations:

- The steering wheel hub (driver air bag)
- The passenger dashboard (passenger air bag)
- The outboard sides of the seatbacks (side air bags)

The air bag supplemental restraint systems are designed to provide supplemental protection in certain situations so seat belts are always important in the following ways:

Without seat belt usage, the air bags cannot provide adequate protection during an accident. Seat belt usage is necessary to:

- Keep the occupant from being thrown into an inflating air bag.
- Reduce the possibility of injuries during an accident that is not designed for air bag inflation, such as roll-over or rear impact.
- Reduce the possibility of injuries in frontal, near frontal or side collisions that are not severe enough to activate the air bags.
- Reduce the possibility of being thrown from your vehicle.
- Reduce the possibility of injuries to lower body and legs during an accident because the air bags provide no protection to these parts of the body.
- Hold the driver in a position which allows better control of the vehicle.

If your vehicle is also equipped with a passenger occupant classification system, refer to the Passenger Occupant Classification System (page 2-37) for details.

If your vehicle is equipped with a passenger occupant classification system, the passenger air bag deactivation indicator light illuminates for a specified time after the ignition is switched ON.

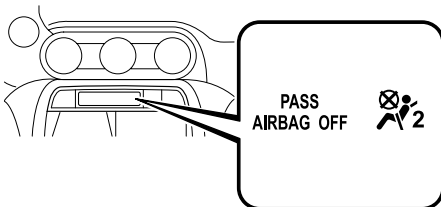

Small children must be protected by a child-restraint system as stipulated by law in every state and province. In certain states and provinces, larger children must use a child-restraint system (page 2-15).

Carefully consider which child-restraint system is necessary for your child and follow the installation directions in this Owner's Manual as well as the child-restraint system manufacturer's instructions.

Do not use a child-restraint system which employs an upper tether because there is no appropriate means to anchor the tether.

 **WARNING**

Seat belts must be worn in air bag equipped vehicles:

Depending only on the air bags for protection during an accident is dangerous. Alone, air bags may not prevent serious injuries. The appropriate air bags can be expected to inflate only in the first accident, such as frontal, near frontal or side collisions that are at least moderate. Vehicle occupants should always wear seat belts.

Always make sure the passenger air bag deactivation indicator light is illuminated when using a child-restraint system (With Passenger Occupant Classification System):

Seating a child in a child-restraint system that is installed on the passenger seat with the passenger air bag deactivation indicator light not illuminated is extremely dangerous. In an accident, an air bag could inflate and cause serious injuries or even death to the child seated in the child-restraint system. Always make sure the passenger air bag deactivation indicator light is illuminated.

Refer to Occupant Classification System on page 2-37.

Do not sit too close to the driver and passenger air bags:

Sitting too close to the driver and passenger air bag modules or placing hands or feet on them is extremely dangerous. The driver and passenger air bags inflate with great force and speed. Serious injuries could occur if someone is too close. The driver should always hold onto only the rim of the steering wheel. The passenger should keep both feet on the floor. Seat occupants should adjust their seats as far back as possible and always sit upright against the seatbacks with seat belts worn properly.

Do not sit too close to a door or lean against doors in vehicles with side air bags:

Sitting too close to the side air bag modules or placing hands on them is extremely dangerous. A side air bag inflates with great force and speed directly out of the outboard shoulder of the seat and expands along the door on the side the car is hit. Serious injury could occur if someone is sitting too close to the door or leaning against a window in the seats. Furthermore, sleeping up against the door or hanging out the driver-side window while driving could block the side air bag and eliminate the advantages of supplemental protection. Give the side air bags room to work by sitting in the center of the seat while the vehicle is moving with seat belts worn properly.

Sit in the center of the seat and wear seat belts properly:

Sitting too close to the side air bag modules or placing hands on them, or sleeping up against the door or hanging out the windows is extremely dangerous. The side air bags inflate with great force and speed directly expanding along the door on the side the car is hit. Serious injury could occur if someone is sitting too close to the door. Give the side air bags room to work by sitting in the center of the seat while the vehicle is moving with seat belts worn properly.

Do not attach objects on or around the area where driver and passenger air bags deploy:

Attaching an object to the driver and passenger air bag modules or placing something in front of them is dangerous. In an accident, an object could interfere with air bag inflation and injure the occupants.

Do not attach objects on or around the area where a side air bag deploys:

Attaching objects to the seat in such a way as to cover the outboard side of the seat in any way is dangerous. In an accident the object could interfere with the side air bag, which inflates from the outboard side of the seats, impeding the added protection of the side air bag system or redirecting the air bag in a way that is dangerous. Furthermore, the bag could be cut open releasing the gas.

Do not hang net bags, map pouches or backpacks with side straps on the seats. Never use seat covers on the seats. Always keep the side air bag modules in your seats free to deploy in the event of a side collision.

Do not touch the components of the supplemental restraint system after the air bags have inflated:

Touching the components of the supplemental restraint system after the air bags have inflated is dangerous. Immediately after inflation, they are very hot. You could get burned.

Never install any front-end equipment to your vehicle:

Installation of front-end equipment, such as frontal protection bar (kangaroo bar, bull bar, push bar, or other similar devices), snowplow, or winches, is dangerous. The air bag crash sensor system could be affected. This could cause air bags to inflate unexpectedly, or it could prevent the air bags from inflating during an accident. Occupants could be seriously injured.

Do not modify the suspension:

Modifying the vehicle suspension is dangerous. If the vehicle's height or the suspension is modified, the vehicle will be unable to accurately detect a collision resulting in incorrect or unexpected air bag deployment and the possibility of serious injuries.

Do not modify a door or leave any damage unrepaired. Always have an Authorized Mazda Dealer inspect a damaged door:

Modifying a door or leaving any damage unrepaired is dangerous. Each door has a side crash sensor as a component of the supplemental restraint system. If holes are drilled in a door, a door speaker is left removed, or a damaged door is left unrepaired, the sensor could be adversely affected causing it to not detect the pressure of an impact correctly during a side collision. If a sensor does not detect a side impact correctly, the side air bags and the seat belt pretensioner may not operate normally which could result in serious injury to occupants.

Do not modify the supplemental restraint system:

Modifying the components or wiring of the supplemental restraint system is dangerous. You could accidentally activate it or make it inoperable. Do not make any modifications to the supplemental restraint system. This includes installing trim, badges, or anything else over the air bag modules. It also includes installing extra electrical equipment on or near system components or wiring. An Authorized Mazda Dealer can provide the special care needed in the removal and installation of seats. It is important to protect the air bag wiring and connections to assure that the bags do not accidentally deploy, and that the passenger occupant classification system and the seats retain an undamaged air bag connection.

Do not place luggage or other objects under the seats:

Placing luggage or other objects under the seats is dangerous. The components essential to the supplemental restraint system could be damaged, and in the event of a side collision, the appropriate air bags may not deploy, which could result in death or serious injury. To prevent damage to the components essential to the supplemental restraint system, do not place luggage or other objects under the seats.

Do not operate a vehicle with damaged air bag/seat belt pretensioner system components:

Expended or damaged air bag/seat belt pretensioner system components must be replaced after any collision which caused them to deploy or damage them. Only a trained Authorized Mazda Dealer can fully evaluate these systems to see that they will work in any subsequent accident. Driving with an expended or damaged air bag or pretensioner unit will not afford you the necessary protection in the event of any subsequent accident which could result in serious injury or death.

Do not remove interior air bag parts:

Removing any components such as the seats, front dashboard, the steering wheel, containing air bag parts or sensors is dangerous. These parts contain essential air bag components. The air bag could accidentally activate and cause serious injuries. Always have an Authorized Mazda Dealer remove these parts.

Properly dispose of the air bag system:

Improper disposal of an air bag or a vehicle with live air bags in it can be extremely dangerous. Unless all safety procedures are followed, injury could result. Have an Authorized Mazda Dealer safely dispose of the air bag system or scrap an air bag equipped vehicle.

NOTE

- *If it becomes necessary to have the components or wiring system for the supplementary restraint system modified to accommodate a person with certain medical conditions in accordance with a certified physician, contact an Authorized Mazda Dealer, refer to “Customer Assistance (U.S.A.)” (page 8-2).*
- *When an air bag deploys, a loud inflation noise can be heard and some smoke will be released. Neither is likely to cause injury, however, the texture of the air bags may cause light skin injuries on body parts not covered with clothing through friction.*
- *Should you sell your Mazda, we urge you to tell the new owner of its air bag systems and that familiarization with all instructions about them, from the Owner’s Manual, is important.*
- *Vehicles with a passenger air bag have a warning label attached as shown in the following.*

(Except Mexico)

This warning label is displayed in compliance with regulations.



(Mexico)

This warning label reminds you not to put a rear-facing child-restraint system on the passenger seat at any time.



Supplemental Restraint System Components

(With Passenger Occupant Classification System)

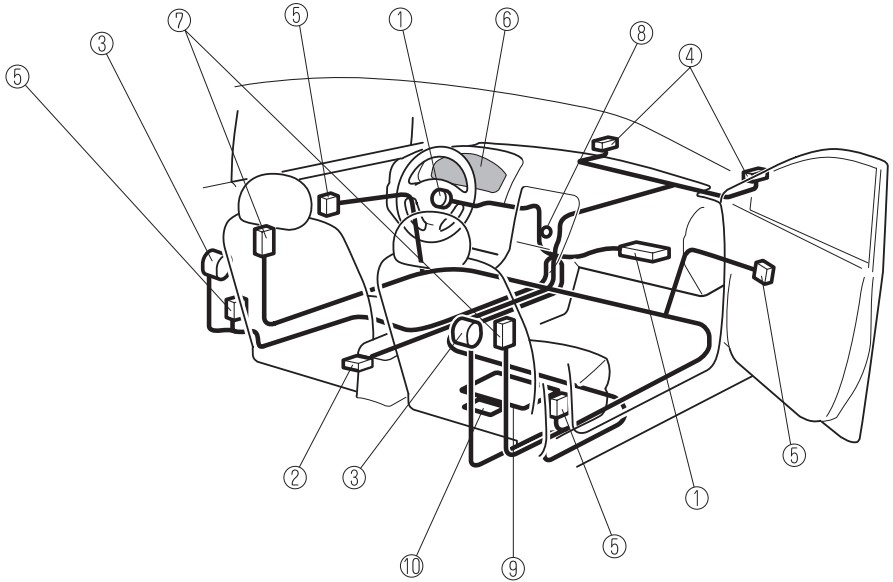

(Without Passenger Occupant Classification System)

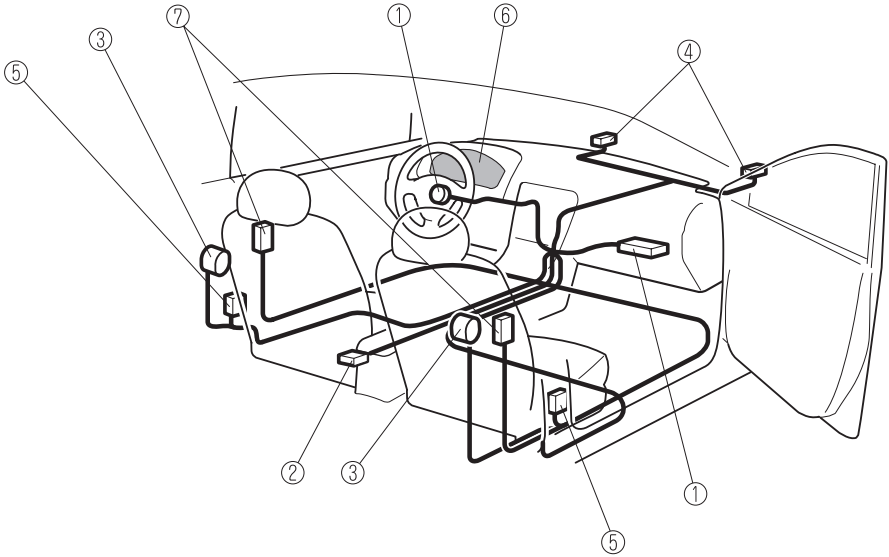

- ① Driver/Passenger inflators and air bags
- ② Crash sensors, and diagnostic module (SAS unit)
- ③ Seat belt pretensioners (page 2-12)
- ④ Front air bag sensors
- ⑤ Side crash sensors
- ⑥ Air bag/seat belt pretensioner system warning light (page 4-18)
- ⑦ Side inflators and air bags
- ⑧ Passenger air bag deactivation indicator light* (page 2-37)
- ⑨ Passenger occupant classification sensor* (page 2-37)
- ⑩ Passenger occupant classification module*

How the SRS Air Bags Work

Your Mazda is equipped with the following types of SRS air bags. SRS air bags are designed to work together with the seat belts to help to reduce injuries during an accident. The SRS air bags are designed to provide further protection for passengers in addition to the seat belt functions. Be sure to wear seat belts properly.

▼ Seat Belt Pretensioners

The seat belt pretensioners are designed to deploy in moderate or severe frontal, near frontal collisions.

In addition, during a side collision, the pretensioner operates on the side in which the collision occurs. The pretensioners operate differently depending on what types of air bags are equipped. For more details about seat belt pretensioner operation, refer to the SRS Air Bag Deployment Criteria (page 2-34).

▼ Driver Air Bag

The driver's air bag is mounted in the steering wheel.

When air bag crash sensors detect a frontal impact of greater than moderate force, the driver's air bag inflates quickly helping to reduce injury mainly to the driver's head or chest caused by directly hitting the steering wheel.

For more details about air bag deployment, refer to "SRS Air Bag Deployment Criteria" (page 2-34).

(With Passenger Occupant Classification System)

The driver's dual-stage air bag controls air bag inflation in two energy stages. During an impact of moderate severity, the driver's air bag deploys with lesser energy, whereas during more severe impacts, it deploys with more energy.

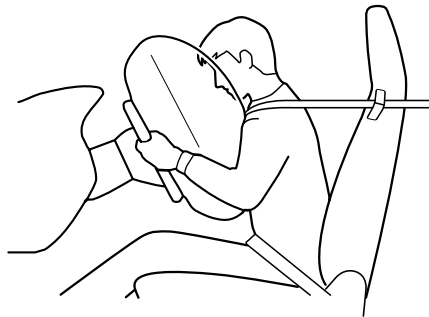

SRS Air Bags

▼ Passenger Air Bag

The passenger air bag is mounted in the passenger dashboard.

The inflation mechanism for the passenger air bag is the same as the driver's air bag.

For more details about air bag deployment, refer to "SRS Air Bag Deployment Criteria" (page 2-34).

(With Passenger Occupant Classification System)

In addition, the passenger air bag is designed to only deploy when the passenger occupant classification sensor detects a passenger sitting on the passenger's seat. For details, refer to the passenger occupant classification system (page 2-37).

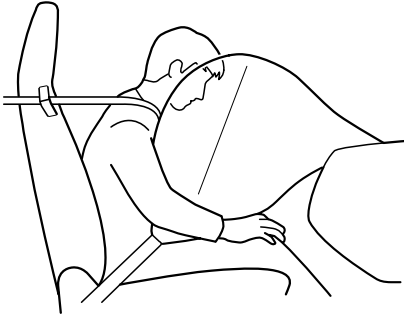

▼ Side Air Bags

The side air bags are mounted in the outboard sides of the seatbacks.

When the air bag crash sensors detect a side impact of greater than moderate force, the system inflates the side air bag only on the side in which the vehicle was hit. The side air bag inflates quickly to reduce injury to the driver or passenger's head and chest caused by directly hitting interior parts such as a door or window.

For more details about air bag deployment, refer to "SRS Air Bag Deployment Criteria" (page 2-34).

(With Passenger Occupant Classification System)

In addition, the passenger side bag is designed to only deploy when the passenger occupant classification sensor detects a passenger sitting on the passenger's seat. For details, refer to the passenger occupant classification system (page 2-37).

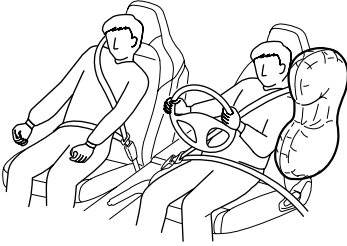



▼ Warning Light/Beep

A system malfunction or operation conditions are indicated by a warning. Refer to Warning/Indicator Lights on page 4-26. Refer to Warning Sound is Activated on page 7-48.

SRS Air Bag Deployment Criteria

This chart indicates the applicable SRS equipment that will deploy depending on the type of collision.

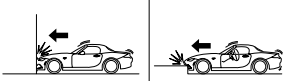
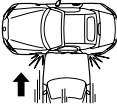
(The illustrations are the representative cases of collisions.)

	Types of collision		
	A severe frontal/near frontal collision	A severe side collision* ²	A rear collision
SRS equipment			
Seat belt pretensioner	X* ¹ (both sides)	X* ¹ (impact side only)	No air bag and seat belt pretensioner will be activated in a rear collision.
Driver air bag	X		
Passenger air bag	X* ¹		
Side air bag		X* ¹ (impact side only)	

X : The SRS air bag equipment is designed to deploy in a collision.

***1 (Passenger Occupant Classification System)**

The passenger front and side air bags and the seat belt pretensioner are designed to deploy when the passenger occupant classification sensor detects a passenger sitting on the passenger's seat.

*2 In a side collision, the seat belt pretensioners and the side air bags deploy (only on the side in which the collision occurs).

NOTE

In a frontal offset collision, the equipped air bags and pretensioners may all deploy depending on the direction, angle, and rate of impact.

Limitations to SRS Air Bag

In severe collisions such as those described previously in "SRS Air Bag Deployment Criteria", the applicable SRS air bag equipment will deploy. However, in some accidents, the equipment may not deploy depending on the type of collision and its severity.

Limitations to front/near front collision detection:

The following illustrations are examples of front/near front collisions that may not be detected as severe enough to deploy the SRS air bag equipment.

Impacts involving trees or poles

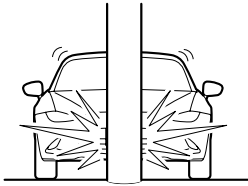

Frontal offset impact to the vehicle

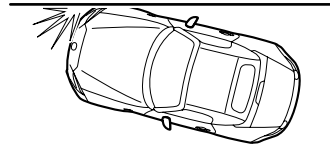

Rear-ending or running under a truck's tail gate

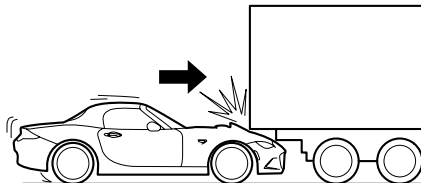

Limitations to side collision detection:

The following illustrations are examples of side collisions that may not be detected as severe enough to deploy the SRS air bag equipment.

Side impacts involving trees or poles

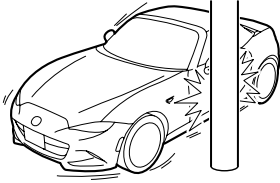

Side impacts with two-wheeled vehicles

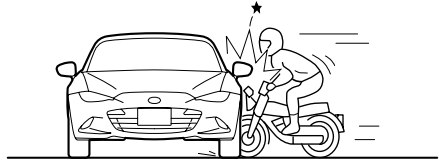

Roll-over



Passenger Occupant Classification System*

First, please read "Supplemental Restraint System (SRS) Precautions" (page 2-24) carefully.

▼ Passenger Occupant Classification Sensor

Your vehicle is equipped with a passenger occupant classification sensor as a part of the supplemental restraint system. This sensor is equipped in the passenger's seat cushion. This sensor measures the electrostatic capacity of the passenger's seat. The SAS unit is designed to prevent the passenger front and side air bags and seat belt pretensioner system from deploying if the passenger air bag deactivation indicator light turns on.

To reduce the chance of injuries caused by deployment of the passenger air bag, the system deactivates the passenger front and side air bags and also the seat belt pretensioner system when the passenger air bag deactivation indicator light turns on. Refer to the following table for the passenger air bag deactivation indicator light illumination conditions.

This system shuts off the passenger front and side air bags and seat belt pretensioner system, so make sure the passenger air bag deactivation indicator light turns on according to the following table.

The air bag/seat belt pretensioner system warning light flashes and the passenger air bag deactivation indicator light illuminates if the sensors have a possible malfunction. If this happens, the passenger front and side air bags and seat belt pretensioner system will not deploy.

Passenger air bag deactivation indicator light

This indicator light turns on to remind you that the passenger front and side air bags and seat belt pretensioner will not deploy during a collision.

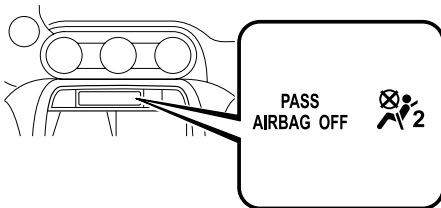

SRS Air Bags

If the passenger occupant classification sensor is normal, the indicator light turns on when the ignition is switched ON. The light turns off after a few seconds. Then, the indicator light turns on or is off under the following conditions:

Passenger air bag deactivation indicator light on/off condition chart

Condition detected by the passenger occupant classification system	Passenger air bag deactivation indicator light	Passenger front and side air bags	Passenger seat belt pretensioner system
Empty (Not occupied)	On	Deactivated	Deactivated
A child is seated in a child-restraint system ^{*1}	On	Deactivated	Deactivated
Adult ^{*2}	Off	Ready	Ready

*1 The occupant classification sensor may not detect a child seated on the seat, in a child-restraint system, or a junior seat depending on the child's physical size and seated posture.

*2 If a smaller adult sits on the passenger seat, the sensors might detect the person as being a child depending on the person's physique.

If the passenger air bag deactivation indicator light does not turn on when the ignition is switched ON and does not turn on as indicated in the passenger air bag deactivation indicator light on/off condition chart, do not allow an occupant to sit in the passenger seat and consult an Authorized Mazda Dealer as soon as possible. The system may not work properly in an accident.

! WARNING

Do not allow an occupant in the passenger's seat to sit with a posture which makes it difficult for the passenger occupant classification sensor to detect the occupant correctly:

Sitting in the passenger's seat with a posture which makes it difficult for the passenger occupant classification sensor to detect the occupant correctly is dangerous. If the passenger occupant classification sensor cannot detect the occupant sitting on the passenger's seat correctly, the passenger front and side air bags and pretensioner system may not operate (non-deploy) or they may operate (deploy) accidentally. The passenger will not have the supplementary protection of the air bags or the accidental operation (deployment) of the air bags could result in serious injury or death.

Under the following conditions, the passenger occupant classification sensor cannot detect a passenger sitting on the passenger's seat correctly and the deployment/non-deployment of the air bags cannot be controlled as indicated in the passenger air bag deactivation indicator light on/off condition chart. For example:

- A passenger is seated as shown in the following figure:

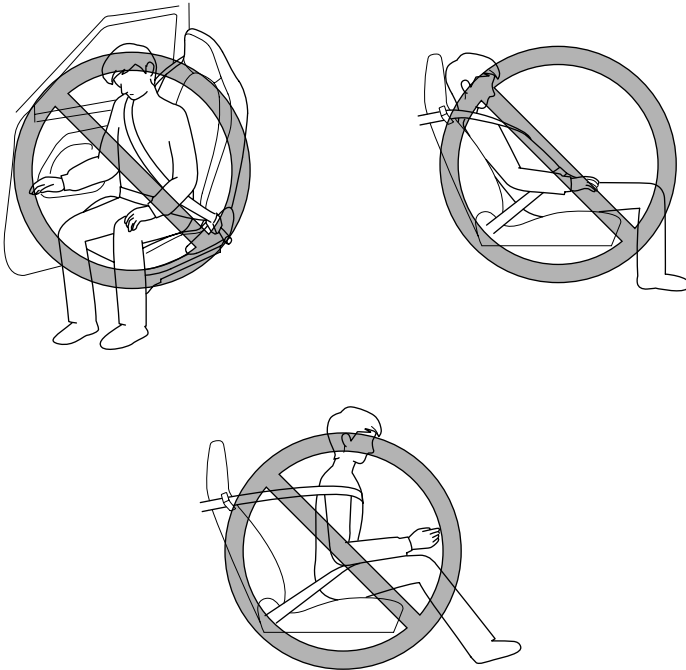

SRS Air Bags

- *Luggage or other items placed under the passenger seat or between the passenger seat and driver seat that push up the passenger seat bottom.*
- *An object, such as a seat cushion, is put on the passenger's seat or between the passenger's back and the seatback.*
- *A seat cover is put on the passenger's seat.*
- *Luggage or other items are placed on the seat with the child in the child-restraint system.*
- *The seat is washed.*
- *Liquids are spilled on the seat.*
- *The passenger seat is moved backward, pushing into luggage or other items placed behind it.*
- *Luggage or other items are placed between the passenger seat and driver seat.*
- *An electric device is put on the passenger's seat.*
- *An additional electrical device, such as a seat warmer is installed to the surface of the passenger seat.*

The passenger front and side air bags and seat belt pretensioner systems will deactivate if the passenger air bag deactivation indicator light turns on.

CAUTION

- *To assure proper deployment of the front air bag and to prevent damage to the sensor in the seat cushion:*
 - *Do not place sharp objects on the seat cushion or leave heavy luggage on them.*
 - *Do not spill any liquids on the seats or under the seats.*
- *To allow the sensors to function properly, always perform the following:*
 - *Adjust the seats as far back as possible and always sit upright against the seatbacks with seat belts worn properly.*
 - *If you place your child on the passenger seat, secure the child-restraint system properly and slide the passenger seat as far back as possible.*

NOTE

- *The system requires about 10 seconds to alternate between turning the passenger front and side air bags and seat belt pretensioner system on or off.*
- *The passenger air bag deactivation indicator light may turn on repeatedly if luggage or other items are put on the passenger seat, or if the temperature of the vehicle's interior changes suddenly.*
- *The passenger air bag deactivation indicator light may turn on for 10 seconds if the electrostatic capacity on the passenger seat changes.*
- *The air bag/seat belt pretensioner system warning light might turn on if the passenger seat receives a severe impact.*
- *If the passenger air bag deactivation indicator light does not turn on after installing a child-restraint system on the passenger seat, first, re-install your child-restraint system according to the procedure in this owner's manual. Then, if the passenger air bag deactivation indicator light still does not turn on, and consult an Authorized Mazda Dealer as soon as possible.*
- *If the passenger air bag deactivation indicator light turns on when an occupant is seated directly in the passenger seat, have the passenger re-adjust their posture by sitting with their feet on the floor, and then re-fastening the seat belt. If the passenger air bag deactivation indicator light remains turned on, slide the passenger seat as far back as possible. Consult an Authorized Mazda Dealer as soon as possible.*

Constant Monitoring

The following components of the air bag systems are monitored by a diagnostic system:

- Crash sensors, and diagnostic module (SAS unit)
- Front air bag sensors
- Air bag modules
- Side crash sensors
- Air bag/Seat belt pretensioner system warning light
- Seat belt pretensioners
- Related wiring

(With Passenger Occupant Classification System)

- Passenger air bag deactivation indicator light
- Passenger occupant classification sensor
- Passenger occupant classification module

The diagnostic module continuously monitors the system's readiness. This begins when the ignition is switched ON and continues while the vehicle is being driven.

3

Before Driving

Use of various features, including keys, doors, mirrors and windows.

Keys	3-2	Convertible Top	
Keys	3-2	(Retractable Fastback)	3-39
Keyless Entry System	3-3	Convertible Top (Retractable	
		Fastback)	3-39
Advanced Keyless Entry System	3-8		
Advanced Keyless Entry		Security System	3-47
System*	3-8	Modification and Add-On	
Operational Range	3-9	Equipment	3-47
		Immobilizer System	3-47
Doors and Locks	3-10	Theft-Deterrent System*	3-49
Door Locks.....	3-10		
Trunk Lid	3-18	Driving Tips	3-51
Inside Trunk Release Lever*	3-20	Break-In Period	3-51
		Saving Fuel and Protection of the	
Fuel and Emission	3-22	Environment.....	3-51
Fuel and Engine Exhaust		Hazardous Driving	3-52
Precautions	3-22	Floor Mat	3-52
Fuel-Filler Lid and Cap.....	3-25	Rocking the Vehicle	3-53
		Winter Driving	3-53
Steering Wheel	3-27	Driving In Flooded Area	3-55
Steering Wheel	3-27	Overloading.....	3-55
		Driving on Uneven Road	3-56
Mirrors	3-28		
Mirrors	3-28	Towing	3-57
		Trailer Towing.....	3-57
Windows	3-31	Recreational Towing	3-57
Power Windows	3-31		
Convertible Top (Soft Top)	3-34		
Convertible Top (Soft Top)	3-34		

Keys

WARNING

Do not leave the key in your vehicle with children and keep them in a place where your children will not find or play with them:

Leaving children in a vehicle with the key is dangerous. This could result in someone being badly injured or even killed. Children may find these keys to be an interesting toy to play with and could cause the power windows or other controls to operate, or even make the vehicle move.

CAUTION

- *Because the key (transmitter) uses low-intensity radio waves, it may not function correctly under the following conditions:*
 - *The key is carried with communication devices such as cellular phones.*
 - *The key contacts or is covered by a metal object.*
 - *The key is near electronic devices such as personal computers.*
 - *Non-Mazda genuine electronic equipment is installed in the vehicle.*
 - *There is equipment which discharges radio waves near the vehicle.*
- *The key (transmitter) may consume battery power excessively if it receives high-intensity radio waves. Do not place the key near electronic devices such as televisions or personal computers.*

- *To avoid damage to the key (transmitter), DO NOT:*
 - *Drop the key.*
 - *Get the key wet.*
 - *Disassemble the key.*
 - *Expose the key to high temperatures on places such as the dashboard or hood, under direct sunlight.*
 - *Expose the key to any kind of magnetic field.*
 - *Place heavy objects on the key.*
 - *Put the key in an ultrasonic cleaner.*
 - *Put any magnetized objects close to the key.*

A code number is stamped on the plate attached to the key set; detach this plate and store it in a safe place (not in the vehicle) for use if you need to make a replacement key (auxiliary key). Also write down the code number and keep it in a separate safe and convenient place, but not in the vehicle.

If your key (auxiliary key) is lost, consult your Authorized Mazda Dealer and have your code number ready.

NOTE

The driver must carry the key to ensure the system functions properly.

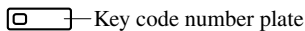
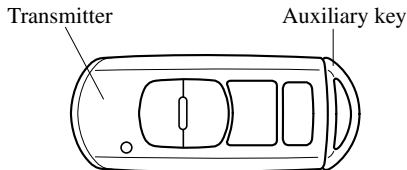

To use the auxiliary key, pull out the auxiliary key from the transmitter while pressing the knob.

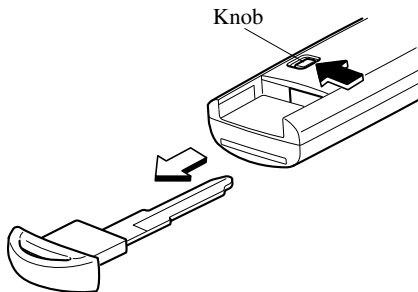
**Keyless Entry System**

This system uses the key buttons to remotely lock and unlock the doors and the fuel-filler lid, and opens the trunk lid. The system can start the engine without having to take the key out of your purse or pocket.

It can also help you signal for attention or help.

Operating the theft-deterrent system is also possible on theft-deterrent system-equipped vehicles.

System malfunctions or warnings are indicated by the following warning lights or beeps.

For vehicles with the type A instrument cluster, check the displayed message for more information and, if necessary, have the vehicle inspected at an Authorized Mazda Dealer, according to the indication.

- KEY Warning Light (Red)
Refer to Warning/Indicator Lights on page 4-26.
- Ignition Not Switched Off (STOP) Warning Beep
Refer to Ignition Not Switched Off (STOP) Warning Beep on page 7-49.
- Key Removed from Vehicle Warning Beep
Refer to Key Removed from Vehicle Warning Beep on page 7-50.

If you have a problem with the key, consult an Authorized Mazda Dealer.

If your key is lost or stolen, consult an Authorized Mazda Dealer as soon as possible for a replacement and to make the lost or stolen key inoperative.

Keys

CAUTION

Radio equipment like this is governed by laws in the United States. Changes or modifications not expressly approved by the party responsible for compliance could void the user's authority to operate the equipment.

NOTE

- The keyless entry system operation may vary due to local conditions.
- The keyless entry system is fully operational (door/fuel-filler lid lock/unlock) when the ignition is switched off. The system does not operate if the ignition is switched to any position other than off.
- If the key does not operate when pressing a button or the operational range becomes too small, the battery may be weak. To install a new battery, refer to Key Battery Replacement (page 6-38).
- Battery life is about one year. Replace the battery with a new one if the KEY indicator light (green) flashes in the instrument cluster (for vehicles with a type A instrument cluster (page 4-26), messages are displayed in the instrument cluster). Replacing the battery about once a year is recommended because the KEY warning light/indicator light may not illuminate or flash depending on the rate of battery depletion.



- Additional keys can be obtained at an Authorized Mazda Dealer. Up to 6 keys can be used with the keyless functions per vehicle. Bring all keys to an Authorized Mazda Dealer when additional keys are required.

▼ Transmitter

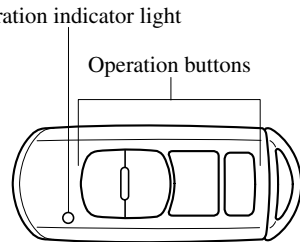

NOTE

- The headlights turn on/off by operating the transmitter. Refer to Leaving Home Light on page 4-49.
- **(With theft-deterrent system)**
The hazard warning lights flash when the theft-deterrent system is armed or turned off.
Refer to Theft-Deterrent System on page 3-49.
- **(With the advanced keyless function)**
A beep sound can be heard for confirmation when the doors and the fuel-filler lid are locked/unlocked using the key. If you prefer, the beep sound can be turned off.
The volume of the beep sound can also be changed.
Refer to Personalization Features on page 9-9.
Use the following procedure to change the setting.
 1. Switch the ignition off and close both of the doors and the trunk lid.
 2. Open the driver's door.

3. *Within 30 seconds of opening the driver's door, press and hold the LOCK button on the key for 5 seconds or longer. Both of the doors and the fuel-filler lid lock and the beep sound activates at the currently set volume. The setting changes each time the LOCK button on the key is pressed and the beep sound activates at the set volume. (If the beep sound has been set to not activate, it will not activate.)*
4. *The setting change is completed by doing any one of the following:*
 - *Switching the ignition to ACC or ON.*
 - *Closing the driver's door.*
 - *Opening the trunk lid.*
 - *Not operating the key for 10 seconds.*
 - *Pressing any button except the LOCK button on the key.*
 - *Pressing a request switch.*

The operation indicator light flashes when the buttons are pressed.

Lock button

To lock the doors and the fuel-filler lid, press the lock button and the hazard warning lights will flash once.

(With the advanced keyless function)

A beep sound will be heard once.

To confirm that both doors and the fuel-filler lid have been locked, press the lock button again within 5 seconds. If they are closed and locked, the horn will sound.



NOTE

- *The doors and the fuel-filler lid can be locked by pressing the lock button while any other door or the trunk lid is open. The hazard warning lights will not flash. When the lock button is pressed while any door is open and then the door is closed, both the doors and the fuel-filler lid are locked.*
- *Confirm that both doors and the fuel-filler lid are locked visually or audibly by use of the double click.*
- *Make sure both doors and the fuel-filler lid are locked after pressing the button.*
- **(With theft-deterrent system)**
When the doors are locked by pressing the lock button on the key while the theft-deterrent system is armed, the hazard warning lights will flash once to indicate that the system is armed.

Unlock button

To unlock the driver's door and the fuel-filler lid, press the unlock button and the hazard warning lights will flash twice.

(With the advanced keyless function)

A beep sound will be heard twice.

To unlock both doors and the fuel-filler lid, press the unlock button again within 3 seconds and two more beep sounds will be heard.



Keys

NOTE

- The system can be set to unlock both doors by performing a single operation. Refer to Personalization Features on page 9-9.

Use the following procedure to change the setting.

1. Switch the ignition off and close both of the doors and the trunk lid.
2. Open the driver's door.
3. Within 30 seconds of opening the driver's door, press and hold the UNLOCK button on the key for 5 seconds or longer (the sound of the doors locking/unlocking can be heard).

After this, the system switches the setting each time the UNLOCK button is pressed (the sound of the doors locking/unlocking can be heard).

4. The setting change is completed by doing any one of the following:

- Switching the ignition to ACC or ON.
- Closing the driver's door.
- Opening the trunk lid.
- Not operating the key for 10 seconds.
- Pressing any button except the UNLOCK button on the key.
- Pressing a request switch.

• (Auto re-lock function)

After unlocking with the key, both doors and the fuel-filler lid will automatically lock if any of the following operations are not performed within about 60 seconds. If your vehicle has a theft-deterrent system, the hazard warning lights will flash for confirmation.

The time required for the doors to lock automatically can be changed.

Refer to Personalization Features on page 9-9.

- A door or the trunk lid is opened.
- The ignition is switched to any position other than off.

• (With theft-deterrent system)

When the doors are unlocked by pressing the unlock button on the key while the theft-deterrent system is turned off, the hazard warning lights will flash twice to indicate that the system is turned off.

Trunk button

To open the trunk lid, press and hold the trunk button until the trunk lid opens.

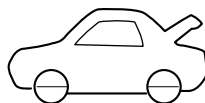

HOLD

Panic button

If you witness from a distance someone attempting to break into or damage your vehicle, press and hold the panic button to activate the vehicle's alarm. Call emergency services if necessary.

! HOLD

NOTE

The panic button will work whether any door or the trunk lid is open or closed.

(Turning on the alarm)

Pressing the panic button for 1 second or more will trigger the alarm for about 2 minutes and 30 seconds, and the following will occur:

- The horn sounds intermittently.
- The hazard warning lights flash.

(Turning off the alarm)

The alarm stops by pressing any button on the key.

▼ Operational Range

The system operates only when the driver is in the vehicle or within operational range while the key is being carried.

Starting the Engine

NOTE

- *Starting the engine may be possible even if the key is outside of the vehicle and extremely close to a door and window, however, always start the engine from the driver's seat. If the vehicle is started and the key is not in the vehicle, the vehicle will not restart after it is shut off and the ignition is switched to off.*
- *The trunk is out of the assured operational range, however, if the key (transmitter) is operable the engine will start.*

With the advanced keyless function

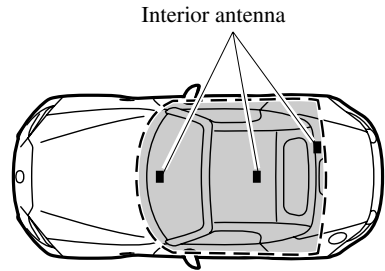

Operational range

Without the advanced keyless function

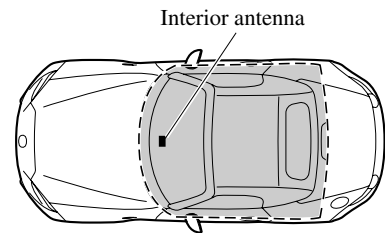

Operational range

NOTE

The engine may not start if the key is placed in the following areas:

- *Around the dashboard*
- *In the storage compartments or the center console*

▼ Key Suspend Function

If a key is left in the vehicle, the functions of the key left in the vehicle are temporarily suspended to prevent theft of the vehicle.

To restore the functions, press the unlock button on the functions-suspended key in the vehicle.

Advanced Keyless Entry System

Advanced Keyless Entry System*

WARNING

Radio waves from the key may affect medical devices such as pacemakers:

Before using the key near people who use medical devices, ask the medical device manufacturer or your physician if radio waves from the key will affect the device.

The advanced keyless function allows you to lock/unlock the door, or open the trunk lid while carrying the key.

System malfunctions or warnings are indicated by the following warning lights or beeps.

- Request switch Inoperable Warning Beep
Refer to Request Switch Inoperable Warning Beep (With the advanced keyless function) on page 7-50.
- Key Left-in-Trunk Warning Beep
Refer to Key Left-in-luggage Compartment Warning Beep (With the advanced keyless function) on page 7-50.
- Key Left-in-vehicle Warning Beep
Refer to Key Left-in-vehicle Warning Beep (With the advanced keyless function) on page 7-50.

NOTE

The advanced keyless entry system functions can be deactivated to prevent any possible adverse effect on a user wearing a pacemaker or other medical device. If the system is deactivated, you will be unable to start the engine by carrying the key. Consult an Authorized Mazda Dealer for details. If the advanced keyless entry system has been deactivated, you can start the engine by following the procedure indicated when the key battery goes dead.

Refer to Engine Start Function When Key Battery is Dead on page 4-8.

Advanced Keyless Entry System

Operational Range

The system operates only when the driver is in the vehicle or within operational range while the key is being carried.

NOTE

When the battery power is low, or in places where there are high-intensity radio waves or noise, the operational range may become narrower or the system may not operate. For determining battery replacement, Refer to Keyless Entry System on page 3-3.

▼ Locking, Unlocking the Doors

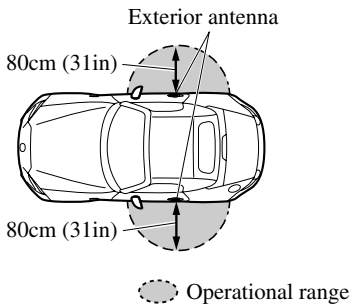

NOTE

- The system may not operate if you are too close to the windows or door handles.
- If the key is left in the following areas and you leave the vehicle, the doors may be locked depending on the radio wave conditions even if the key is left in the vehicle.
 - Around the dashboard
 - In the storage compartments or the center console
 - Next to a communication device such as a mobile phone

▼ Opening the Trunk Lid

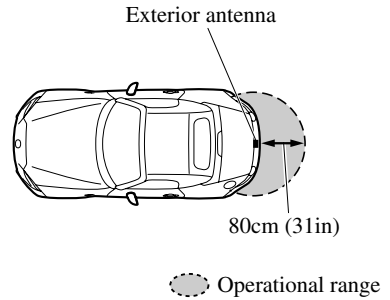

Doors and Locks

Door Locks

WARNING

Always take all children and pets with you or leave a responsible person with them:

Leaving a child or a pet unattended in a parked vehicle is dangerous. In hot weather, temperatures inside a vehicle can become high enough to cause brain damage or even death.

Do not leave the key in your vehicle with children and keep them in a place where your children will not find or play with them:

Leaving children in a vehicle with the key is dangerous. This could result in someone being badly injured or even killed.

Keep both doors locked when driving:

Unlocked doors in a moving vehicle are dangerous. Passengers can fall out if a door is accidentally opened and can more easily be thrown out in an accident.

Always close both the windows and convertible top, lock the doors and take the key with you when leaving your vehicle unattended:

Leaving your vehicle unlocked is dangerous as children could lock themselves in a hot vehicle, which could result in death. Also, a vehicle left unlocked becomes an easy target for thieves and intruders.

After closing the doors, always verify that they are securely closed:

Doors not securely closed are dangerous, if the vehicle is driven with a door not securely closed, the door could open unexpectedly resulting in an accident.

Always confirm the safety around the vehicle before opening a door:

Suddenly opening a door is dangerous. A passing vehicle or a pedestrian could be hit and cause an accident.

CAUTION

- *Always confirm the conditions around the vehicle before opening/closing the doors and use caution during strong winds or when parked on an incline. Not being aware of the conditions around the vehicle is dangerous because fingers could get caught in the door or a passing pedestrian could be hit, resulting in an unexpected accident or injury.*
- *If the power window does not go up or down automatically because the battery is dead, slowly open/close the power window while pressing the glass inward. Otherwise, the power window may contact the convertible top and the door cannot be opened/closed resulting in damage to the window.*

NOTE

- *Always stop the engine and lock the doors. In addition, to prevent theft of valuables, do not leave them inside the cabin.*
- *If the key is left in the following areas and you leave the vehicle, the doors may be locked depending on the radio wave conditions even if the key is left in the vehicle.*
 - *Around the dashboard*
 - *In the storage compartments or the center console*
 - *Next to a communication device such as a mobile phone*
- *When the ignition is switched to ACC or ON, the vehicle lock-out prevention feature prevents you from locking yourself out of the vehicle. Both doors will automatically unlock if they are locked using the power door locks with any door open. If both the doors are closed even though the trunk lid is open, both the doors will lock. The vehicle lock-out prevention feature does not operate while the ignition is switched off. When any door is opened from the outside while the key is inside the vehicle, the closed doors are locked. Both the doors are automatically unlocked by closing the open door. **(With the advanced keyless function)** The beep sound is heard for about 10 seconds to notify the driver that the key has been left in the vehicle. **(Without the advanced keyless function)** The horn sound is heard twice to notify the driver that the key has been left in the vehicle.*

- **(Door unlock (control) system with collision detection)***
This system automatically unlocks the doors in the event the vehicle is involved in an accident to allow passengers to get out of the vehicle immediately and prevent being trapped inside. While the ignition is switched ON and in the event the vehicle receives an impact strong enough to inflate the air bags, both the doors are automatically unlocked after about 6 seconds have elapsed from the time of the accident. The doors may not unlock depending on how an impact is applied, the force of the impact, and other conditions of the accident. If door-related systems or the battery is malfunctioning, the doors will not unlock.
- *When opening a door, the power windows open a little automatically. When closing the door, the power windows close automatically. This is a function for improving the sealability, and it does not mean there is a problem. If the vehicle battery is disconnected for vehicle maintenance or other reasons, the power windows will not open or close automatically. If the power windows do not open or close, the automatic open/close mechanism for the windows must be reset. Refer to Operating the Power Windows on page 3-31.*

Doors and Locks

▼ Locking, Unlocking with Auxiliary Key

Both doors and the fuel-filler lid lock automatically when the driver's door is locked using the auxiliary key. Both doors and the fuel-filler lid unlock when the driver's door is unlocked and the auxiliary key is held in the unlock position for one second or longer. Turn the auxiliary key toward the front to lock, toward the back to unlock.

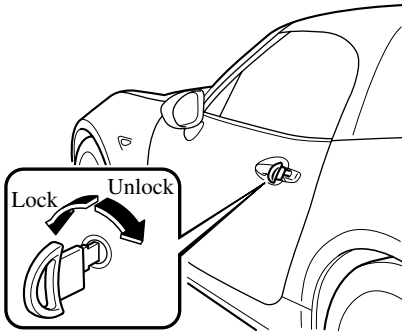

NOTE

Holding the auxiliary key in the unlocked position in the driver's door lock for about a second unlocks both doors. To unlock the driver's door and the fuel-filler lid, insert the auxiliary key into the driver's door lock and turn the auxiliary key briefly to the unlock position and then immediately return it to the center position.

▼ Locking, Unlocking with Request Switch (With the advanced keyless function)

Both doors and the fuel-filler lid can be locked/unlocked by pressing the request switch while the key is being carried.

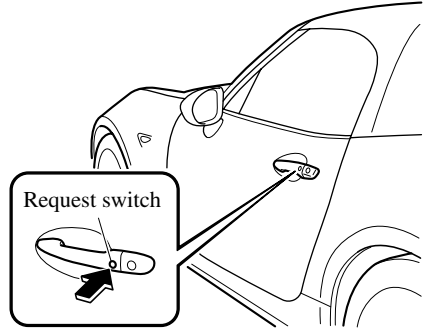

To lock

To lock the doors and the fuel-filler lid, press the request switch and the hazard warning lights will flash once. A beep sound will be heard once.

To unlock

Driver's door request switch

To unlock the driver's door and the fuel-filler lid, press the request switch. A beep sound will be heard twice and the hazard warning lights will flash twice.

To unlock both doors and the fuel-filler lid, press the request switch again within 3 seconds and two more beep sounds will be heard.

Front passenger door request switch

To unlock both doors and the fuel-filler lid, press the request switch. A beep sound will be heard twice and the hazard warning lights will flash twice.

NOTE

- *The system can be set to unlock both doors and the fuel-filler lid by performing a single operation. Refer to Personalization Features on page 9-9. Use the following procedure to change the setting.*
 1. *Switch the ignition off and close both of the doors and the trunk lid.*
 2. *Open the driver's door.*
 3. *Within 30 seconds of opening the driver's door, press and hold the UNLOCK button on the key for 5 seconds or longer (the sound of the doors locking/unlocking can be heard). After this, the system switches the setting of pressing the driver's request switch once or twice to unlock both doors each time the UNLOCK button is pressed (the sound of the doors locking/unlocking can be heard).*
 4. *The setting change is completed by doing any one of the following:*
 - *Switching the ignition to ACC or ON.*
 - *Closing the driver's door.*
 - *Opening the trunk lid.*
 - *Not operating the key for 10 seconds.*
 - *Pressing any button except the UNLOCK button on the key.*
 - *Pressing a request switch.*
- *Confirm that both doors and the fuel-filler lid are securely locked.*
- *Both doors and the fuel-filler lid cannot be locked when any door is open.*
- *It may require a few seconds for the doors to unlock after the request switch is pressed.*

- *A beep sound is heard for confirmation when the doors and the fuel-filler lid are locked/unlocked using the request switch. If you prefer, the beep sound can be turned off.*

The volume of the beep sound can also be changed. Refer to Personalization Features on page 9-9.

Use the following procedure to change the setting.

1. *Switch the ignition off and close both of the doors and the trunk lid.*
2. *Open the driver's door.*
3. *Within 30 seconds of opening the driver's door, press and hold the LOCK button on the key for 5 seconds or longer. Both of the doors and the fuel-filler lid lock and the beep sound activates at the currently set volume. The setting changes each time the LOCK button on the key is pressed and the beep sound activates at the set volume. (If the beep sound has been set to not activate, it will not activate.)*
4. *The setting change is completed by doing any one of the following:*
 - *Switching the ignition to ACC or ON.*
 - *Closing the driver's door.*
 - *Opening the trunk lid.*
 - *Not operating the key for 10 seconds.*
 - *Pressing any button except the LOCK button on the key.*
 - *Pressing a request switch.*

Doors and Locks

- **(With theft-deterrent system)**

The hazard warning lights flash when the theft-deterrent system is armed or turned off.

Refer to Theft-Deterrent System on page 3-49.

- The setting can be changed so that the doors and the fuel-filler lid are locked automatically without pressing the request switch.

Refer to Personalization Features on page 9-9.

- **(Auto-lock function)**

A beep sound is heard when both doors are closed while the advanced key is being carried. Both doors and the fuel-filler lid are locked automatically after about three seconds when the advanced key is out of the operational range. Also, the hazard warning lights flash once. (Even if the driver is in the operational range, both doors and the fuel-filler lid are locked automatically after about 30 seconds.) If you are out of the operational range before the doors and the trunk lid are completely closed or another key is left in the vehicle, the auto-lock function will not work. Always make sure that both doors and the trunk lid are closed and locked before leaving the vehicle. The auto-lock function does not close the power windows.

- **Auto re-lock function**

After unlocking with the request switch, both doors and the fuel-filler lid will automatically lock if any of the following operations are not performed within about 60 seconds. If your vehicle has a theft-deterrent system, the hazard warning lights will flash for confirmation.

The time required for the doors and the fuel-filler lid to lock automatically can be changed.

Refer to Personalization Features on page 9-9.

- Opening a door or the trunk lid.
- Switching the ignition to any position other than off.

▼ Locking, Unlocking with Transmitter

Both doors and the fuel-filler lid can be locked/unlocked by operating the keyless entry system transmitter, refer to Keyless Entry System (page 3-3).

▼ Locking, Unlocking with Door-Lock Switch

Both doors and the fuel-filler lid lock automatically when the lock side is pressed. They unlock when the unlock side is pressed.

Driver's door

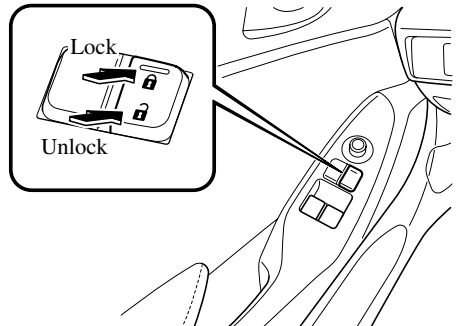

Front passenger's door

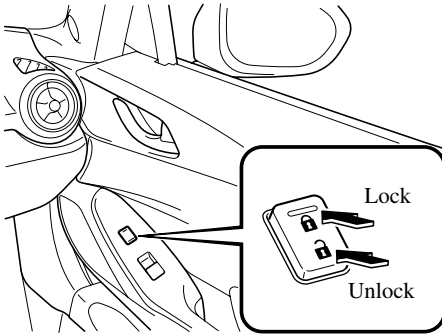

To lock both the doors and the fuel-filler lid from an open door, press the lock side of the door lock switch and then close the door.

NOTE

When locking the doors this way, be careful not to leave the key inside the vehicle.

▼ **Auto Lock/Unlock Function****! WARNING****Do not pull the inner handle on a door:**

Pulling the inner handle on a door while the vehicle is moving is dangerous. Passengers can fall out of the vehicle if the door opens accidentally, which could result in death or serious injury.

- When the vehicle speed exceeds 20 km/h (12 mph), both doors and the fuel-filler lid lock automatically.
- When the ignition is switched off, both doors and the fuel-filler lid unlock automatically.

These functions can also be disabled so that they do not operate.

Auto lock/unlock function setting change using door-lock switch

The doors and the fuel-filler lid can be set to lock or unlock automatically by selecting any one of the functions from the following table and using the driver's door-lock switch on the interior door panel.

NOTE

- *Function number 3 in the following table is the factory setting for your vehicle.*
- *There are only a total of six auto lock/unlock settings available for automatic transmission vehicles, and three for manual transmission vehicles. Be sure to press the unlock side of the driver's door-lock switch the correct number of times according to the selected function number. If the switch is mistakenly pressed seven times on an automatic transmission vehicle or four times on a manual transmission, the procedure will be cancelled. If this occurs, start the procedure from the beginning.*

Function number	Function ^{*1}
1	The auto door-lock function is disabled.
2	Both the doors and the fuel-filler lid lock automatically when the vehicle speed is about 20 km/h (12 mph) or more.
3 (Factory Setting)	Both the doors and the fuel-filler lid lock automatically when the vehicle speed is about 20 km/h (12 mph) or more. Both the doors and the fuel-filler lid unlock when the ignition is switched from ON to Off.
4	(Automatic transmission vehicles only) When the ignition is switched ON and the selector lever is shifted from park (P) to any other gear position, both the doors and the fuel-filler lid lock automatically.

Doors and Locks

Function number	Function*1
5	<p>(Automatic transmission vehicles only) When the ignition is switched ON and the selector lever is shifted from park (P) to any other gear position, both the doors and the fuel-filler lid lock automatically. When the selector lever is shifted to park (P) while the ignition is switched ON, both the doors and the fuel-filler lid unlock automatically.</p>
6	<p>(Automatic transmission vehicles only) Both the doors and the fuel-filler lid lock automatically when the vehicle speed is about 20 km/h (12 mph) or more. When the selector lever is shifted to park (P) while the ignition is switched ON, both the doors and the fuel-filler lid unlock automatically.</p>

*1 Other settings for the auto door lock function are available at an Authorized Mazda Dealer. For details consult an Authorized Mazda Dealer. Refer to Personalization Features on page 9-9.

Settings can be changed using the following procedure.

1. Safely park the vehicle. Both doors must remain closed.
2. Switch the ignition ON.
3. Press and hold the lock side of the driver's door-lock switch within 20 seconds of switching the ignition ON, and make sure a beep sound is heard about eight seconds afterwards.
4. Refer to the auto lock/unlock function setting table, determine the function number for the desired setting. Press the unlock side of the driver's door-lock switch the same number of times as the selected function number (Ex. If you select function 2, press the unlock side of the switch only 2 times).

5. Three seconds after the function setting has been changed, a beep sound will beep in the amount of the selected function number. (Ex. Function number 3 = 3 beep sounds)

(Manual transmission vehicles)

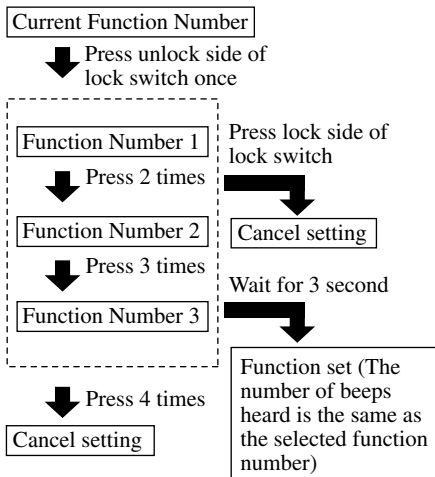

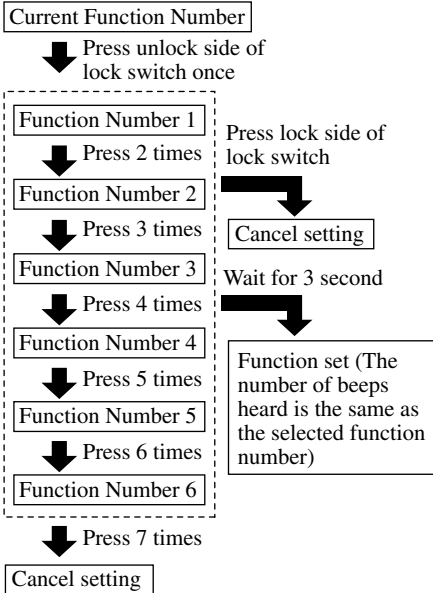
(Automatic transmission vehicles)**NOTE**

- The doors cannot be locked or unlocked while the setting function is being performed.
- The procedure can be cancelled by pressing the lock side of the driver's door-lock switch.

▼ Locking, Unlocking with Door-Lock Knob**Operation from inside**

To lock any door from the inside, press the door-lock knob.

To unlock, pull it outward.

This does not operate the other door locks.

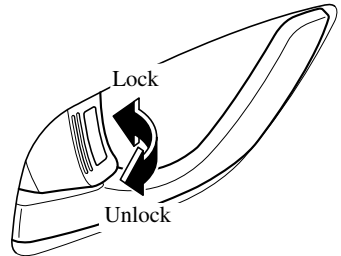
**NOTE**

The red indication can be seen when the door-lock knob is unlocked.

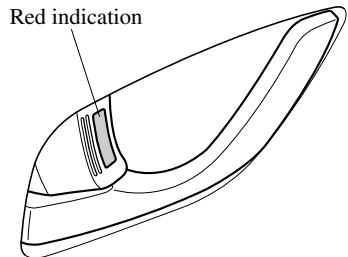

Doors and Locks

Operation from outside

To lock the passenger door with the door-lock knob from the outside, press the door-lock knob to the lock position and close the door (holding the door handle in the open position is not required).

This does not operate the other door locks.

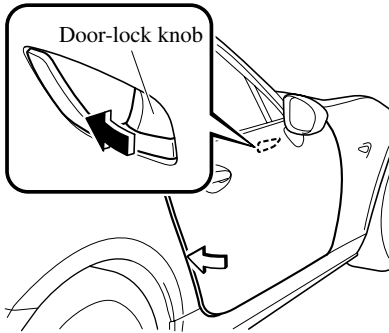

NOTE

When locking the door this way:

- Be careful not to leave the key inside the vehicle.
- The driver's door lock knob cannot be used while the driver's door is open.

Trunk Lid

! WARNING

Never allow a person to ride in the trunk:

Allowing a person to ride in the trunk is dangerous. The person in the trunk could be seriously injured or killed during sudden braking or a collision.

Do not drive with the trunk lid open:

Exhaust gas in the cabin of a vehicle is dangerous. An open trunk lid in a moving vehicle will cause exhaust gas to be drawn into the cabin. This gas contains CO (carbon monoxide), which is colorless, odorless, and highly poisonous, and it can cause loss of consciousness and death. Moreover, an open trunk lid could cause occupants to fall out in an accident.

! CAUTION

- Before opening the trunk lid, remove any snow and ice accumulation on it. Otherwise, the trunk lid could close under the weight of the snow and ice resulting in injury.
- Be careful when opening/closing the trunk lid during strong winds. If a strong gust blows against the trunk lid, it could close suddenly resulting in injury.
- Fully open the trunk lid and make sure that it stays open. If the trunk lid is only opened partially, it could slam shut by vibration or wind gusts resulting in injury.
- When loading or unloading luggage in the trunk, turn off the engine. Otherwise, you could get burned by the heat of the exhaust gas.

▼ Opening and Closing the Trunk Lid

Opening the trunk lid

Using the remote release button

Push the release button.

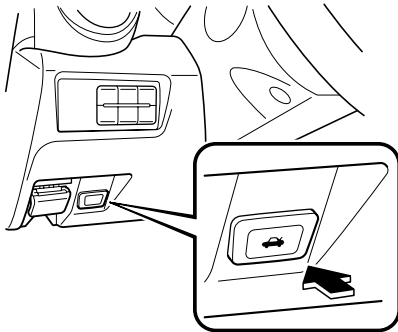

The remote release button function can be disabled by locking the doors using the transmitter, auxiliary key, or a request switch to prevent an intruder in the vehicle from opening the trunk.

To enable the remote release button operation, unlock the doors by using the transmitter, auxiliary key, or a request switch, or switch the ignition ON.

NOTE

The remote release button cannot be disabled by locking the doors using the door-lock switch/door-lock knob.

Refer to Locking, Unlocking with Door-Lock Switch on page 3-14.

Refer to Locking, Unlocking with Door-Lock Knob on page 3-17.

Using the electric trunk lid opener (With the advanced keyless function)

A trunk lid can also be opened while the key is being carried.

Press the electric trunk lid opener and raise the trunk lid when the latch releases.

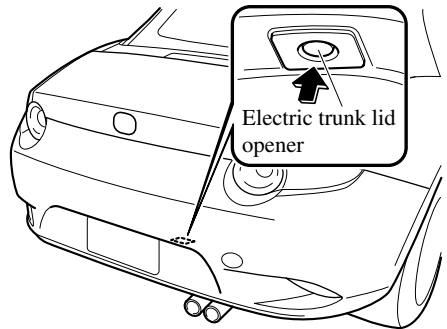

NOTE

- *When opening the trunk lid with the doors locked, it may require a few seconds for the trunk lid latch to release after the electric trunk lid opener is pressed.*
- *The trunk lid can be closed when the doors are locked with the key left in the vehicle. However, to prevent locking the key in the vehicle, the trunk lid can be opened by pressing the electric trunk lid opener. If the trunk lid cannot be opened despite doing this procedure, first push the trunk lid completely closed, then press the electric trunk lid opener to fully open the trunk lid.*
- *If the vehicle battery is dead or there is a malfunction in the electrical system and the trunk lid cannot be unlocked, the trunk lid can be opened by performing the emergency procedure. Refer to When Trunk Lid Cannot be Opened on page 7-52.*

Doors and Locks

Closing the trunk lid

Use both hands to push the trunk lid down until the lock snaps shut. Do not slam it. Pull up on the trunk lid to make sure it is secure.

Inside Trunk Release Lever*

Your vehicle is equipped with an inside trunk release lever that provides a means of escape for children and adults in the event they become locked inside the trunk.

No matter how careful adults might be with keys and locking their cars, parents should be aware that children may be tempted to play around vehicles and use the trunk as a hiding place.

Adults are advised to familiarize themselves with the operation and location of the inside trunk release lever so that all children can be told about it in an appropriate way, keeping in mind that most vehicles do not have such levers.

WARNING

Close the trunk lid, do not allow children to play inside the trunk:

Leaving the trunk lid open or leaving children in the vehicle with the keys is dangerous. Children could open the trunk lid and climb inside resulting in possible injury or death from heat exposure.

Always keep the car from being a tempting place to play by latching the doors and the trunk, and keeping the keys where children can not play with them:

Leaving children or animals unattended in a parked vehicle is dangerous. Babies left sleeping and children who lock themselves in cars or trunks can die very quickly from heat prostration. Do not leave your children or pets alone in a car at any time. Do not leave the car, the trunk unlocked.

▼ Opening the Trunk Lid from the Inside

Slide the inside trunk release lever in the direction of the arrow. The lever is made of material that will glow for hours in the darkness of the trunk following a brief exposure to ambient light.

The inside trunk release lever is located on the inside of the trunk lid.

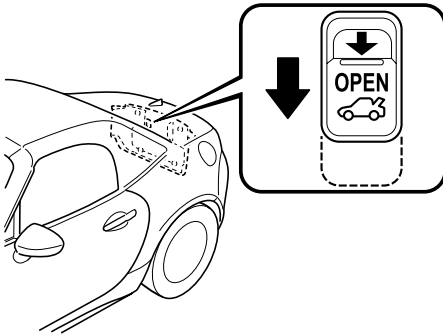

Fuel and Emission

Fuel and Engine Exhaust Precautions

▼ Fuel Requirements

Vehicles with catalytic converters or oxygen sensors must use **ONLY UNLEADED FUEL**, which will reduce exhaust emissions and keep spark plug fouling to a minimum.

This vehicle will perform best with fuel listed in the table.

Fuel	Octane Rating* (Anti-knock index)
Premium unleaded fuel	91 [(R+M)/2 method] or above (96 RON or above)

* U.S. federal law requires that octane ratings be posted on gasoline station pumps.

Regular unleaded fuel with an octane rating from 87 to 90 (91 to 95 RON) can be used, but this will reduce performance slightly, such as reduced engine output, and engine knocking. Fuel with a rating lower than 87 octane (91 RON) will negatively affect the emission control system performance and could also cause engine knocking and serious engine damage.

CAUTION

➤ **USE ONLY UNLEADED FUEL.**

Leaded fuel is harmful to the catalytic converter and oxygen sensors and will lead to deterioration of the emission control system and or failures.

➤ *This vehicle can only use oxygenated fuels containing no more than 10 % ethanol by volume. Damage to the vehicle may occur when ethanol exceeds this recommendation, or if the gasoline contains any methanol. Stop using gasohol of any kind if your vehicle engine is performing poorly.*

➤ *Never add fuel system additives, otherwise the emission control system could be damaged. Consult an Authorized Mazda Dealer for details.*

Gasoline blended with oxygenates such as alcohol or ether compounds are generally referred to as oxygenated fuels. The common gasoline blend that can be used with your vehicle is ethanol blended at no more than 10 %. Gasoline containing alcohol, such as ethanol or methanol, may be marketed under the name "Gasohol".

Vehicle damage and drivability problems resulting from the use of the following may not be covered by the warranty.

- Gasohol containing more than 10 % ethanol.
- Gasoline or gasohol containing methanol.
- Leaded fuel or leaded gasohol.

▼ Emission Control System

This vehicle is equipped with an emission control system (the catalytic converter is part of this system) that enables the vehicle to comply with existing exhaust emissions requirements.

WARNING

Never park over or near anything flammable:

Parking over or near anything flammable, such as dry grass, is dangerous. Even with the engine turned off, the exhaust system remains very hot after normal use and could ignite anything flammable. A resulting fire could cause serious injury or death.

CAUTION

Ignoring the following precautions could cause lead to accumulate on the catalyst inside the converter or cause the converter to get very hot. Either condition will damage the converter and cause poor performance.

- *USE ONLY UNLEADED FUEL.*
- *Do not drive your Mazda with any sign of engine malfunction.*
- *Do not coast with the ignition switched off.*
- *Do not descend steep grades in gear with the ignition switched off.*
- *Do not operate the engine at high idle for more than 2 minutes.*
- *Do not tamper with the emission control system. All inspections and adjustments must be made by a qualified technician.*
- *Do not push-start or pull-start your vehicle.*

NOTE

- *Under U.S. federal law, any modification to the original-equipment emission control system before the first sale and registration of a vehicle is subject to penalties. In some states, such modification made on a used vehicle is also subject to penalties.*
- *While the engine is off, the sound of a valve opening and closing can be heard at the rear of the vehicle, however this does not indicate an abnormality. The vehicle has a self-checking device and it operates while the engine is off.*

Fuel and Emission

▼ Engine Exhaust (Carbon monoxide)

WARNING

Do not drive your vehicle if you smell exhaust gas inside the vehicle:

Engine exhaust gas is dangerous. This gas contains carbon monoxide (CO), which is colorless, odorless, and poisonous. When inhaled, it can cause loss of consciousness and death. If you smell exhaust gas inside the vehicle, keep all windows fully open and contact an Authorized Mazda Dealer immediately.

Do not run the engine when inside an enclosed area:

Running the engine inside an enclosed area, such as a garage, is dangerous. Exhaust gas, which contains poisonous carbon monoxide, could easily enter the cabin. Loss of consciousness or even death could occur.

Open the windows or adjust the heating or cooling system to draw fresh air when idling the engine:

Exhaust gas is dangerous. When the vehicle is stopped with the windows closed and the engine running for a long time even in an open area, exhaust gas, which contains poisonous carbon monoxide, could enter the cabin. Loss of consciousness or even death could occur.

Clear snow from underneath and around your vehicle, particularly the tail pipe, before starting the engine:

Running the engine when a vehicle is stopped in deep snow is dangerous. The exhaust pipe could be blocked by the snow, allowing exhaust gas to enter the cabin. Because exhaust gas contains poisonous carbon monoxide, it could cause loss of consciousness or even death to occupants in the cabin.

Fuel-Filler Lid and Cap

! WARNING

When removing the fuel-filler cap, loosen the cap slightly and wait for any hissing to stop, then remove it:

Fuel spray is dangerous. Fuel can burn skin and eyes and cause illness if ingested. Fuel spray is released when there is pressure in the fuel tank and the fuel-filler cap is removed too quickly.

Before refueling, stop the engine, and always keep sparks and flames away from the filler neck:

Fuel vapor is dangerous. It could be ignited by sparks or flames causing serious burns and injuries. Additionally, use of the incorrect fuel-filler cap or not using a fuel-filler cap may result in a fuel leak, which could result in serious burns or death in an accident.

Do not continue refueling after the fuel pump nozzle shuts off automatically:

Continuing to add fuel after the fuel pump nozzle has shut off automatically is dangerous because overfilling the fuel tank may cause fuel overflow or leakage. Fuel overflow and leakage could damage the vehicle and if the fuel ignites it could cause a fire and explosion resulting in serious injury or death.

! CAUTION

Always use only a genuine Mazda fuel-filler cap or an approved equivalent, available at an Authorized Mazda Dealer. The wrong cap can result in a serious malfunction of the fuel and emission control systems. It may also cause the check engine light in the instrument cluster to illuminate.

▼ Fuel-Filler Lid

When the fuel-filler lid end is pressed with the doors unlocked, the fuel-filler lid rises. The fuel-filler lid operates in conjunction with the door locking/unlocking mechanism.

Make sure to lock both the doors when leaving the vehicle.

Refer to Door Locks on page 3-10.

To close, press the fuel-filler lid until a click sound is heard.

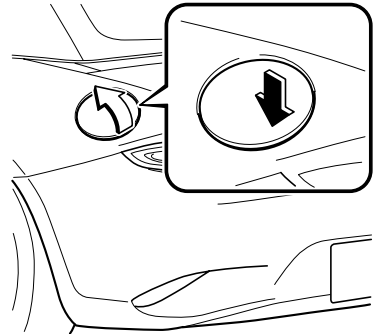

NOTE

Lock the doors after closing the fuel lid. If the fuel lid is closed after locking the doors, the fuel lid cannot be locked.

Fuel and Emission

▼ Fuel-Filler Cap

To remove the fuel-filler cap, turn it counterclockwise.

Attach the removed cap to the inner side of the fuel lid.

To close the fuel-filler cap, turn it clockwise until a click is heard.

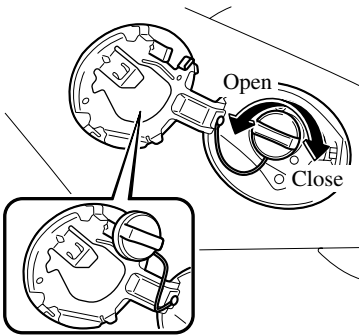

⚠ CAUTION

If the check fuel cap warning light illuminates, the fuel-filler cap may not be properly installed. If the warning light illuminates, park your vehicle safely off the right-of-way, remove the fuel-filler cap and reinstall it correctly. After the cap has been correctly installed, the fuel cap warning light may continue to illuminate until a number of driving cycles have been completed. A drive cycle consists of starting the engine (after four or more hours with the engine off) and driving the vehicle on city and highway roads. Continuing to drive with the check fuel cap warning light illuminated could cause the check engine light to illuminate as well.

Steering Wheel

! WARNING

Never adjust the steering wheel while the vehicle is moving:

Adjusting the steering wheel while the vehicle is moving is dangerous. Moving it can very easily cause the driver to abruptly turn to the left or right. This can lead to loss of control or an accident.

▼ Steering Wheel Adjustment

To change the angle of the steering wheel:

1. Stop the vehicle, and then pull down the lock release lever under the steering column.

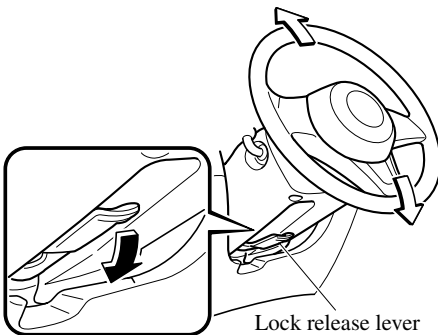

2. Tilt the steering wheel to the desired positions, then push the lever up to lock the column.
3. Attempt to push the steering wheel up and down to make sure it's locked before driving.

Mirrors

Mirrors

Before driving, adjust the inside and outside mirrors.

▼ Outside Mirrors

! WARNING

Be sure to look over your shoulder before changing lanes:

Changing lanes without taking into account the actual distance of the vehicle in the convex mirror is dangerous. You could have a serious accident. What you see in the convex mirror is closer than it appears.

Mirror type

Flat type (driver's side)

Flat surface mirror.

Convex type (passenger side)

The mirror has single curvature on its surface.

Power mirror adjustment

The ignition must be switched to ACC or ON position.

To adjust:

1. Rotate the mirror switch to the left **L** or right **R** to choose the left or right side mirror.

2. Press the mirror switch in the appropriate direction.

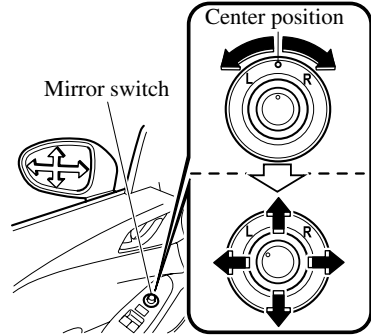

After adjusting the mirror, lock the control by rotating the switch in the center position.

Folding mirror

! WARNING

Always return the outside mirrors to the driving position before you start driving:

Driving with the outside mirrors folded in is dangerous. Your rear view will be restricted, and you could have an accident.

Manually fold the outside mirror rearward until it is flush with the vehicle.

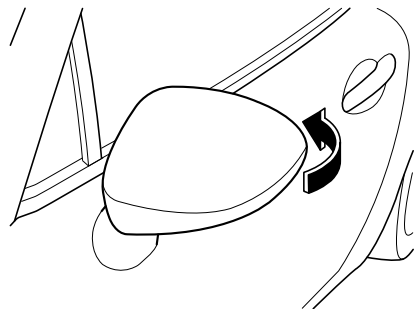

Driver's side auto-dimming door mirror

The movement of the auto-dimming door mirror is interlocked with the auto-dimming rearview mirror in the interior to automatically reduce glare from rear on-coming vehicles.

Refer to Rearview Mirror on page 3-29.

NOTE

The passenger-side door mirror does not have the auto-dimming feature.

▼ Rearview Mirror

! WARNING

Do not stack cargo or objects higher than the seatbacks:

Cargo stacked higher than the seatbacks is dangerous. It can block your view in the rearview mirror, which might cause you to hit another car when changing lanes.

Rearview mirror adjustment

Before driving, adjust the rearview mirror to center on the scene through the rear window.

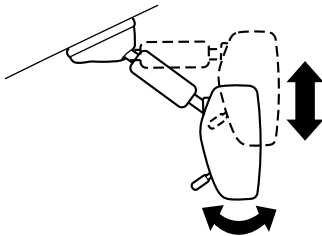

NOTE

For the manual day/night mirror, perform the adjustment with the day/night lever in the day position.

Reducing glare from headlights

Manual day/night mirror

Push the day/night lever forward for day driving. Pull it back to reduce glare of headlights from vehicles at the rear.

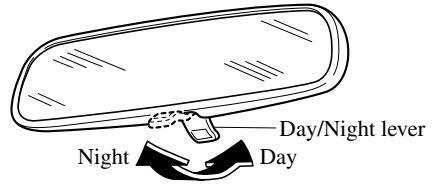

Auto-dimming mirror

The auto-dimming mirror automatically reduces the glare of headlights from vehicles at the rear when the ignition is switched ON.

Press the OFF button (○) to cancel the auto-dimming function. The indicator light will turn off.

To reactivate the auto-dimming function, press the ON button (I). The indicator light will illuminate.

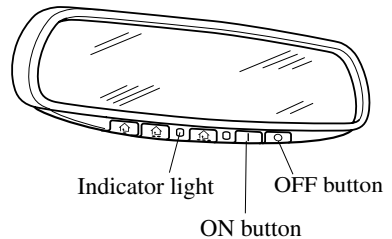

Mirrors

NOTE

- Do not use glass cleaner or suspend objects on or around the light sensor. Otherwise, light sensor sensitivity will be affected and may not operate normally.

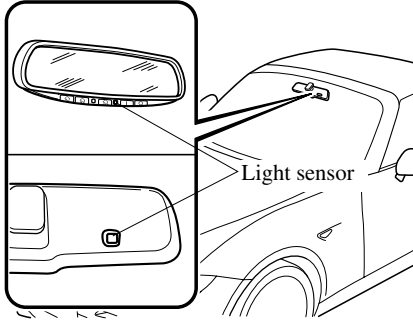

- For information regarding the 3 buttons (⬆️, ⬆️, ⬆️) on the auto-dimming mirror. Refer to HomeLink Wireless Control System on page 4-57.
- The auto-dimming function is canceled when the ignition is switched ON and the shift/selector lever is in reverse (R).

Power Windows

The ignition must be switched ON for the power windows to operate.

! WARNING

Make sure the opening is clear before closing a window:

Closing a power window is dangerous. A person's hands, head, or even neck could be caught by the window and result in serious injury or even death. This warning applies especially to children.

Never allow children to play with power window switches:

Power window switches that are not locked with the power window lock switch would allow children to operate power windows unintentionally, which could result in serious injury if a child's hands, head or neck becomes caught by the window.

! CAUTION

To prevent burning out the fuse and damaging the power window system, do not open or close both windows at once.

NOTE

A power window may no longer open/close if you continue to press the switch after opening/closing the power window. If the power window does not open/close, wait a moment and then operate the switch again.

▼ Operating the Power Windows

NOTE

- *The passenger window can be operated with each door switch when the power window lock switch on the driver's door is in the unlocked position (page 3-33).*
- *The passenger window can also be operated using the master control switches on the driver's door.*

Master control switches

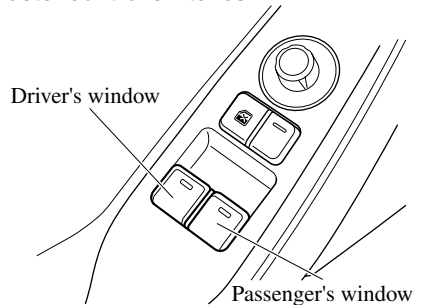

Windows

Normal opening/closing

To open the window to the desired position, lightly hold down the switch.

To close the window to the desired position, lightly pull up the switch.

Master control switches

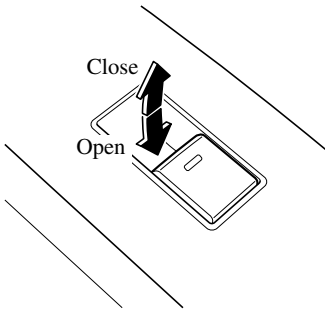
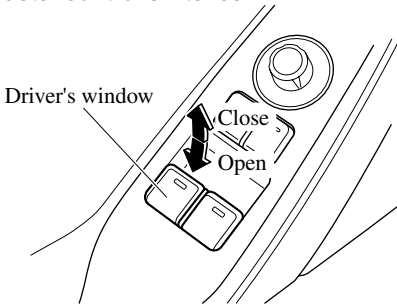

Auto-opening

To fully open the window automatically, press the switch completely down.

To stop the window partway, pull or press the switch in the opposite direction and then release it.

NOTE

The power window cannot be fully closed while the door is open.

Power window system initialization procedure

If the battery was disconnected during vehicle maintenance, or for other reasons (such as a switch continues to be operated after the window is open/closed), the window will not fully open automatically. Resetting of the automatic function can be performed using the master control switches or each passenger door switch. The power window auto function reset procedure can be done on both door switches. The power window auto function will only resume on the power window that has been reset.

1. Close the doors and the convertible top.
2. Switch the ignition ON.
3. Make sure that the power window lock switch located on the driver's door is not depressed.
4. Press the switch and fully open the window.
5. Pull up the switch to fully close the window and continue holding the switch for about 2 seconds after the window fully closed.
6. Repeat Steps 4-5 for the passenger power window while seated in the passenger seat.
7. Make sure that the power windows operate correctly using the door switches.

After the system has been re-initialized, passenger window can be fully opened automatically using the master control switches.

If the automatic power window operation does not operate normally while the doors or convertible top are opened/closed, reset it using the previous procedures.

Engine-off power window operation

The power window can be operated for about 40 seconds after the ignition is switched from ON to off with both doors closed. If any door is opened, the power window will stop operating.

NOTE

For engine-off operation of the power window, the switch must be held up firmly throughout window closure because the auto-closing function will be inoperable.

▼ Power Window Lock Switch

This feature prevents the passenger's power window from operating. Keep this switch in the locked position while children are in the vehicle.

Locked position (button depressed):

Only the driver's power window can be operated.

Unlocked position (button not depressed):

Both power windows on each door can be operated.

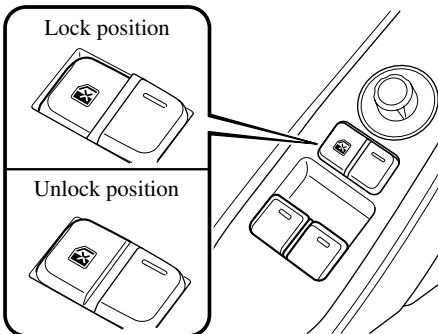

NOTE

When the power window lock switch is in the locked position, the light on the passenger power window switch turns off. The light may be difficult to see depending on the surrounding brightness.

Convertible Top (Soft Top)

Convertible Top (Soft Top)

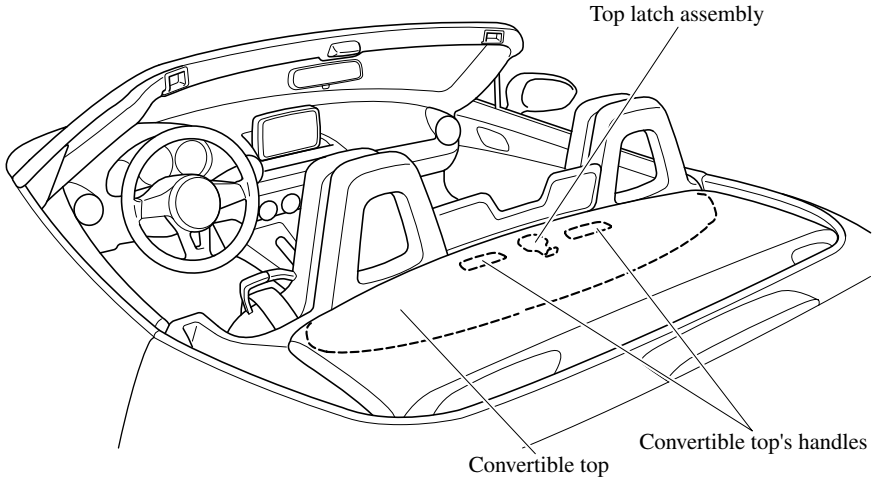

▼ Convertible Top Precautions

⚠ WARNING

Sit in the seat with the seat belt correctly fastened when the vehicle is moving:

Standing in the vehicle, or sitting on the convertible top storage area or center console when the vehicle is moving is a dangerous way to ride. During a sudden maneuver or collision you could be seriously injured or even killed.

Always keep your hands and fingers away from the fastening mechanisms when moving the convertible top:

It is dangerous to place your hands or fingers near the fastening mechanisms. Your hands or fingers could be caught and injured by the mechanism.

Convertible Top (Soft Top)

CAUTION

- Remove leaves or other matter that may accumulate on and around the convertible top. If leaves or other matter block the drain filter, water may enter the vehicle. Clean the drain filter at least once a year.
Refer to *Convertible Top Maintenance* on page 6-64.
- Before opening the convertible top, make sure the rear window defogger switch is turned off. Otherwise the heat generated from the defogger could damage the convertible top and the internal material.
- Before lowering or raising the convertible top, stop in a safe place off the right-of-way and park on a level surface.
- Make sure nothing is on the convertible top or near the back window when raising or lowering the convertible top.
Even small objects may interfere and cause damage.
- Do not drive through an automatic car wash; it may damage the convertible top.
- Do not raise or lower the convertible top when the temperature is below 5 °C (41 °F); this will damage the convertible top material.
- Do not lower the convertible top when it's wet. If the convertible top dries while folded, it will deteriorate and mold.
- Lowering the convertible top while it's wet can also cause water to drip into the passenger compartment.
- Do not raise or lower the convertible top in a strong wind as it could damage the convertible top or cause an unexpected accident.

NOTE

- The power windows go down automatically in conjunction with the convertible top opening/closing. However, this is a function for improving the operability, and it does not mean there is a problem. If the vehicle battery is disconnected for vehicle maintenance or other reasons, the power windows will not go down automatically. If the power windows do not go down, the automatic open/close mechanism for the windows must be reset.
Refer to *Operating the Power Windows* on page 3-31.
- The windblocker reduces the amount of wind coming into the cabin from behind when driving with the convertible top opened.
Refer to *Windblocker* on page 5-140.
- When lowering the convertible top, make sure objects inside the vehicle are not blown away by the wind.
- Secure all loose objects inside before driving with the convertible top down.
- To help prevent burglary or vandalism and to ensure that the passenger compartment stays dry, close the convertible top securely and lock both doors when leaving the vehicle.
- The soft top is made of high quality material and if it is not maintained correctly, the material could harden, become stained, or have an uneven gloss.

Convertible Top (Soft Top)

▼ Lowering the Convertible Top

⚠ CAUTION

Do not sit on the folded convertible top. Otherwise, the convertible top could be damaged or you may fall off and be injured.

1. Make sure the parking brake is applied.
2. If the engine is running, turn it off.
3. Make sure there are no objects which have been placed in the area where the convertible top is to be retracted.
4. With the lock release button depressed forward, pull back the top latch lever to unlock it.

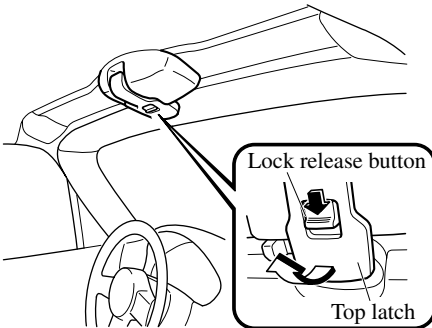

5. Remove the striker from the anchor.

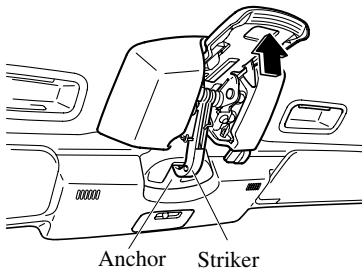

NOTE

If the power windows do not go down automatically, fully open the windows or open the doors.

6. Standing outside of the vehicle, hold the convertible top along the front edge and pull it toward the vehicle rear.

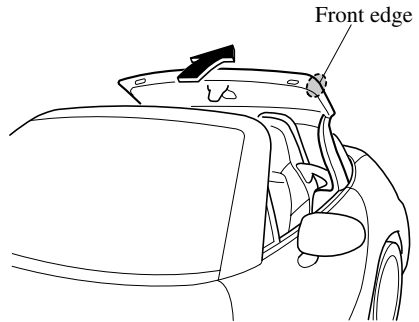

NOTE

To lower the convertible top from inside the vehicle, use the convertible top's handles.

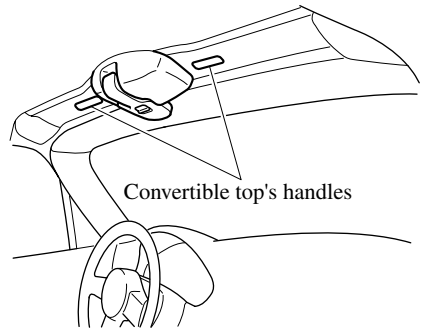

Convertible Top (Soft Top)

7. Move the convertible top rearward and fold it while pressing the rear glass lightly with your hand.

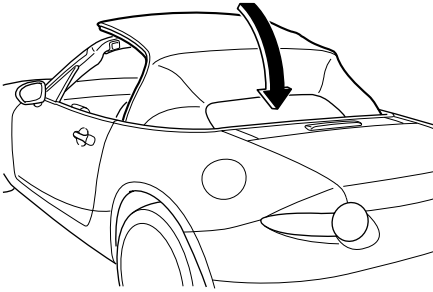

8. With the back end of the convertible top pressed, press the front end until a latch sound is heard. Lightly rock the retracted convertible top to make sure it is securely locked.

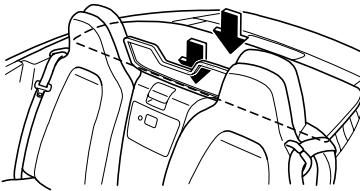

▼ Raising the Convertible Top

1. Make sure the parking brake is applied.
2. If the engine is running, turn it off.

3. Pull up the unlock lever to disengage the lock.

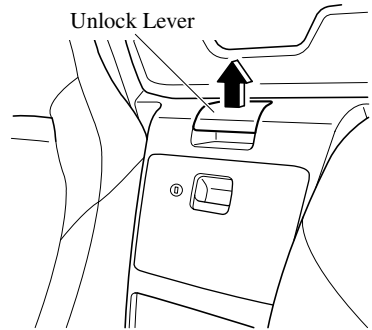

4. Standing outside of the vehicle, hold the convertible top along the front edge and pull it towards the vehicle front.

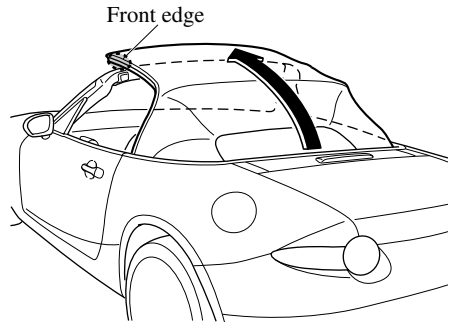

Convertible Top (Soft Top)

NOTE

- If the power windows do not go down automatically, fully open the windows or open the doors.
- To raise the convertible top from inside the vehicle, use the convertible top's handles.

Convertible top's handles

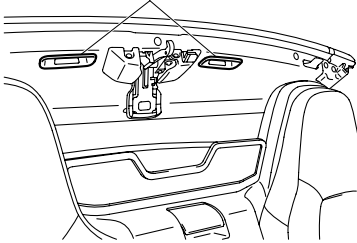

5. Sitting in a seat, grasp the convertible top's handles, and press the convertible top against the windshield. Make sure the striker engages with the anchor, move the top latch slowly, and then push the top latch upward until a latch sound is heard.

Convertible top's handles

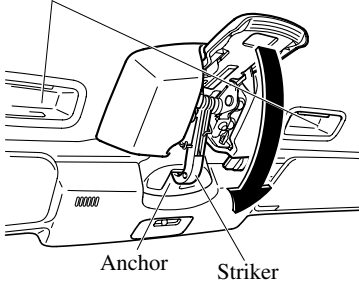

CAUTION

- Driving with the convertible top not fully locked could damage the convertible top. If the red indicator is visible on the lock release button, the convertible top is not locked. After locking the convertible top, verify that the red indicator is not visible.

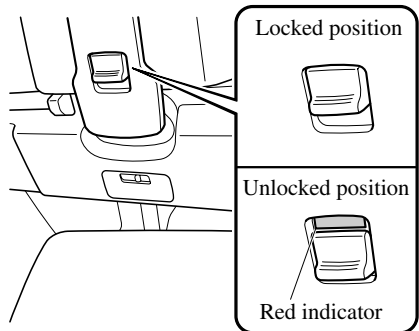

- Do not spray water directly near the seam of the window and convertible top when flushing away dirt on the soft top with water. Otherwise, water may enter the vehicle. Refer to Convertible Top Maintenance on page 6-64.

NOTE

- The convertible top may be constricted if it is left retracted for a long period. Therefore, if the top has become constricted, it may be difficult to hook the top latch striker to the anchor.
- Make sure the convertible top is securely locked by pushing up on it. If it still sounds loose (rattles) after being locked by the top latch, have it inspected at an Authorized Mazda Dealer.

Convertible Top (Retractable Fastback)

Convertible Top (Retractable Fastback)

The Retractable fastback opens/closes electrically by operating switches in the vehicle. When opening/closing the roof and window glass operate together. The front roof is stored in the storage area under rear roof.

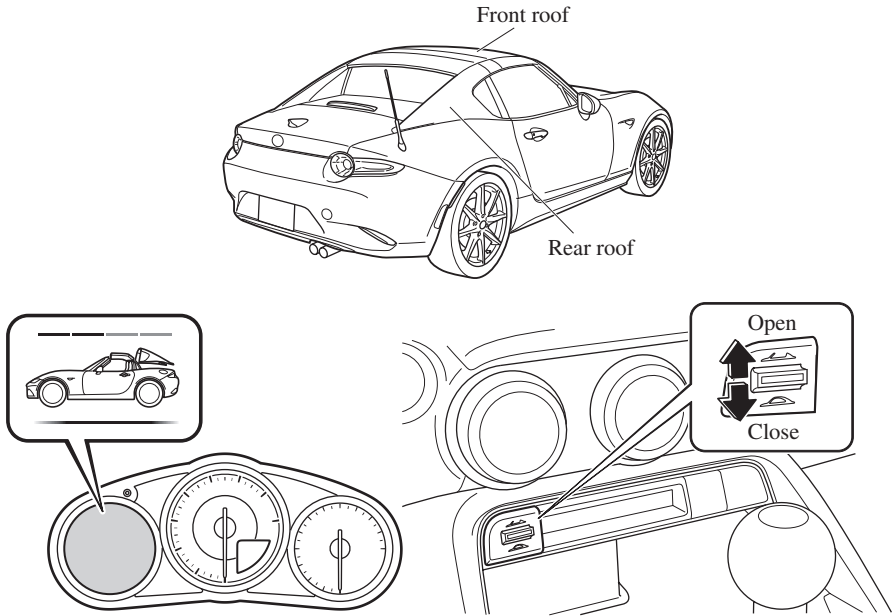

Convertible Top (Retractable Fastback)

▼ Retractable Fastback Precautions

WARNING

Always confirm that there are no people around the vehicle before operating the roof:

If the roof were to operate unexpectedly, it could result in an accident and serious injury from someone getting caught in the mechanism.

Sit in the seat with the seat belt correctly fastened when the vehicle is moving:

Standing in the vehicle, or sitting on the rear roof or center console when the vehicle is moving is a dangerous way to ride. During a sudden maneuver or collision you could be seriously injured or even killed.

Always keep your hands and fingers away from the fastening mechanisms when moving the roof:

It is dangerous to place your hands or fingers near the fastening mechanisms. Your hands or fingers could be caught and injured by the mechanism.

Convertible Top (Retractable Fastback)

CAUTION

- *When getting in or out of the vehicle with the roof open, be careful not to hit your head or body on the corner of the windshield glass. It may cause an injury.*
- *Do not drive with the roof partially opened; this could damage the roof or cause an unexpected accident.*
- *Children should not be allowed to play with the retractable fastback switch.*
- *Do not place objects or cargo around the rear roof, rear glass, or the front roof storage area. Even small objects may interfere and cause damage.*
- *Remove leaves that accumulate on and around the roof. If the leaves are not removed, they may block the water drainage outlets.*
- *Before opening the roof, make sure the rear window defogger switch (Defroster) is turned off. Otherwise the heat generated from the defogger could damage the roof and the internal material.*
- *When opening/closing the roof, verify that there is no obstruction above the roof (about 1.6 m (5 ft 2 in) from the ground) so as not to damage the roof or the obstruction.*
- *When opening/closing the roof, do not apply any load to the front roof or the rear roof. The opening/closing mechanism of the roof may be damaged.*
- *Do not spray water directly near the seam of the window and roof when washing off dirt on the roof with water. Otherwise, water may enter the cabin. Refer to Retractable Fastback Maintenance on page 6-66.*
- *Open/close the roof with the vehicle parked on a hard, level ground in a safe place where the vehicle does not obstruct traffic. If the roof is opened/closed on a slope or bump, the opening/closing mechanism of the roof may be damaged.*
- *Do not drive through an automatic car wash as it may damage the roof.*
- *Do not open or close the roof forcefully when the ambient temperature is low and the roof or the surrounding area is frozen as it could damage the roof.*
- *Opening the roof while it is wet can also cause water to drip into the passenger compartment.*
- *Do not open or close the roof in a strong wind as it could damage the roof.*

Convertible Top (Retractable Fastback)

NOTE

- *When opening the roof, make sure objects inside the vehicle are not blown away by the wind.*
- *Secure all loose objects inside before driving with the roof down.*
- *To help prevent burglary or vandalism and to ensure that the passenger compartment stays dry, close the roof securely and lock both doors when leaving the vehicle.*
- *The power windows lower automatically in conjunction with the roof opening/closing. This is a function for improving the operability and it does not indicate a problem. If the vehicle battery is disconnected for vehicle maintenance or other reasons, the power windows will not lower automatically. If the power windows do not lower, reset the power window automatic open/close function. Refer to Operating the Power Windows on page 3-31.*
- *The windblocker reduces the amount of wind coming into the cabin from behind when driving with the roof opened. Refer to Windblocker on page 5-140.*

▼ **Operation Indication**

Operation Indicator Light

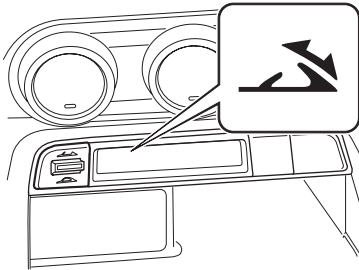

When illuminated

This indicates that the roof is only partially open.

When flashing

This indicates that the roof is being open/closed. (During switch operation)

When not illuminated

This indicates that the roof is open/closed fully.

NOTE

If the operation indicator light flashes quickly, there may be a system malfunction. Consult an Authorized Mazda Dealer.

Convertible Top (Retractable Fastback)

Roof operation display

The roof operation status is indicated on the multi-information display. The following table shows display examples when opening the roof:

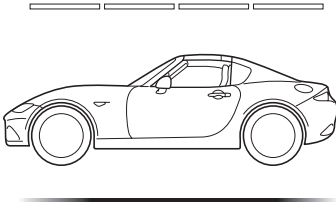
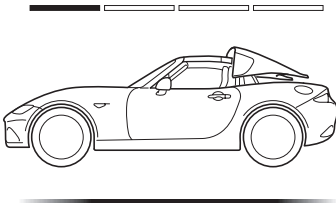
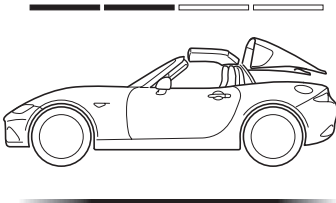
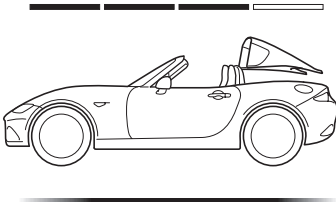
Operation	Roof status	Indication
Before operation	Roof closed	
During operation	Rear roof opened	
	Rear roof opened Front roof opened	
	Rear roof opened Front roof stored	

Convertible Top (Retractable Fastback)

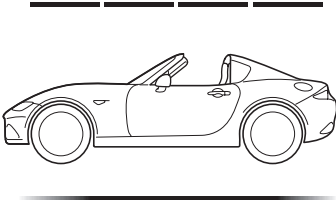
Operation	Roof status	Indication
Operation complete	Rear roof closed	

▼ Operation Conditions

If the following conditions have been satisfied, the roof can be opened/closed.

- The ignition is switched ON.
- Shift/selector lever is in a position other than R (reverse).
- Vehicle speed is 10 km/h (6.2 mph) or less.
- The trunk lid is closed.

CAUTION

If the vehicle speed exceeds 10 km/h (6.2 mph) during the opening/closing operation, the opening/closing operation of the roof stops midstream. If the roof stops midstream, visibility at the rear may be impaired or damage to the roof may occur which could lead to an accident. Operate the switch again with the vehicle stopped, depending on the road and traffic conditions, to complete opening/closing operation of the roof.

NOTE

If the roof cannot be closed even after the operation conditions are all met, have it checked at an Authorized Mazda Dealer. The roof can be closed manually as an emergency measure. Refer to When the Roof Cannot be Closed on page 7-57.

Convertible Top (Retractable Fastback)

▼ Opening the Roof

1. Park on a hard, level surface off the right-of-way and firmly set the parking brake.
2. Put a vehicle with an automatic transmission in Park (P), a manual transmission in Neutral.
3. Apply the parking brake with the brake pedal depressed.
4. Start the Engine.

NOTE

Do not open/close the roof with the engine stopped. Otherwise the vehicle's battery power could be depleted.

5. Continue pressing the retractable fastback switch in the open direction until the roof is completely open.

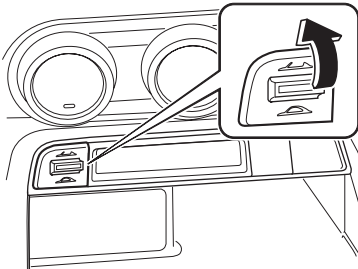

NOTE

- *If the retractable fastback switch is pressed in the open direction, a warning beep sounds.*
- *If the windows are closed, the windows automatically open partially when the rear roof opens.*
After the rear roof is opened and the retractable fastback switch is continuously pressed in the open direction, the power windows close completely.
Once you remove your hand from the switch, the power windows do not close even if it is operated again. If this happens, completely close the power windows using the power window switch.
- *The roof keeps opening and the operation indicator light flashes while the retractable fastback switch is pressed in the open direction.*
- *If the switch is released while the roof is opening, the roof stops opening. If the switch is pressed in the open direction again, the roof resumes opening.*
- *When the operation is finished, a beep sound is heard and the operation indicator light turns off.*
- *When the roof is half-open, the front roof resumes opening after the rear roof is completely open.*

▼ Closing the Roof

1. Park on a hard, level surface off the right-of-way and firmly set the parking brake.
2. Put a vehicle with an automatic transmission in Park (P), a manual transmission in Neutral.
3. Apply the parking brake with the brake pedal depressed.
4. Start the Engine.

Convertible Top (Retractable Fastback)

NOTE

Do not open/close the roof with the engine stopped. Otherwise the vehicle's battery power could be depleted.

5. Slightly slide the seats back if they are in the foremost position.
6. Continue pressing the retractable fastback switch in the close direction until the rear roof is completely closed.

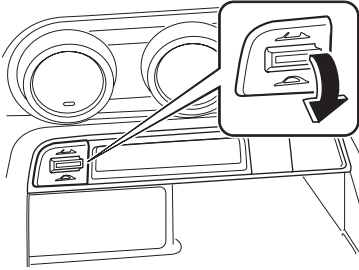

NOTE

- *If the retractable fastback switch is pressed in the close direction, a warning beep sounds.*
- *If the windows are closed, the windows automatically open partially when the rear roof opens.*
- *The roof keeps closing and the operation indicator light flashes while the retractable fastback switch is pressed in the close direction.*
- *If the switch is released while the roof is closing, the roof stops closing. If the switch is pressed in the close direction again, the roof resumes closing.*
- *When the operation is finished, a beep sound is heard and the operation indicator light turns off.*

Modification and Add-On Equipment

Mazda cannot guarantee the immobilizer and the theft-deterrent systems' operation if the system has been modified or if any add-on equipment has been installed.

CAUTION

To avoid damage to the vehicle, do not modify the system or install any add-on equipment to the immobilizer and the theft-deterrent systems or the vehicle.

Immobilizer System

The immobilizer system allows the engine to start only with a key the system recognizes.

If someone attempts to start the engine with an unrecognized key, the engine will not start, thereby helping to prevent vehicle theft.

If you have a problem with the immobilizer system or the key, consult an Authorized Mazda Dealer.

CAUTION

- *Radio equipment like this is governed by laws in the United States. Changes or modifications not expressly approved by the party responsible for compliance could void the user's authority to operate the equipment.*
- *To avoid damage to the key, do not:*
 - *Drop the key.*
 - *Get the key wet.*
 - *Expose the key to any kind of magnetic field.*
 - *Expose the key to high temperatures on places such as the dashboard or hood, under direct sunlight.*
- *If the engine does not start with the correct key, and the security indicator light keeps illuminating or flashing, the system may have a malfunction. Consult an Authorized Mazda Dealer.*

Security System

NOTE

- *The keys carry a unique electronic code. For this reason, and to assure your safety, obtaining a replacement key requires some waiting time. They are only available through an Authorized Mazda Dealer.*
- *Always keep a spare key in case one is lost. If a key is lost, consult an Authorized Mazda Dealer as soon as possible.*
- *If you lose a key, an Authorized Mazda Dealer will reset the electronic codes of your remaining keys and immobilizer system. Bring all the remaining keys to an Authorized Mazda Dealer to reset. Starting the vehicle with a key that has not been reset is not possible.*

▼ Operation

NOTE

- *The engine may not start and security indicator light may illuminate or flash if the key is placed in an area where it is difficult for the system to detect the signal, such as on the dashboard. Move the key to a location within the signal range, switch the ignition off, and then restart the engine.*
- *Signals from a TV or radio station, or from a transceiver or mobile telephone could interfere with your immobilizer system. If you are using the proper key and the engine fails to start, check the security indicator light.*

Arming

The system is armed when the ignition is switched from ON to off.

The security indicator light in the instrument cluster flashes every 2 seconds until the system is disarmed.



Disarming

The system is disarmed when the ignition is switched ON with the correct programmed key. The security indicator light illuminates for about 3 seconds and then turns off. If the engine does not start with the correct key, and the security indicator light remains illuminated or flashing, try the following:

Make sure the key is within the operational range for signal transmission. Switch the ignition off, and then restart the engine. If the engine does not start after 3 or more tries, contact an Authorized Mazda Dealer.

NOTE

- *If the security indicator light flashes continuously while you are driving, do not shut off the engine. Go to an Authorized Mazda Dealer and have it checked. If the engine is shut off while the indicator light is flashing, you will not be able to restart it.*
- *Because the electronic codes are reset when the immobilizer system is repaired, the keys are needed. Make sure to bring all the keys to an Authorized Mazda Dealer so that they can be programmed.*

Theft-Deterrent System*

If the theft-deterrent system detects an inappropriate entry into the vehicle, which could result in the vehicle or its contents being stolen, the alarm alerts the surrounding area of an abnormality by sounding the horn and flashing the hazard warning lights.

The system will not function unless it's properly armed. So when you leave the vehicle, follow the arming procedure correctly.

▼ Operation

System triggering conditions

The horn sounds intermittently and the hazard warning lights flash for about 30 seconds when the system is triggered by any one of the following:

- Unlocking a door with the key, door lock switch, or an inside door-lock knob.
- Forcing open a door, the hood or the trunk lid.
- Opening the hood by operating the hood release handle.
- Switching the ignition ON without using the push button start.

If the system is triggered again, the lights and horn will activate until the driver's door is unlocked with the transmitter.

(With the advanced keyless function)

The lights and horn can also be deactivated by pressing the request switch on a door.

NOTE

- *The trunk lid does not open while the theft-deterrent system is operating.*
- *If the battery goes dead while the theft-deterrent system is armed, the horn will activate and the hazard warning lights will flash when the battery is charged or replaced.*

▼ How to Arm the System

1. Close the windows and the convertible top securely.
2. Switch the ignition OFF.
3. Make sure the hood, the doors, and the trunk lid are closed.
4. Press the lock button on the transmitter or lock the driver's door from the outside with the auxiliary key. The hazard warning lights will flash once.

The following method will also arm the theft-deterrent system:

Press the door-lock switch “” while any door is open and then close both of the doors.

(With the advanced keyless function)

Press a request switch.

The security indicator light in the instrument cluster flashes twice per second for 20 seconds.



5. After 20 seconds, the system is fully armed.

Security System

NOTE

- *The theft-deterrent system can also be armed by activating the auto relock function with both the doors, the trunk lid and the hood closed. Refer to Transmitter on page 3-4.*
- *The system will disarm if one of the following operations takes place within 20 seconds after pressing the lock button:*
 - *Unlocking any door.*
 - *Opening any door.*
 - *Opening the hood.*
 - *Switching the ignition ON.*

To rearm the system, do the arming procedure again.

- *When the doors are locked by pressing the lock button on the transmitter or using the auxiliary key while the theft-deterrent system is armed, the hazard warning lights will flash once to indicate that the system is armed.*

▼ To Turn Off an Armed System

An armed system can be turned off using any one of the following methods:

- Pressing the unlock button on the transmitter.
- Starting the engine with the push button start.
- **(With the advanced keyless function)**
 - Pressing a request switch on the doors.

The hazard warning lights will flash twice.

NOTE

When the doors are unlocked by pressing the unlock button on the transmitter while the theft-deterrent system is turned off, the hazard warning lights will flash twice to indicate that the system is turned off.

▼ To Stop the Alarm

A triggered alarm can be turned off using any one of the following methods:

- Pressing the unlock button on the transmitter.
- Starting the engine with the push button start.
- **(With the advanced keyless function)**
 - Pressing a request switch on the doors.
 - Pressing the electric trunk lid opener while the key is being carried.

The hazard warning lights will flash twice.

▼ Theft-Deterrent Labels



A label indicating that your vehicle is equipped with a Theft-Deterrent System is in the console box.

Mazda recommends that you affix it to the lower rear corner of a front door window.

Break-In Period

No special break-in is necessary, but a few precautions in the first 1,000 km (600 miles) may add to the performance, economy, and life of the vehicle.

- Do not race the engine.
- Do not maintain one constant speed, either slow or fast, for a long period of time.
- Do not drive constantly at full-throttle or high engine rpm for extended periods of time.
- Avoid unnecessary hard stops.
- Avoid full-throttle starts.

Saving Fuel and Protection of the Environment

How you operate your Mazda determines how far it will travel on a tank of fuel. Use these suggestions to help save fuel and reduce CO₂.

- Avoid long warm-ups. Once the engine runs smoothly, begin driving.
- Avoid fast starts.
- Drive at lower speeds.
- Anticipate when to apply the brakes (avoid sudden braking).
- Follow the maintenance schedule (page 6-4) and have an Authorized Mazda Dealer perform inspections and servicing.
- Use the air conditioner only when necessary.
- Slow down on rough roads.
- Keep the tires properly inflated.
- Do not carry unnecessary weight.
- Do not rest your foot on the brake pedal while driving.
- Keep the wheels in correct alignment.
- Keep windows closed at high speeds.
- Slow down when driving in crosswinds and headwinds.

WARNING

Never stop the engine when going down a hill:

Stopping the engine when going down a hill is dangerous. This causes the loss of power steering and power brake control, and may cause damage to the drivetrain. Any loss of steering or braking control could cause an accident.

Hazardous Driving

! WARNING

Be extremely careful if it is necessary to downshift on slippery surfaces:

Downshifting into lower gear while driving on slippery surfaces is dangerous. The sudden change in tire speed could cause the tires to skid. This could lead to loss of vehicle control and an accident.

When driving on ice or in water, snow, mud, sand, or similar hazards:

- Be cautious and allow extra distance for braking.
- Avoid sudden braking and sudden maneuvering.
- Do not pump the brakes. Continue to press down on the brake pedal. Refer to Antilock Brake System (ABS) on page 4-65.
- If you get stuck, select a lower gear and accelerate slowly. Do not spin the rear wheels.
- For more traction in starting on slippery surfaces such as ice or packed snow, use sand, rock salt, chains, carpeting, or other nonslip material under the rear wheels.

NOTE

Use snow chains only on the rear wheels.

Floor Mat

We recommend the use of Genuine Mazda floor mats.

! WARNING

Make sure the floor mats are hooked on the retention pins to prevent them from bunching up under the foot pedals:

Using a floor mat that is not secured is dangerous as it will interfere with the accelerator and brake pedal operation, which could result in an accident.

Do not install two floor mats, one on top of the other, on the driver's side:

Installing two floor mats, one on top of the other, on the driver's side is dangerous as the retention pins can only keep one floor mat from sliding forward.

Loose floor mat(s) will interfere with the foot pedal and could result in an accident.

If using an all weather mat for winter use always remove the original floor mat.

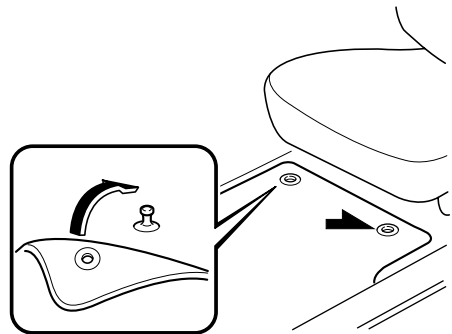

When setting a floor mat, position the floor mat so that its grommets are inserted over the pointed end of the retention posts.

Rocking the Vehicle

WARNING

Do not spin the wheels at more than 56 km/h (35 mph), and do not allow anyone to stand behind a wheel when pushing the vehicle:

When the vehicle is stuck, spinning the wheels at high speed is dangerous. The spinning tire could overheat and explode. This could cause serious injuries.

CAUTION

Too much rocking may cause engine overheating, transmission failure, and tire damage.

If you must rock the vehicle to free it from snow, sand or mud, depress the accelerator slightly and slowly move the shift lever from 1 (D) to R.

Winter Driving

Carry emergency gear, including tire chains, window scraper, flares, a small shovel, jumper cables, and a small bag of sand or salt.

Ask an Authorized Mazda Dealer to check the following:

- Have the proper ratio of antifreeze in the radiator.
Refer to Engine Coolant on page 6-29.
- Inspect the battery and its cables. Cold reduces battery capacity.
- Use an engine oil appropriate for the lowest ambient temperatures that the vehicle will be driven in (page 6-27).
- Inspect the ignition system for damage and loose connections.
- Use washer fluid made with antifreeze—but do not use engine coolant antifreeze for washer fluid (page 6-31).

NOTE

- *Do not use the parking brake in freezing weather as it may freeze. Instead, shift to P with an automatic transmission and to 1 or R with a manual transmission. Block the rear wheels.*
- *Remove snow before driving. Snow left on the windshield is dangerous as it could obstruct vision.*
- *Do not open or close the soft top when the temperature is 5 °C (41 °F) or less. The material of the soft top could be damaged by freezing.*
- *Do not apply excessive force to a window scraper when removing ice or frozen snow on the mirror glass and windshield.*
- *Never use warm or hot water for removing snow or ice from windows and mirrors as it could result in the glass cracking.*

Driving Tips

- *Drive slowly. Braking performance can be adversely affected if snow or ice adheres to the brake components. If this situation occurs, drive the vehicle slowly, releasing the accelerator pedal and lightly applying the brakes several times until the brake performance returns to normal.*

▼ Snow Tires

Use snow tires on all four wheels

Do not go faster than 120 km/h (75 mph) while driving with snow tires. Inflate snow tires 30 kPa (0.3 kgf/cm², 4.3 psi) more than recommended on the tire pressure label (driver's door frame), but never more than the maximum cold-tire pressure shown on the tires.

The vehicle is originally equipped with summer tires designed for optimum traction on wet and dry roads. If your vehicle is to be used on snow and ice covered roads, Mazda recommends that you replace the tires originally equipped on your vehicle with snow tires during the winter months.

WARNING

Use only the same size and type tires (snow, radial, or non-radial) on all four wheels:

Using tires different in size or type is dangerous. Your vehicle's handling could be greatly affected and result in an accident.

CAUTION

Check local regulations before using studded tires.

▼ Tire Chains

Check local regulations before using tire chains.

CAUTION

- *Chains may affect handling.*
- *Do not go faster than 50 km/h (30 mph) or the chain manufacturer's recommended limit, whichever is lower.*
- *Drive carefully and avoid bumps, holes, and sharp turns.*
- *Avoid locked-wheel braking.*
- *Do not use chains on roads that are free of snow or ice. The tires and chains could be damaged.*
- *Chains may scratch or chip aluminum wheels.*

NOTE

If your vehicle is equipped with the tire pressure monitoring system, the system may not function correctly when using tire chains.

Install the chains on the rear tires only. Do not use chains on the front tires. Please consult an Authorized Mazda Dealer.

Installing the chains

1. Secure the chains on the rear tires as tightly as possible. Always follow the chain manufacturer's instructions.
2. Retighten the chains after driving 1/2—1 km (1/4—1/2 mile).

Driving In Flooded Area

WARNING

Dry off brakes that have become wet by driving slowly, releasing the accelerator pedal and lightly applying the brakes several times until the brake performance returns to normal:

Driving with wet brakes is dangerous. Increased stopping distance or the vehicle pulling to one side when braking could result in a serious accident. Light braking will indicate whether the brakes have been affected.

CAUTION

Do not drive the vehicle on flooded roads as it could cause short circuiting of electrical/electronic parts, or engine damage or stalling from water absorption. If the vehicle has been immersed in water, consult an Authorized Mazda Dealer.

Overloading

WARNING

Be careful not to overload your vehicle:
The gross axle weight rating (GAWR) and the gross vehicle weight rating (GVWR) of the vehicle are on the Motor Vehicle Safety Standard Label on the driver's door frame. Exceeding these ratings can cause an accident or vehicle damage. You can estimate the weight of the load by weighing the items (or people) before putting them in the vehicle.

Driving on Uneven Road

Your vehicle's suspension and underbody can be damaged if driven on rough/uneven roads or over speed bumps at excessive speeds. Use care and reduce speed when traveling on rough/uneven roads or over speed bumps.

Use care not to damage the vehicle's underbody, bumpers or muffler(s) when driving under the following conditions:

- Ascending or descending a slope with a sharp transition angle
- Ascending or descending a driveway or trailer ramp with a sharp transition angle

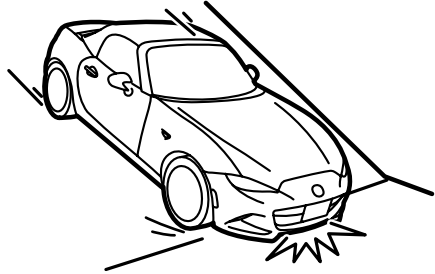

This vehicle is equipped with low profile tires allowing class-leading performance and handling. As a result, the sidewall of the tires are very thin and the tires and wheels can be damaged if driven through potholes or on rough/uneven roads at excessive speeds. Use care and reduce speed when traveling on rough/uneven roads or through potholes.

Trailer Towing

Your Mazda is not designed for towing.
Never tow a trailer with your Mazda.

Recreational Towing

An example of "recreational towing" is towing your vehicle behind a motorhome. The transmission is not designed for towing this vehicle on all 4 wheels. When doing recreational towing refer to "Towing Description" (page 7-30) and "Tiedown Hooks" (page 7-31) and carefully follow the instructions.

MEMO

4

When Driving

Information concerning safe driving and stopping.

Start/Stop Engine	4-4	ABS/TCS/DSC	4-65
Ignition Switch.....	4-4	Antilock Brake System (ABS).....	4-65
Starting the Engine.....	4-5	Traction Control System (TCS) ...	4-66
Turning the Engine Off	4-10	Dynamic Stability Control (DSC) ...	4-67
Instrument Cluster and Display	4-11	Fuel Economy Monitor	4-69
Meters and Gauges.....	4-11	Fuel Economy Monitor*	4-69
Multi-information Display and INFO		Drive Selection	4-71
Switch*	4-18	Drive Selection*	4-71
Warning/Indicator Lights	4-26	Power Steering	4-73
Transmission	4-31	Power Steering	4-73
Manual Transmission		i-ACTIVSENSE	4-74
Operation.....	4-31	i-ACTIVSENSE*	4-74
Automatic Transmission		Adaptive Front Lighting System	
Controls.....	4-34	(AFS)*	4-75
Switches and Controls	4-45	High Beam Control System	
Lighting Control.....	4-45	(HBC)*	4-76
Turn and Lane-Change Signals....	4-50	Lane Departure Warning System	
Windshield Wipers and Washer ...	4-51	(LDWS)*	4-79
Rear Window Defogger	4-55	Blind Spot Monitoring (BSM)	
Horn	4-56	System*	4-85
Hazard Warning Flasher.....	4-57	Rear Cross Traffic Alert	
HomeLink Wireless Control		(RCTA)*	4-92
System*	4-57	Forward Sensing Camera	
Brake	4-61	(FSC)*	4-95
Brake System	4-61	Radar Sensors (Rear)*	4-98
Hill Launch Assist (HLA)*	4-63	Cruise Control	4-100
		Cruise Control*	4-100

Tire Pressure Monitoring System... 4-105
Tire Pressure Monitoring
System* 4-105

MEMO

Start/Stop Engine

Ignition Switch

▼ Push Button Start Positions

The system operates only when the key is within operational range.

Each time the push button start is pressed, the ignition switches in the order of off, ACC, and ON. Pressing the push button start again from ON switches the ignition off.

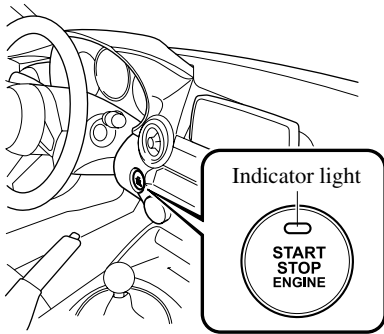

NOTE

- The engine starts by pressing the push button start while depressing the clutch pedal (manual transmission) or the brake pedal (automatic transmission). To switch the ignition position, press the push button start without depressing the pedal.
- Do not leave the ignition switched ON while the engine is not running. Doing so could result in the battery going dead. If the ignition is left in ACC (For automatic transmission, the selector lever is in the P position, and the ignition is in ACC), the ignition switches off automatically after about 25 minutes.

Off

The power supply to electrical devices turns off and the push button start indicator light (amber) also turns off.

In this position the steering wheel is locked.

! WARNING

Before leaving the driver's seat, always switch the ignition off, set the parking brake, and make sure the selector lever is in P (automatic transmission) or in 1st gear or R (manual transmission):

Leaving the driver's seat without switching the ignition off, setting the parking brake, and shifting the selector lever to P (automatic transmission) or to 1st gear or R (manual transmission) is dangerous. Unexpected vehicle movement could occur which could result in an accident.

In addition, if your intention is to leave the vehicle for even a short period, it is important to switch the ignition off, as leaving it in another position will disable some of the vehicle's security systems and run the battery down.

ACC (Accessory)

Some electrical accessories will operate and the indicator light (amber) illuminates.

NOTE

The keyless entry system does not function while the push button start has been pressed to ACC, and the doors will not lock/unlock even if they have been locked manually.

ON

This is the normal running position after the engine is started. The indicator light (amber) turns off. (The indicator light (amber) illuminates when the ignition is switched ON and the engine is not running.)

Some indicator lights/warning lights should be inspected before the engine is started (page 4-18).

NOTE

When the push button start is pressed to ON, the sound of the fuel pump motor operating near the fuel tank can be heard. This does not indicate an abnormality.

Starting the Engine** WARNING****Radio waves from the key may affect medical devices such as pacemakers:**

Before using the key near people who use medical devices, ask the medical device manufacturer or your physician if radio waves from the key will affect the device.

NOTE

- *The key must be carried because the key carries an immobilizer chip that must communicate with the engine controls at short range.*
- *The engine can be started when the push button start is pressed from off, ACC, or ON.*
- *The push button start system functions (function which can start the engine by only carrying the key) can be deactivated to prevent any possible adverse effect on a user wearing a pacemaker or other medical device. If the system is deactivated, you will be unable to start the engine by carrying the key. Consult an Authorized Mazda Dealer for details. If the push button start system functions have been deactivated, you can start the engine by following the procedure indicated when the key battery goes dead. Refer to Engine Start Function When Key Battery is Dead on page 4-8.*

Start/Stop Engine

- After starting a cold engine, the engine speed increases and a whining sound from the engine compartment can be heard.

This is for improved exhaust gas purification and does not indicate any parts defect.

- Engine-starting is controlled by the spark ignition system.

This system meets all Canadian Interference-Causing Equipment Standard requirements regulating the impulse electrical field strength of radio noise.

1. Make sure you are carrying the key.
2. Occupants should fasten their seat belts.
3. Make sure the parking brake is on.
4. Continue to press the brake pedal firmly until the engine has completely started.
5. **(Manual transmission)**
Continue to press the clutch pedal firmly until the engine has completely started.

(Automatic transmission)

Put the vehicle in park (P). If you must restart the engine while the vehicle is moving, shift into neutral (N).

NOTE

(Manual transmission)

The starter will not operate if the clutch pedal is not depressed sufficiently.

(Automatic transmission)

The starter will not operate if the selector lever is not in P or N and the brake pedal is not depressed sufficiently.

6. Verify that the KEY indicator light (green) in the instrument cluster and the push button start indicator light (green) illuminate.

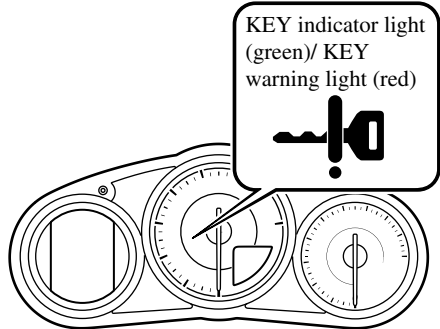
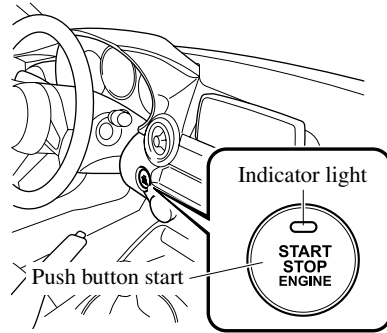

NOTE

- If the push button start indicator light (green) flashes, make sure that the key is being carried.
- If the push button start indicator light (green) flashes with the key being carried, touch the key to the push button start and start the engine. Refer to Engine Start Function When Key Battery is Dead on page 4-8.

⚠ CAUTION

If the KEY warning light (red) illuminates, or the push button start indicator light (amber) flashes, this could indicate a problem with the engine starting system. This may prevent the engine from starting or from switching the ignition to ACC or ON. Have your vehicle inspected at an Authorized Mazda Dealer as soon as possible.

NOTE

- Under the following conditions, the KEY warning light (red) flashes after the push button start is pressed. This informs the driver that the push button start will not switch to ACC even if it is pressed from off.
 - The key battery is dead.
 - The key is out of operational range.
 - The key is placed in areas where it is difficult for the system to detect the signal (page 3-7).
 - A key from another manufacturer similar to the key is in the operational range.
 - **(Forced engine starting method)**
If the KEY warning light (red) illuminates, or the push button start indicator light (amber) flashes, this could indicate that the engine may not start using the usual starting method. Have your vehicle inspected at an Authorized Mazda Dealer as soon as possible. If this occurs, the engine can be force-started. Press and hold the push button start until the engine starts. Other procedures necessary for starting the engine, such as having the key in the cabin, and depressing the clutch pedal (manual transmission) or the brake pedal (automatic transmission) are required.
 - When the engine is force-started, the KEY warning light (red) remains illuminated and the push button start indicator light (amber) remains flashing.
 - **(Automatic transmission)**
When the selector lever is in the neutral (N) position, the KEY indicator light (green) and the push button start indicator light (green) do not illuminate.
7. Press the push button start after both the KEY indicator light (green) in the instrument cluster and the push button start indicator light (green) illuminate.

NOTE

- After starting the engine, the push button start indicator light (amber) turns off and the ignition switches to the ON position.
- After pressing the push button start and before the engine starts, the operation sound of the fuel pump motor from near the fuel tank can be heard, however, this does not indicate a malfunction.

Start/Stop Engine

8. After starting the engine, let it idle for about ten seconds.

NOTE

- *Whether the engine is cold or warm, it should be started without the use of the accelerator.*
- *If the engine does not start the first time, refer to Starting a Flooded Engine under Emergency Starting. If the engine still does not start, have your vehicle inspected by an Authorized Mazda Dealer (page 7-26).*

▼ Engine Start Function When Key Battery is Dead

CAUTION

When starting the engine by holding the transmitter over the push button start due to a dead key battery or a malfunctioning key, be careful not to allow the following, otherwise the signal from the key will not be received correctly and the engine may not start.

- *Metal parts of other keys or metal objects touch the key.*



- *Spare keys or keys for other vehicles equipped with an immobilizer system touch or come near the key.*



- *Devices for electronic purchases, or security passage touch or come near the key.*

If the engine cannot be started due to a dead key battery, the engine can be started using the following procedure:

1. Continue to depress the brake pedal firmly until the engine has completely started.
2. **(Manual transmission)** Continue to depress the clutch pedal firmly until the engine has completely started.
3. Verify that the push button start indication light (green) flashes.
4. Touch the push button start using the backside of the key (as shown) while the push button start indicator light (green) flashes.

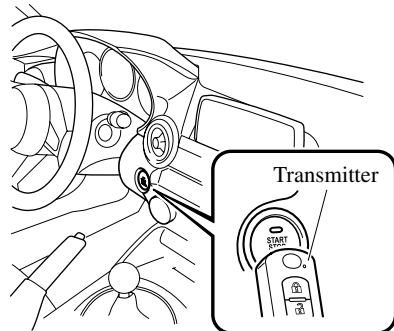

NOTE

When touching the push button start using the backside of the key as shown in the illustration, touch the push button start with the lock switch side of the key facing up.

5. Verify that the push button start indicator light (green) turns on.
6. Press the push button start to start the engine.

NOTE

- *The engine cannot be started unless the clutch pedal is fully depressed (manual transmission) or the brake pedal is fully depressed (automatic transmission).*
- *If there is a malfunction with the push button start function, the push button start indicator light (amber) flashes. In this case, the engine may start, however, have the vehicle checked at an Authorized Mazda Dealer as soon as possible.*
- *If the push button start indicator light (green) does not illuminate, perform the operation from the beginning again. If it does not illuminate, have the vehicle checked at an Authorized Mazda Dealer.*
- *To switch the ignition position without starting the engine, perform the following operations after the push button start indicator light (green) turns on.*
 1. *Release the clutch pedal (manual transmission) or brake pedal (automatic transmission).*
 2. *Press the push button start to switch the ignition position. The ignition switches in the order of ACC, ON, and off each time the push button start is pressed. To switch the ignition position again, perform the operation from the beginning.*

▼ Emergency Operation for Starting the Engine

If the KEY warning light (red) illuminates, or the push button start indicator light (amber) flashes, this could indicate that the engine may not start using the usual starting method. Have your vehicle inspected at an Authorized Mazda Dealer as soon as possible. If this occurs, the engine can be force-started. Press and hold the push button start until the engine starts. Other procedures necessary for starting the engine such as having the key in the cabin, and depressing the clutch pedal (manual transmission) or the brake pedal (automatic transmission) are required.

Start/Stop Engine

Turning the Engine Off

WARNING

Do not stop the engine while the vehicle is moving:

Stopping the engine while the vehicle is moving for any reason other than in an emergency is dangerous. Stopping the engine while the vehicle is moving will result in reduced braking ability due to the loss of power braking, which could cause an accident and serious injury.

1. Stop the vehicle completely.
2. **(Manual transmission)**
Shift into neutral and set the parking brake.
(Automatic transmission)
Shift the selector lever to the P position and set the parking brake.
3. Press the push button start to turn off the engine. The ignition position is off.

CAUTION

When leaving the vehicle, make sure the push button start is off.

NOTE

- *The cooling fan in the engine compartment could turn on for a few minutes after the ignition is switched from ON to OFF, whether or not the A/C is on or off, to cool the engine compartment quickly.*
- *When the push button start is pressed from ON to ACC or OFF, the KEY indicator light (green) may flash for approximately 30 seconds indicating that the remaining battery power of the key is low.
Replace with a new battery before the key becomes unusable.
Refer to Key Battery Replacement on page 6-38.*
- **(Automatic transmission)**
If the engine is turned off while the selector lever is in a position other than P, the ignition switches to ACC.

▼ Emergency Engine Stop

Continuously pressing the push button start or quickly pressing it any number of times while the engine is running or the vehicle is being driven will turn the engine off immediately. The ignition switches to ACC.

Meters and Gauges

Instrument Cluster

Type A

(With Multi-information Display)

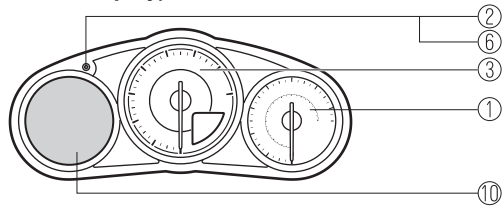

Type B

(Without Multi-information Display)

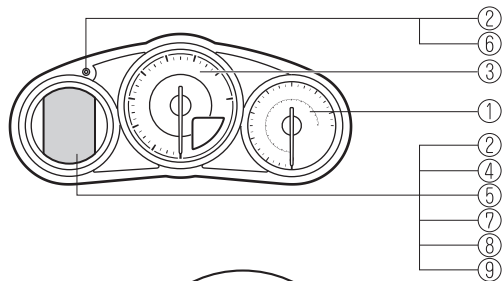

Steering Switch

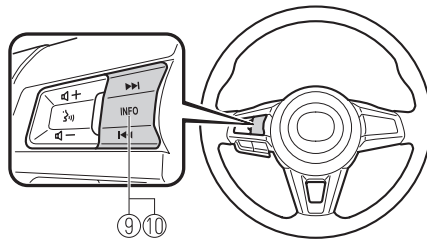

① Speedometer.....	page 4-12
② Odometer, Trip Meter and Trip Meter Selector	page 4-12
③ Tachometer.....	page 4-13
④ Engine Coolant Temperature Gauge	page 4-13
⑤ Fuel Gauge.....	page 4-14
⑥ Dashboard Illumination.....	page 4-15
⑦ Outside Temperature Display.....	page 4-15
⑧ Cruise Control Set Vehicle Speed Display.....	page 4-16
⑨ Trip Computer and INFO Switch.....	page 4-16
⑩ Multi-information Display and INFO Switch.....	page 4-18

Instrument Cluster and Display

▼ Speedometer

The speedometer indicates the speed of the vehicle.

▼ Odometer, Trip Meter and Trip Meter Selector (Without Multi-information Display)

The display mode can be changed from odometer to trip meter A to trip meter B and then back to odometer by pressing the selector while one of them is displayed. The selected mode will be displayed.

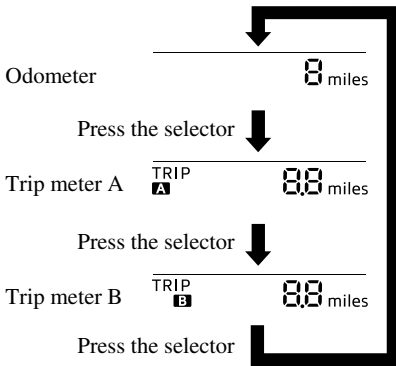
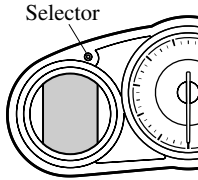

NOTE

When the ignition is switched to ACC or off, the odometer or trip meters cannot be displayed, however, pressing the selector can inadvertently switch the trip meters or reset them during an approximate ten-minute period in the following cases:

- After the ignition is switched to off from ON.
- After the driver's door is opened.

Odometer

The odometer records the total distance the vehicle has been driven.

Trip meter

The trip meter can record the total distance of two trips. One is recorded in trip meter A, and the other is recorded in trip meter B.

For instance, trip meter A can record the distance from the point of origin, and trip meter B can record the distance from where the fuel tank is filled.

When trip meter A is selected, pressing the selector again within one second will change to trip meter B mode.

When trip meter A is selected, TRIP A will be displayed. When trip meter B is selected, TRIP B will be displayed.

The trip meter records the total distance the vehicle is driven until the meter is again reset. Return it to "0.0" by depressing and holding the selector for one second or more. Use this meter to measure trip distances and to compute fuel consumption.

Instrument Cluster and Display

NOTE

• (Vehicles with type B audio)

If the fuel economy data is reset using the fuel economy monitor, or trip A is reset using the trip meter when the function which synchronizes the fuel economy monitor and the trip meter is on, the fuel economy data and trip A are reset simultaneously.

Refer to Fuel Economy Monitor on page 4-69.

- Only the trip meters record tenths of kilometers (miles).
- The trip record will be erased when:
 - The power supply is interrupted (blown fuse or the battery is disconnected).
 - The vehicle is driven over 9999.9 km (mile).

▼ Tachometer

The tachometer shows engine speed in thousands of revolutions per minute (rpm).



Do not run the engine with the tachometer needle in the RED ZONE. This may cause severe engine damage.

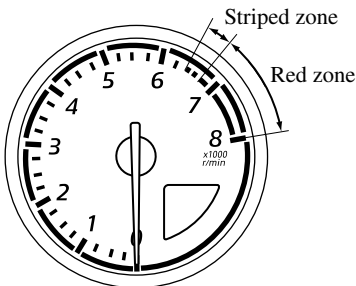

NOTE

When the tachometer needle enters the STRIPED ZONE, this indicates to the driver that the gears should be shifted before entering the RED ZONE.

▼ Engine Coolant Temperature Gauge (Without Multi-information Display)

Indicates engine coolant temperature.

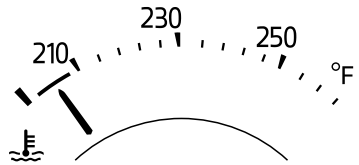

If the high engine coolant temperature warning light (red) turns on, there is a possibility of overheating. Park the vehicle in a safe place immediately and take appropriate measures. If the vehicle continues to be driven, it could cause damage to the engine. Refer to Overheating on page 7-27.

Instrument Cluster and Display

NOTE

- The temperature unit (Centigrade/ Fahrenheit) of the engine coolant gauge display changes in conjunction with the temperature unit of the outside temperature display.
Refer to Personalization Features on page 9-9.
- During normal driving, the engine coolant temperature stabilizes at 100 °C (210 °F) or less, and the gauge indicates a range lower than 100 °C (210 °F).
- If the engine load increases and the engine coolant temperature exceeds 100 °C (210 °F), the gauge indicates the engine coolant temperature.

▼ Fuel Gauge (Without Multi-information Display)

The fuel gauge shows approximately how much fuel is remaining in the tank when the ignition is switched ON. We recommend keeping the tank over 1/4 full.

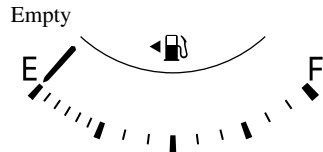
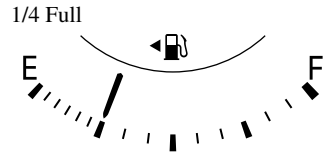
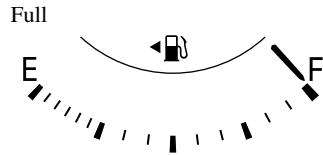

If the low fuel warning light illuminates or the fuel level is very low, refuel as soon as possible.

Refer to Warning Lights on page 4-26.

NOTE

- After refueling, it may require some time for the indicator to stabilize. In addition, the indicator may deviate while driving on a slope or curve since the fuel moves in the tank.
- The display indicating a quarter or less remaining fuel has more segments to show the remaining fuel level in greater detail.
- The direction of the arrow (◀) indicates that the fuel-filler lid is on the left side of the vehicle.

Instrument Cluster and Display

▼ Dashboard Illumination

When the position lights are turned on with the ignition switched ON, the brightness of the instrument panel illumination is dimmed.

NOTE

When the position lights are turned on, the position lights indicator light in the instrument cluster turns on.

Refer to Headlights on page 4-45.

The brightness of the instrument cluster and dashboard illuminations can be adjusted by rotating the knob.

- The brightness decreases by rotating the knob to the left. A beep sound will be heard when the knob has been rotated to the maximum dim position.
- The brightness increases by rotating the knob to the right.

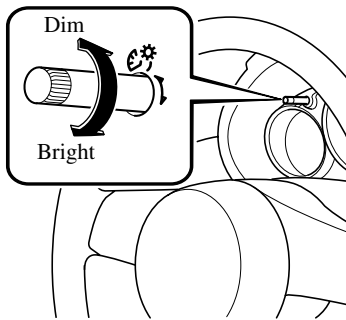

Function for cancelling illumination dimmer

The illumination dimmer can be canceled by rotating the dashboard illumination knob to the right until a beep sound is heard while the instrument cluster is dimmed with the ignition switched ON. If the instrument cluster's visibility is reduced due to glare from surrounding brightness, cancel the illumination dimmer.

NOTE

- *When the illumination dimmer is canceled, the instrument cluster cannot be dimmed even if the position lights are turned on.*
- *When the illumination dimmer is canceled, the screen in the center display switches to constant display of the daytime screen.*

▼ Outside Temperature Display (Without Multi-information Display)

When the ignition is switched ON, the outside temperature is displayed.

78°F

NOTE

Under the following conditions, the outside temperature display may differ from the actual outside temperature depending on the surroundings and vehicle conditions:

- *Significantly cold or hot temperatures.*
- *Sudden changes in outside temperature.*
- *The vehicle is parked.*
- *The vehicle is driven at low speeds.*

Instrument Cluster and Display

Changing the Temperature Unit of the Outside Temperature Display

The outside temperature unit can be switched between Celsius and Fahrenheit using the following procedure.

(Vehicles with Type B)

Settings can be changed by operating the center display screen.

Refer to Personalization Features on page 9-9.

(Vehicles without Type B)

1. Press the INFO switch with the ignition switched off and continue pressing the INFO switch for 5 seconds or longer while switching the ignition ON. The outside temperature display flashes.
2. Press the INFO switch to change the outside temperature unit.
3. Press and hold the INFO switch for 3 seconds or longer while the outside temperature display is flashing. The outside temperature display illuminates.

NOTE

When the temperature unit indicated in the outside temperature display is changed, the temperature unit indicated in the engine coolant gauge display changes in conjunction with it.

▼ Cruise Control Set Vehicle Speed Display (Without Multi-information Display)*

The vehicle speed preset using the cruise control is displayed.



▼ Trip Computer and INFO Switch (Without Multi-information Display)

The following information can be selected by pressing the INFO switch with the ignition switched ON.

- Approximate distance you can travel on the available fuel
- Average fuel economy
- Current fuel economy
- Average vehicle speed

If you have any problems with your trip computer, consult an Authorized Mazda Dealer.

Distance-to-empty mode

This mode displays the approximate distance you can travel on the remaining fuel based on the fuel economy.

The distance-to-empty will be calculated and displayed every second.



Instrument Cluster and Display

NOTE

- Even though the distance-to-empty display may indicate a sufficient amount of remaining driving distance before refueling is required, refuel as soon as possible if the fuel level is very low or the low fuel warning light illuminates.
- The display may not change unless you add more than approximately 9 L (2.3 US gal, 1.9 Imp gal) of fuel.
- The distance-to-empty is the approximate remaining distance the vehicle can be driven until all the graduation marks in the fuel gauge (indicating the remaining fuel supply) disappear.
- If there is no past fuel economy information such as after first purchasing your vehicle or the information is deleted when the battery cables are disconnected, the actual distance-to empty/range may differ from the amount indicated.

Average fuel economy mode

This mode displays the average fuel economy by calculating the total fuel consumption and the total traveled distance since purchasing the vehicle, re-connecting the battery after disconnection, or resetting the data. The average fuel economy is calculated and displayed every minute.

AVG

22.4 mpg

To clear the data being displayed, press the INFO switch for more than 1.5 seconds. After pressing the INFO switch, - - - L/100 km (- - - mpg) will be displayed for about 1 minute before the fuel economy is recalculated and displayed.

Current fuel economy mode

This mode displays the current fuel economy by calculating the amount of fuel consumption and the distance traveled.

Current fuel economy will be calculated and displayed every 2 seconds.

CURRENT
19.7 mpg

When you've slowed to about 5 km/h (3 mph), - - - L/100 km (- - - mpg) will be displayed.

Average vehicle speed mode

This mode displays the average vehicle speed by calculating the distance and the time traveled since connecting the battery or resetting the data.

Average vehicle speed will be calculated and displayed every 10 seconds.

AVG

25

mph

To clear the data being displayed, press the INFO switch for more than 1.5 seconds.

After pressing the INFO switch, - - - km/h (- - - mph) will be displayed for about 1 minute before the vehicle speed is recalculated and displayed.

Instrument Cluster and Display

Multi-information Display and INFO Switch *

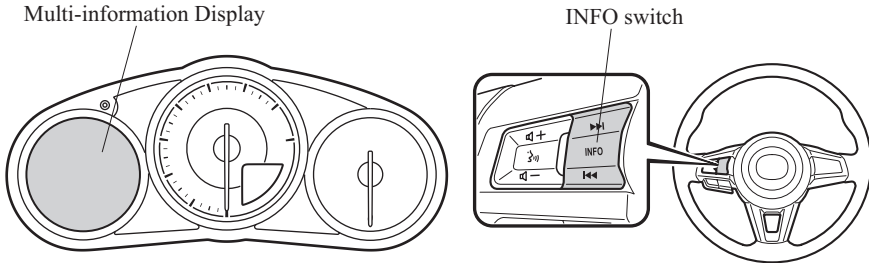

The multi-information display indicates the following information.

- Odometer
- Trip meter
- Engine coolant temperature gauge
- Fuel gauge
- Outside temperature
- Distance-to-empty
- Average fuel economy
- Current fuel economy
- Maintenance Monitor
- Lane Departure Warning System (LDWS) Display
- Cruise Control Display
- Compass Display
- Roof Operation Display
- Warning message

Instrument Cluster and Display

The screen content changes each time the INFO switch is pressed.

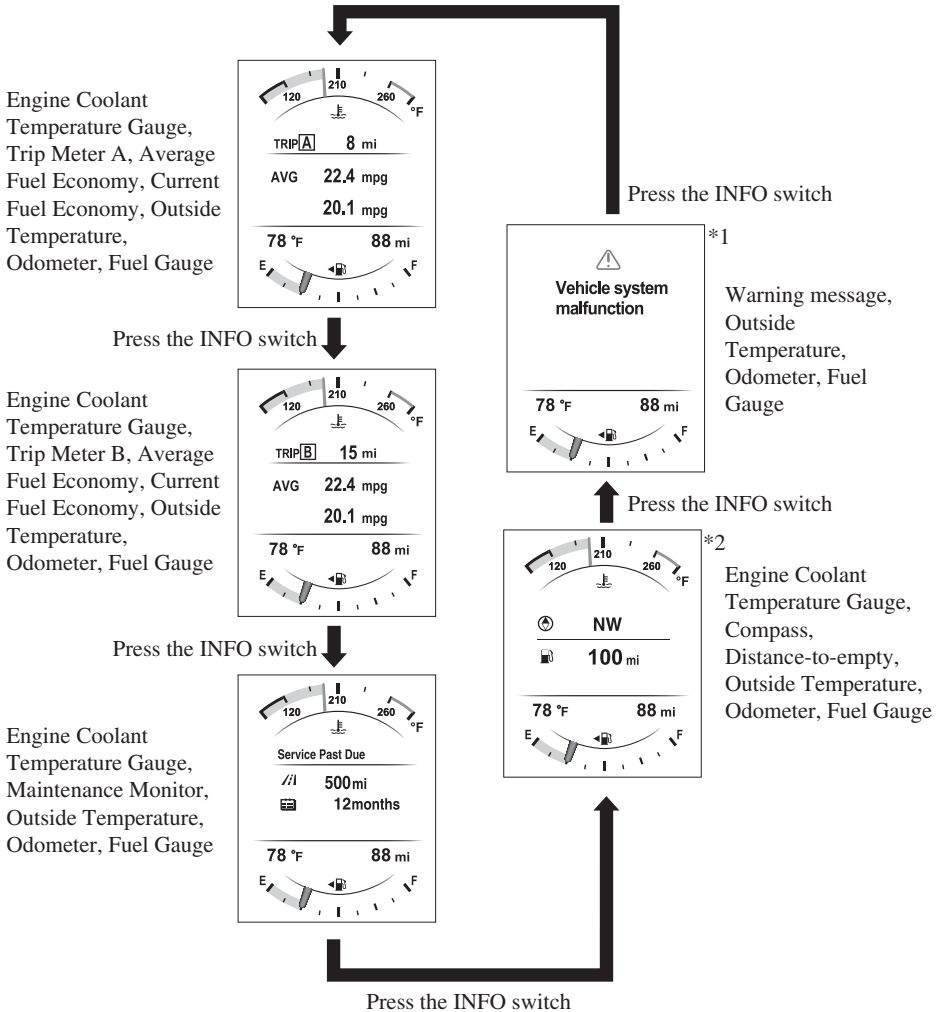

*1: Displayed only when a warning occurs.
 *2: Displayed only while vehicle is being driven.

Instrument Cluster and Display

▼ Odometer, Trip Meter and Trip Meter Selector

The odometer is constantly displayed on the screen when the ignition is switched ON, and the TRIP A or TRIP B screen can be displayed by operating the INFO switch.

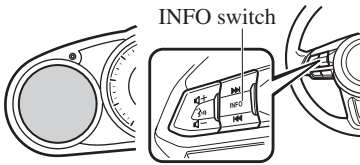

TRIP A	8 mi
AVG	22.4 mpg
Odometer	20.1 mpg
78 °F	88 mi

Press the INFO switch ↓

TRIP B	15 mi
AVG	22.4 mpg
Odometer	20.1 mpg
78 °F	88 mi

Odometer

The odometer records the total distance the vehicle has been driven.

Trip meter

The driving distance for a specified interval is indicated. Two types (TRIP A, TRIP B) of interval distance and the average fuel economy for each can be measured.

For instance, trip meter A can record the distance from the point of origin, and trip meter B can record the distance from where the fuel tank is filled.

When trip meter A is selected, TRIP A will be displayed. When trip meter B is selected, TRIP B will be displayed.

The trip meter and average fuel economy can be reset by pressing the INFO switch for 1.5 second or more while in each mode.

NOTE

- Only the trip meters record tenths of kilometers (miles).
- The trip record will be erased when:
 - The power supply is interrupted (blown fuse or the battery is disconnected).
 - The vehicle is driven over 1999 km (mile).

Instrument Cluster and Display

▼ Engine Coolant Temperature Gauge

Displays the engine coolant temperature. The blue gauge indicates that the engine coolant temperature is low, and the red gauge indicates that the engine coolant temperature is high and overheating.

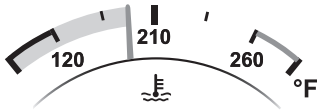

⚠ CAUTION

If the high engine coolant temperature warning light (red) turns on, there is a possibility of overheating. Park the vehicle in a safe place immediately and take appropriate measures. If the vehicle continues to be driven, it could cause damage to the engine. Refer to Overheating on page 7-27.

NOTE

- The temperature unit (Centigrade/ Fahrenheit) of the engine coolant gauge display changes in conjunction with the temperature unit of the outside temperature display. Refer to Personalization Features on page 9-9.
- During normal driving, the engine coolant temperature stabilizes at 100 °C (210 °F) or less, and the gauge indicates a range lower than 100 °C (210 °F).
- If the engine load increases and the engine coolant temperature exceeds 100 °C (210 °F), the gauge indicates the engine coolant temperature.

▼ Fuel Gauge

The fuel gauge shows approximately how much fuel is remaining in the tank when the ignition is switched ON. We recommend keeping the tank over 1/4 full.



If the fuel level is low, (◀) and (E) turn an amber color. Refuel as soon as possible. Refer to Taking Action on page 7-41 .

NOTE

- After refueling, it may require some time for the indicator to stabilize. In addition, the indicator may deviate while driving on a slope or curve since the fuel moves in the tank.
- The display indicating a quarter or less remaining fuel has more segments to show the remaining fuel level in greater detail.
- The direction of the arrow (◀) indicates that the fuel-filler lid is on the left side of the vehicle.

Instrument Cluster and Display

▼ Outside Temperature Display

When the ignition is switched ON, the outside temperature is displayed.

78 °F

NOTE

Under the following conditions, the outside temperature display may differ from the actual outside temperature depending on the surroundings and vehicle conditions:

- Significantly cold or hot temperatures.
- Sudden changes in outside temperature.
- The vehicle is parked.
- The vehicle is driven at low speeds.

Changing the Temperature Unit of the Outside Temperature Display

The outside temperature unit can be switched between Celsius and Fahrenheit using the following procedure.

(Vehicles with Type B)

Settings can be changed by operating the center display screen.

Refer to Personalization Features on page 9-9.

(Vehicles without Type B)

1. Press the INFO switch with the ignition switched off and continue pressing the INFO switch for 5 seconds or longer while switching the ignition ON. The outside temperature display flashes.
2. Press the INFO switch to change the outside temperature unit.
3. Press and hold the INFO switch for 3 seconds or longer while the outside temperature display is flashing. The outside temperature display illuminates.

NOTE

When the temperature unit indicated in the outside temperature display is changed, the temperature unit indicated in the engine coolant gauge display changes in conjunction with it.

▼ Distance-to-empty

This displays the approximate distance you can travel on the remaining fuel based on the fuel economy.

The distance-to-empty will be calculated and displayed every second.

 100 mi

NOTE

- Even though the distance-to-empty display may indicate a sufficient amount of remaining driving distance before refueling is required, refuel as soon as possible if the fuel level is very low or the low fuel warning light illuminates.
- The display will not change unless you add more than approximately 9 L (2.3 US gal, 1.9 Imp gal) of fuel.
- The distance-to-empty is the approximate remaining distance the vehicle can be driven until all the graduation marks in the fuel gauge indicating the remaining fuel supply disappear.
- If there is no past fuel economy information such as after first purchasing your vehicle or the information is deleted when the battery cables are disconnected, the actual distance-to empty/range may differ from the amount indicated.

Instrument Cluster and Display

▼ Average Fuel Economy

This mode displays the average fuel economy by calculating the total fuel consumption and the total traveled distance since purchasing the vehicle, re-connecting the battery after disconnection, or resetting the data.

The average fuel economy is calculated and displayed every minute.

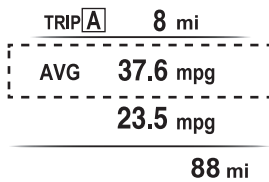

To clear the data being displayed, press the INFO switch for more than 1.5 seconds. After pressing the INFO switch, - - - L/100 km (- - - mpg) will be displayed for about 1 minute before the fuel economy is recalculated and displayed.

▼ Current Fuel Economy

This displays the current fuel economy by calculating the amount of fuel consumption and the distance traveled. Current fuel economy will be calculated and displayed every two seconds.

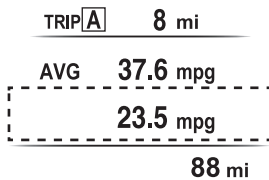

When you've slowed to about 5 km/h (3 mph), - - - L/100 km (- - - mpg) will be displayed.

▼ Maintenance Monitor

The following maintenance period notifications can be displayed by turning the Maintenance Monitor on.

- Scheduled Maintenance
- Tire Rotation
- Oil Change

For the setting method and indications for the maintenance monitor, refer to the Maintenance Monitor.

Refer to Maintenance Monitor on page 6-20.

The maintenance monitor displays the information when the ignition is switched ON.

NOTE

This function is inoperable while the vehicle is being driven.

Message display

When the remaining time or the distance approaches 0, a message is displayed each time the ignition is switched ON.

Service Past Due	
/!	500mi
	12months

Instrument Cluster and Display

NOTE

- If any of the INFO switch is pressed while a message is displayed, it will no longer be displayed the next time the ignition is switched ON.
- After the vehicle is serviced and the remaining time/distance is reset, the message for the next maintenance period will be displayed when the remaining distance or time to the next maintenance period approaches 0 (displays when engine is started).
- If there are multiple messages, they are displayed according to their order.
- If OFF is set for Messages, messages are not displayed.

▼ Lane Departure Warning System (LDWS) Display*

Displays the system status.

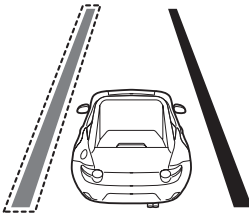

Refer to Lane Departure Warning on page 4-83.

▼ Cruise Control Set Vehicle Speed Display

The vehicle speed preset using the cruise control is displayed.



▼ Compass Display

The direction the vehicle is moving is displayed in one of the eight cardinal directions while the vehicle is being driven.



NW

Display	Direction
N	North
S	South
E	East
W	West
NE	Northeast
NW	Northwest
SE	Southeast
SW	Southwest

▼ Roof Operation Display

Displays the roof operation status.

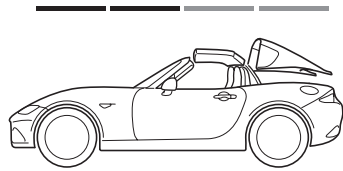

Refer to Operation Indication on page 3-42.

▼ Warning (Display Indication)

A message is displayed to notify the user of the system operation status and malfunctions or abnormalities.

If the warning light turns on/flashes simultaneously or a symbol is indicated in the display, check the information regarding the warning light or symbol. (page 4-26)

When only a message is displayed, refer to Message Indicated in Multi-information Display. (page 7-45)

Instrument Cluster and Display

Warning/Indicator Lights

Instrument Cluster varies depending on model and specifications.

Instrument Cluster

Type A
(With Multi-information Display)

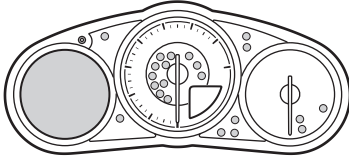

Type B
(Without Multi-information Display)

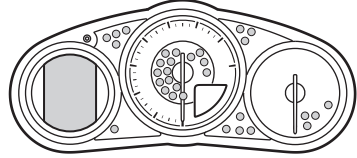



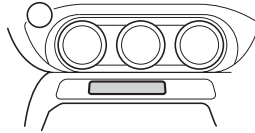



Center of Dashboard















Warning/Indicator lights will appear in any of the highlighted areas

▼ Warning Indication/Warning Lights







These lights turn on or flash to notify the user of the system operation status or a system malfunction.

Signal	Warning Lights	Page
 BRAKE	Brake System Warning Light* ^{1,2}	7-33
	Charging System Warning Indication/Warning Light* ¹	7-33
	Engine Oil Warning Light* ¹	7-33
 (Red)	High Engine Coolant Temperature Warning Indication/Warning Light* ¹	7-33
	Power Steering Malfunction Indicator Light* ¹	7-33
	*Master Warning Indication/Warning Light* ¹	7-36

Instrument Cluster and Display

Signal	Warning Lights	Page
	Electric Vacuum Pump Warning Light* ¹	7-36
	ABS Warning Light* ¹	Electronic Brake Force Distribution System Warning 7-33
		ABS warning 7-36
	Check Engine Light* ¹	7-36
AT	*Automatic Transmission Warning Indication/Warning Light* ¹	7-36
	Air Bag/Seat Belt Pretensioner System Warning Light* ¹	7-36
	*Tire Pressure Monitoring System Warning Light* ¹	Flashing 7-36
		Illuminate 7-41
 (Red)	*KEY Warning Indication/Warning Light* ¹	Malfunction 7-36
		Except malfunction 7-41
 (Amber)	*KEY Warning Indication	7-36
	*Lane Departure Warning System (LDWS) Warning Indication/Warning Light* ¹	Illuminated 7-36
		Flashing 4-83
 (Amber)	*High Beam Control System (HBC) Warning Indication/Warning Light* ¹	7-36
	*Blind Spot Monitoring (BSM) Warning Indication	7-36
	*Retractable Fastback Warning Indication	7-36
	LED Headlight Warning Light* ¹	7-36

Instrument Cluster and Display



Signal	Warning Lights	Page
	Seat Belt Warning Light	7-41
	*Door-Ajar Warning Light	7-41
	*Door-Ajar Warning Indication	7-41
	*Trunk lid-Ajar Warning Indication	7-41
	*Low Fuel Warning Indication/Warning Light	7-41
	Check Fuel Cap Warning Light* ¹	7-41
	*Low Washer Fluid Level Warning Indication/Warning Light	7-41

*1 The light turns on when the ignition is switched on for an operation check, and turns off a few seconds later or when the engine is started. If the light does not turn on or remains turned on, have the vehicle inspected at an Authorized Mazda Dealer.











*2 The light turns on continuously when the parking brake is applied.

▼ Indication/Indicator Lights





These lights turn on or flash to notify the user of the system operation status or a system malfunction.

Signal	Indicator Lights	Page
	*Passenger Air Bag Deactivation Indicator Light* ¹	2-37
 (White/Green)	*KEY Indicator/Indicator Light	3-8

Instrument Cluster and Display

Signal	Indicator Lights	Page
	Security Indicator Light* ¹	3-48
	*Retractable Fastback Operation Indicator Light	3-42
	*Wrench Indication/Indicator Light* ¹	4-30
 (Blue)	Low Engine Coolant Temperature Indicator Light	4-30
	*Shift Position Indication	4-35
	Lights-On Indicator Light	4-45
	Headlight High-Beam Indicator Light	Headlight High-Low Beam 4-48
		Flashing the Headlights 4-48
	Turn Signal/Hazard Warning Indicator Lights	Turn and Lane-Change Signals 4-50
		Hazard Warning Flasher 4-57
	TCS/DSC Indicator Light* ¹	Traction Control System (TCS) 4-66
		Dynamic Stability Control (DSC) 4-67
		(Turns on) 7-36
	DSC OFF Indicator Light* ¹	4-68
SPORT	*Select Mode Indication	4-72
 (White)	*Tire Pressure Monitoring System Indication	4-108

Instrument Cluster and Display

Signal	Indicator Lights	Page
 (Green)	*High Beam Control System (HBC) Indicator Light	4-78
	*Blind Spot Monitoring (BSM) OFF Indicator Light* ¹	4-90
	*Lane Departure Warning System (LDWS) OFF Indicator Light* ¹	4-82
 (White/Amber)	Cruise Main Indication/Indicator Light	4-101
 (Green)	Cruise Set Indication/Indicator Light	4-101

*1 The light turns on when the ignition is switched on for an operation check, and turns off a few seconds later or when the engine is started. If the light does not turn on or remains turned on, have the vehicle inspected at an Authorized Mazda Dealer.

▼ Wrench Indication/Indicator Light*



Type A instrument cluster

Perform maintenance in accordance with the message.

Type B instrument cluster

When the ignition is switched ON, the wrench indicator light is illuminated and then turns off after a few seconds.

The wrench indicator light is illuminated when the preset maintenance period arrives. Verify the content and perform maintenance.

Refer to Maintenance Monitor on page 6-20.

▼ Low Engine Coolant Temperature Indicator Light (Blue)



The light illuminates continuously when the engine coolant temperature is low and turns off after the engine is warm.

If the low engine coolant temperature indicator light remains illuminated after the engine has been sufficiently warmed up, the temperature sensor could have a malfunction. Consult an Authorized Mazda Dealer.

Manual Transmission Operation

▼ Manual Transmission Shift Pattern

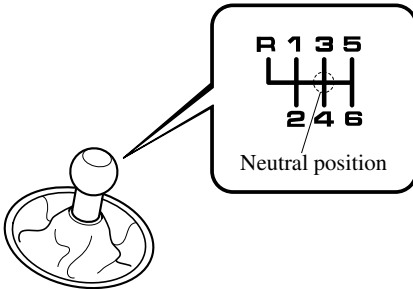

The shift pattern of the transmission is conventional, as shown.

Depress the clutch pedal all the way down while shifting; then release it slowly.

Your vehicle is equipped with a device to prevent shifting to R (reverse) by mistake. Push the shift lever downward and shift to R.

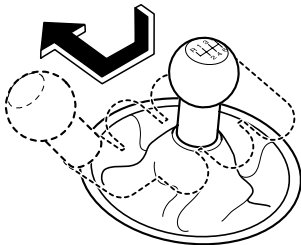

⚠ WARNING

Do not use sudden engine braking on slippery road surfaces or at high speeds:

Shifting down while driving on wet, snowy, or frozen roads, or while driving at high speeds causes sudden engine braking, which is dangerous. The sudden change in tire speed could cause the tires to skid. This could lead to loss of vehicle control and an accident.

Always leave the shift lever in 1 or R position and set the parking brake when leaving the vehicle unattended:

Otherwise the vehicle could move and cause an accident.

⚠ CAUTION

- *Keep your foot off the clutch pedal except when shifting gears. Also, do not use the clutch to hold the vehicle on an upgrade. Riding the clutch will cause needless clutch wear and damage.*
- *Do not apply any excessive lateral force to the shift lever when changing from 5th to 4th gear. This could lead to the accidental selection of 2nd gear, which could result in damage to the transmission.*
- *Make sure the vehicle comes to a complete stop before shifting to R. Shifting to R while the vehicle is still moving may damage the transmission.*

Transmission

NOTE

- *A natural driving posture can be realized by lightly gripping the shift lever from the side without having to rest your elbow on the center console box.*

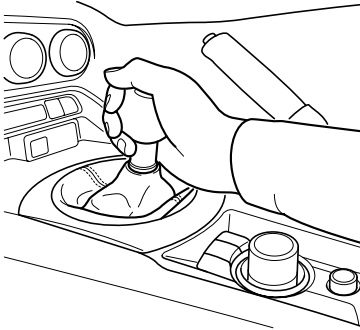

- *If shifting to R is difficult, shift back into neutral, release the clutch pedal, and try again.*

▼ Gear Shift Indicator

The gear shift indicator supports you to obtain optimum fuel economy and smooth driving. It displays the selected gear position in the instrument cluster as well as notifies the driver to change to the most suitable gear position corresponding to the actual driving condition.

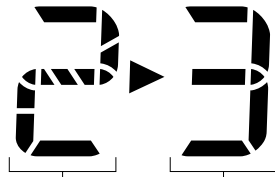

Selected gear position

Suitable gear position

Indication	Condition
Numeral	The selected gear position is displayed.
▶ and numeral	Shift up or down to the indicated gear position is recommended.

⚠ CAUTION

Do not rely solely on the shift-up/ shift-down recommendations by indications. The actual driving situation might require shift operations different from indication. To avoid the risk of accidents, the road and traffic conditions have to be judged correctly by the driver before shifting.

NOTE

The gear shift indicator turns off when the following operations are performed.

- The vehicle is stopped.
- The vehicle is put in neutral.
- The vehicle is driven in reverse.
- The clutch is not fully engaged when accelerating from a stop.
- The clutch pedal remains depressed for 2 seconds or longer while driving.

▼ Recommendations for Shifting**Upshifting**

For normal acceleration, Mazda recommends these shift points:

Gear	Vehicle speed
1 to 2	23 km/h (14 mph)
2 to 3	39 km/h (24 mph)
3 to 4	53 km/h (33 mph)
4 to 5	61 km/h (38 mph)
5 to 6	77 km/h (48 mph)

For cruising, Mazda recommends these shift points:

Gear	Vehicle speed
1 to 2	11 km/h (7 mph)
2 to 3	31 km/h (19 mph)
3 to 4	42 km/h (26 mph)
4 to 5	55 km/h (34 mph)
5 to 6	66 km/h (41 mph)

Downshifting



When you must slow down in heavy traffic or on a steep **upgrade**, downshift before the engine starts to overwork. This reduces the chance of stalling and gives better acceleration when you need more speed.

On a steep **downgrade**, downshifting helps maintain safe speed and prolongs brake life.

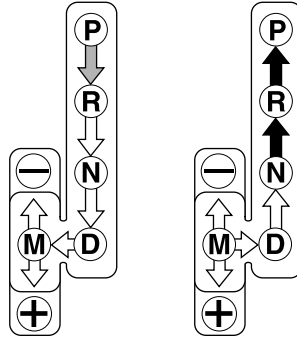
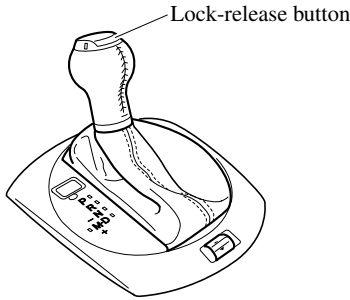
Automatic Transmission Controls



Various Lockouts:

-  Indicates that you must depress the brake pedal and hold in the lock-release button to shift (The ignition must be switched ON).
-  Indicates the selector lever can be shifted freely into any position.
-  Indicates that you must hold in the lock-release button to shift.

NOTE

The Sport AT has an option that is not included in the traditional automatic transmission that gives the driver the option of selecting each gear instead of leaving it to the transmission to shift gears. Even if you intend to use the automatic transmission functions as a traditional automatic, you should also be aware that you can inadvertently shift into manual shift mode and an inappropriate gear may be retained as the vehicle speed increases. If you notice the engine speed going higher or hear the engine racing, confirm you have not accidentally slipped into manual shift mode (page 4-37).

▼ Shift Position Indication

The selector position is indicated when the ignition is switched ON.

Gear position indication

In manual shift mode, the “M” of the shift position indication illuminates and the numeral for the selected gear is displayed.

▼ Warning Light

The warning light turns on when the system has a malfunction. Refer to Warning Indication/Warning Lights on page 4-26.

▼ Transmission Ranges

- The shift position indicator light in the instrument cluster illuminates. Refer to Warning/Indicator Lights on page 4-26.
- The selector lever must be in P or N to operate the starter.

P (Park)

P locks the transmission and prevents the rear wheels from rotating.

**WARNING**

Always set the selector lever to P and set the parking brake:

Only setting the selector lever to the P position without using the parking brake to hold the vehicle is dangerous. If P fails to hold, the vehicle could move and cause an accident.

**CAUTION**

- > *Shifting into P, N or R while the vehicle is moving can damage your transmission.*
- > *Shifting into a driving gear or reverse when the engine is running faster than idle can damage the transmission.*

R (Reverse)

In position R, the vehicle moves only backward. You must be at a complete stop before shifting to or from R, except under rare circumstances as explained in Rocking the Vehicle (page 3-53).

N (Neutral)

In N, the wheels and transmission are not locked. The vehicle will roll freely even on the slightest incline unless the parking brake or brakes are on.

**WARNING**

If the engine is running faster than idle, do not shift from N or P into a driving gear:

It's dangerous to shift from N or P into a driving gear when the engine is running faster than idle. If this is done, the vehicle could move suddenly, causing an accident or serious injury.

Do not shift into N when driving the vehicle:

Shifting into N while driving is dangerous. Engine braking cannot be applied when decelerating which could lead to an accident or serious injury.

Transmission

⚠ CAUTION

Do not shift into N when driving the vehicle. Doing so can cause transmission damage.

NOTE

Apply the parking brake or depress the brake pedal before moving the selector lever from N to prevent the vehicle from moving unexpectedly.

D (Drive)

D is the normal driving position. From a stop, the transmission will automatically shift through a 6-gear sequence.

M (Manual)

M is the manual shift mode position. Gears can be shifted up or down by operating the selector lever. Refer to Manual Shift Mode on page 4-37.

▼ Active Adaptive Shift (AAS)

Active Adaptive Shift (AAS) automatically controls the transmission shift points to best suit the road conditions and driver input. This improves driving feel. The transmission may switch to AAS mode when driving up and down slopes, cornering, driving at high elevations, or depressing the accelerator pedal quickly while the selector lever is in the D position. Depending on the road and driving conditions/vehicle operations, gear shifting could be delayed or not occur, however, this does not indicate a problem because the AAS mode will maintain the optimum gear position.

▼ Shift-Lock System

The shift-lock system prevents shifting out of P unless the brake pedal is depressed.

To shift from P:

1. Depress and hold the brake pedal.
2. Start the engine.
3. Press and hold the lock-release button.
4. Move the selector lever.

NOTE

- When the ignition is switched to ACC or the ignition is switched off, the selector lever cannot be shifted from P.
- The ignition cannot be switched to OFF if the selector lever is not in P.

▼ Shift-Lock Override

If the selector lever will not move from P using the proper shift procedure, continue to hold down the brake pedal.

1. Remove the shift-lock override cover using a cloth-wrapped flat head screwdriver.
2. Insert a screwdriver and push it down.

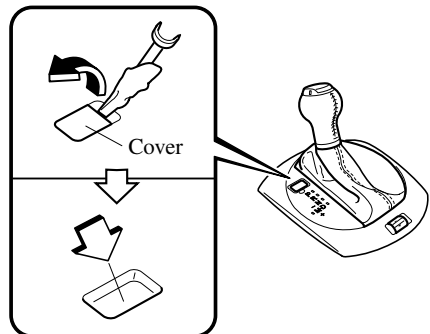

3. Press and hold the lock-release button.
4. Move the selector lever.

Take the vehicle to an Authorized Mazda Dealer to have the system checked.

▼ Manual Shift Mode

The manual shift mode gives you the feel of driving a manual transmission vehicle by allowing you to operate the selector lever manually. This allows you to control engine rpm and torque to the drive wheels much like a manual transmission when more control is desired.

To change to manual shift mode, shift the lever from D to M.

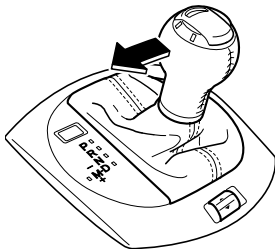

NOTE

Changing to manual shift mode while driving will not damage the transmission.

To return to automatic shift mode, shift the lever from M to D.

NOTE

- *If you change to manual shift mode when the vehicle is stopped, the gear will shift to M1.*
- *If you change to manual shift mode without depressing the accelerator pedal when driving in D range, 5th gear/6th gear, the gear will shift to M4/M5.*

Indicators

Manual shift mode indication

In manual shift mode, the “M” of the shift position indication in the instrument panel illuminates.

Gear position indication

The numeral for the selected gear illuminates.

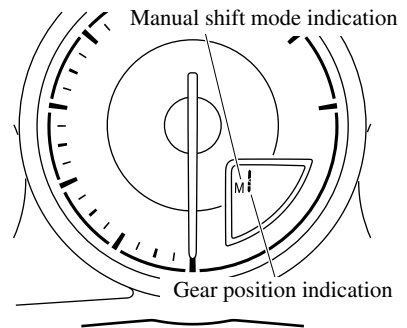

NOTE

If the gears cannot be shifted down when driving at higher speeds, the gear position indication will flash twice to signal that the gears cannot be shifted down (to protect the transmission).

Transmission

Manually shifting up

You can shift gears up by operating the selector lever or the steering shift switches*.

M1 → M2 → M3 → M4 → M5 → M6

Using selector lever

To shift up to a higher gear, tap the selector lever back + once.

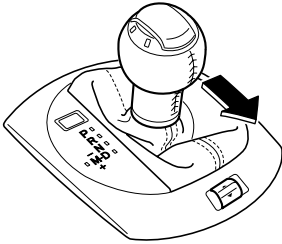

Using steering shift switch*

To shift up to a higher gear with the steering shift switches, pull the UP switch (+/OFF) toward you once with your fingers.

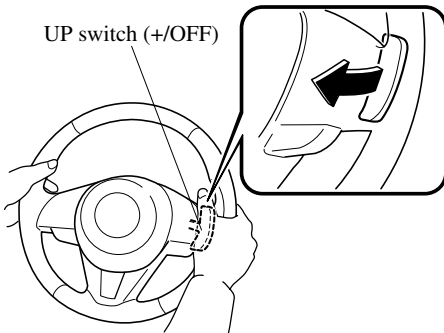

! WARNING

Keep your hands on the steering wheel rim when using fingers on the steering shift switches:

Putting your hands inside the rim of the steering wheel when using the steering shift switches is dangerous. If the driver's air bag were to deploy in a collision, your hands could be impacted causing injury.

NOTE

- When driving slowly, the gears may not shift up.
- Do not drive the vehicle with the tachometer needle in the RED ZONE while in manual shift mode. In addition, manual shift mode switches to automatic shift mode while the accelerator pedal is completely depressed.

This function is canceled while the DSC is turned off. However, if the vehicle is continuously driven at a high rpm, the gears may automatically shift up to protect the engine.

- The steering shift switch can be used temporarily even if the selector lever is in the D position while driving. In addition, it returns to automatic shift mode when the UP switch (+/OFF) is pulled rearward for a sufficient amount of time.

Manually shifting down

You can shift gears down by operating the selector lever or the steering shift switches*.

M6 → M5 → M4 → M3 → M2 → M1

Using selector lever

To shift down to a lower gear, tap the selector lever forward — once.

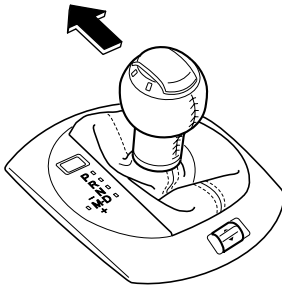

Using steering shift switch*

To shift down to a lower gear with the steering shift switches, pull the DOWN switch — toward you once with your fingers.

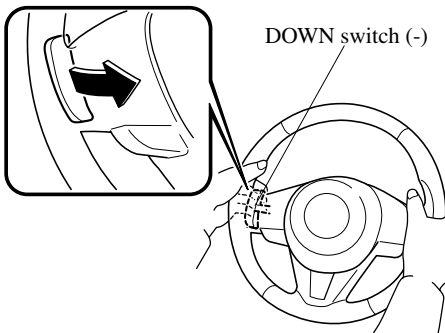

⚠ WARNING

Do not use engine braking on slippery road surfaces or at high speeds:

Shifting down while driving on wet, snowy, or frozen roads, or while driving at high speeds causes sudden engine braking, which is dangerous. The sudden change in tire speed could cause the tires to skid. This could lead to loss of vehicle control and an accident.

Keep your hands on the steering wheel rim when using fingers on the steering shift switches:

Putting your hands inside the rim of the steering wheel when using the steering shift switches is dangerous. If the driver's air bag were to deploy in a collision, your hands could be impacted causing injury.

NOTE

- *When driving at high speeds, the gear may not shift down.*
- *During deceleration, the gear may automatically shift down depending on vehicle speed.*
- *When depressing the accelerator fully, the transmission will shift to a lower gear, depending on vehicle speed. However, the gears do not kickdown while the DSC is turned off.*

Transmission

Second gear fixed mode

When the selector lever is moved back + while the vehicle speed is about 10 km/h (6.2 mph) or less, the transmission is set in the second gear fixed mode. The gear is fixed in second while in this mode for easier acceleration from a stop and driving on slippery roads such as snow-covered roads.

If the selector lever is moved back + or forward - while in the second gear fixed mode, the mode will be canceled.

Shift gear (shifting) speed limit

For each gear position while in the manual mode, the speed limit is set as follows: When the selector lever is operated within the range of the speed limit, the gear is shifted.

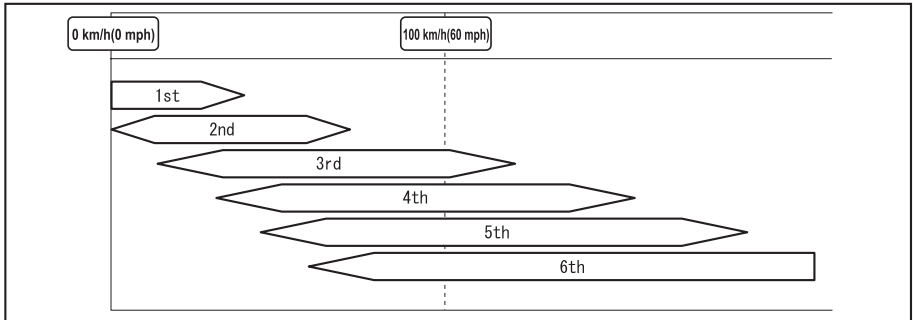

Shift up

The gear does not shift up while the vehicle speed is lower than the speed limit.

Shift down

The gear does not shift down while the vehicle speed exceeds the speed limit.

If the vehicle speed exceeds the speed limit and the gear does not shift down, the gear position indication flashes 2 times to notify the driver that the gear cannot be shifted.

Kickdown

When the accelerator pedal is depressed fully while driving, the gear shifts down. However, the gears do not kickdown while the DSC is turned off.

NOTE

The gear also shifts down using kickdown while in the second gear fixed mode.

Auto-shift down

The gear shifts down automatically depending on the vehicle speed during deceleration.

NOTE

If the vehicle comes to a stop while in the second gear fixed mode, the gear remains in second.

Transmission

Recommendations for shifting

Upshifting

For normal acceleration and cruising, Mazda recommends these shift points:

Gear	Vehicle speed*1
M1 to M2	24 km/h (15 mph)
M2 to M3	40 km/h (25 mph)
M3 to M4	65 km/h (40 mph)
M4 to M5	73 km/h (45 mph)
M5 to M6	81 km/h (50 mph)

*1 Always observe local speed limit regulations.

Downshifting

When you must slow down in heavy traffic or on a steep upgrade, downshift before the engine starts to overwork. This gives better acceleration when you need more speed.

On a steep downgrade, downshifting helps maintain safe speed and prolongs brake life.

▼ Direct Mode*

Direct mode can be used for temporarily switching gears by operating the steering shift switch while the vehicle is being driven with the selector lever in the D range.

While in direct mode, the D and M indication illuminate and the gear position in use is illuminated.

Direct mode is canceled (released) under the following conditions.

- The UP switch (+/OFF) is pulled rearward for a certain amount of time or longer.
- The vehicle is driven for a certain amount of time or longer (time differs depending on the driving conditions while operating).
- The vehicle is stopped or moving at a slow speed.

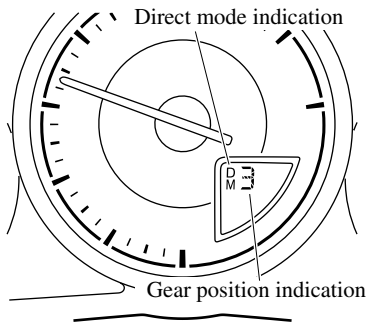
**NOTE**

Shifting up and down while in direct mode may not be possible depending on the vehicle speed. In addition, because direct mode is canceled (released) depending on the rate of acceleration or if the accelerator is fully depressed, use of the manual shift mode is recommended if you need to drive the vehicle in a particular gear for long periods.

▼ Driving Tips**⚠ WARNING**

Do not let the vehicle move in a direction opposite to the direction selected by the selector lever:

Do not let the vehicle move backward with the selector lever in a forward position, or do not let the vehicle move forward with the selector lever in the reverse position. Otherwise, the engine may stop, causing the loss of the power brake and power steering functions, and make it difficult to control the vehicle which could result in an accident.

Passing

For extra power when passing another vehicle or climbing steep grades, depress the accelerator fully. The transmission will shift to a lower gear, depending on vehicle speed.

Transmission

NOTE

- *The accelerator pedal may initially feel heavy as it is being depressed, then feel lighter as it is depressed further. This change in pedal force aids the engine control system in determining how much the accelerator pedal has been depressed for performing kickdown, and functions to control whether or not kickdown should be performed.*
- *While the selector lever is in the M position and the DSC is turned off, manual shift mode does not switch to automatic shift mode even if the accelerator pedal is completely depressed. Operate the selector lever.*

Climbing steep grades from a stop

To climb a steep grade from a stopped position:

1. Depress the brake pedal.
2. Shift to D or M1, depending on the load weight and grade steepness.
3. Release the brake pedal while gradually accelerating.

Descending steep grades

When descending a steep grade, shift to lower gears, depending on load weight and grade steepness. Descend slowly, using the brakes only occasionally to prevent them from overheating.

Lighting Control

▼ Headlights

Turn the headlight switch to turn the headlights, other exterior lights and dashboard illumination on or off.

When the lights are turned on, the lights-on indicator light in the instrument cluster turns on.



NOTE

- If the light switch is left on, the lights will automatically switch off approximately 30 seconds after switching the ignition off. The time setting can be changed. Refer to Personalization Features on page 9-9.
- To prevent discharging the battery, do not leave the lights on while the engine is off unless safety requires them.

Without auto-light control

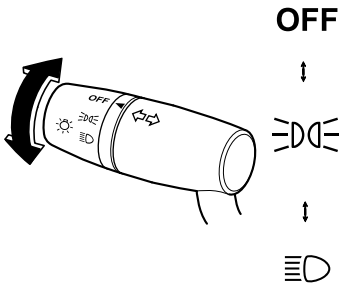

Switch Position	OFF		☞☐☞		☞☐	
Ignition Position	ON	ACC or OFF	ON	ACC or OFF	ON	ACC or OFF
Headlights	Off	Off	Off	Off	On	On* ²
Daytime running lights	On* ¹	Off	On* ¹	Off	Off	Off
Taillights Parking lights License lights Side-marker lights Dashboard illumination	Off	Off	On	On* ²	On	On* ²

*1 The lights are turned on while the vehicle is driven.

*2 The lights are turned on for the specified period by the auto headlight off function.

Switches and Controls

With auto-light control

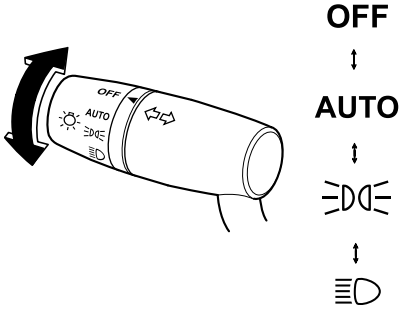

Switch Position	OFF		AUTO		☰☰☰		☰☰☰	
	ON	ACC or OFF	ON	ACC or OFF	ON	ACC or OFF	ON	ACC or OFF
Headlights	Off	Off	Auto* ²	Auto* ³	Off	Off	On	On* ⁵
Daytime running lights	On* ¹	Off	On* ⁴	Off	On* ¹	Off	Off	Off
Taillights Parking lights License lights Side-marker lights Dashboard illumination	Off	Off	Auto* ²	Auto* ³	On	On* ⁵	On	On* ⁵

*1 The lights are turned on while the vehicle is driven.

*2 The lights are turned on by the auto light function.

*3 The lights are turned on continuously if the ignition is switched from ON to any other position with the lights turned on. The lights are turned on for the specified period by the auto headlight off function.

*4 The lights are turned on while the vehicle is driven, and turned off when the headlights are turned on by the auto light function.

*5 The lights are turned on for the specified period by the auto headlight off function.

Auto-light control*

When the headlight switch is in the **AUTO** position and the ignition is switched ON, the light sensor senses the surrounding lightness or darkness and automatically turns the headlights, other exterior lights and dashboard illumination on or off.

⚠ CAUTION

- *Do not shade the light sensor by adhering a sticker or a label on the windshield. Otherwise the light sensor will not operate correctly.*

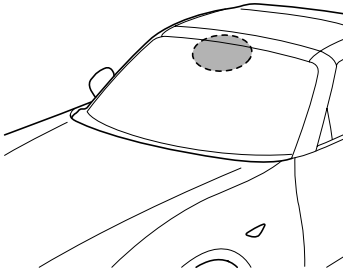

- *The light sensor also works as a rain sensor for the auto-wiper control. Keep hands and scrapers clear of the windshield when the wiper lever is in the **AUTO** position and the ignition is switched ON as fingers could be pinched or the wipers and wiper blades could be damaged when the wipers activate automatically. If you are going to clean the windshield, be sure the wipers are turned off completely when it is particularly tempting to leave the engine running. This is particularly important when clearing ice and snow.*

NOTE

- *The headlights, other exterior lights and dashboard illumination may not turn off immediately even if the surrounding area becomes well-lit because the light sensor determines that it is night time if the surrounding area is continuously dark for several minutes such as inside long tunnels, traffic jams inside tunnels, or in indoor parking lots. In this case, the lights turn off if the light switch is turned to the **OFF** position.*
- *The dashboard illumination can be adjusted by rotating the knob in the instrument cluster. Also, the day/night mode can be changed by rotating the knob until a beep sound is heard. To adjust the brightness of the dashboard illumination: Refer to Dashboard Illumination on page 4-15.*
- *The sensitivity of the auto-light control may be changed. Refer to Personalization Features on page 9-9.*

Switches and Controls

▼ Headlight High-Low Beam

The headlights switch between high and low beams by moving the lever forward or backward.

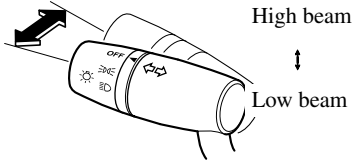

When the headlight high-beams are on, the headlight high-beam indicator light is turned on.



▼ Flashing the Headlights

Can be used when the ignition is switched ON.

To flash the headlights, pull the lever fully towards you (the headlight switch does not need to be on).

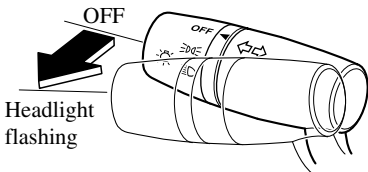

The headlight high-beam indicator light in the instrument cluster illuminates simultaneously. The lever will return to the normal position when released.



▼ Coming Home Light

The coming home light turns on the headlights (low beams) when the lever is operated.

To turn on the lights

When the lever is pulled with the ignition switched to ACC or OFF, the low beam headlights turn on.

The headlights turn off after a certain period of time has elapsed after the doors are closed.

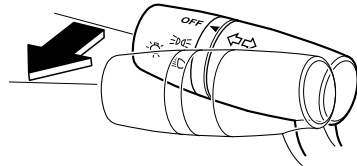

NOTE

- The time until the headlights turn off after all of the doors are closed can be changed. Refer to Personalization Features on page 9-9.
- If no operations are done for 3 minutes after the lever is pulled, the headlights turn off.
- The headlights turn off if the lever is pulled again while the headlights are illuminated.

▼ Leaving Home Light

The leaving home light turns on the lights when the transmitter unlock button is pressed while away from the vehicle. The following lights turn on when the leaving home light is operated. Low beams, Parking lights, Taillights, License lights.

To turn on the lights

When the ignition switch and the headlight switch are in the following conditions, the headlights will illuminate when the transmitter unlock button is pressed and the vehicle receives the transmitter signal. The headlights turn off after a certain period of time has elapsed (30 seconds).

- Ignition switch: off
- Headlight switch: ㊦ or ㊧

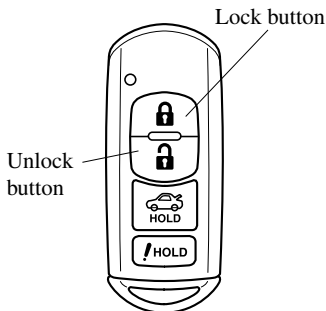

NOTE

- Operation of the leaving home light can be turned on or off. Refer to Personalization Features on page 9-9.
- When the transmitter lock button is pressed and the vehicle receives the transmitter signal, the headlights turn off.
- When the headlight switch is in a position other than ㊦ or ㊧, the headlights turn off.

▼ Headlight Leveling

The number of passengers and weight of cargo in the luggage compartment change the angle of the headlights.

The angle of the headlights will be automatically adjusted when turning on the headlights.

▼ Daytime Running Lights

Some countries require moving vehicles to have their lights on (daytime running lights) during the daytime.

The daytime running lights turn on automatically when the vehicle starts moving.

They turn off when the parking brake is operated or the shift lever is shifted to the P position (automatic transmission vehicle).

NOTE

(Except Canada)

The daytime running lights can be deactivated.

Refer to Personalization Features on page 9-9.

Switches and Controls

Turn and Lane-Change Signals

The ignition must be switched ON to use the turn and lane-change signals.

▼ Turn Signals

Move the signal lever down (for a left turn) or up (for a right turn) to the stop position. The signal will self-cancel after the turn is completed.

If the indicator light continues to flash after a turn, manually return the lever to its original position.

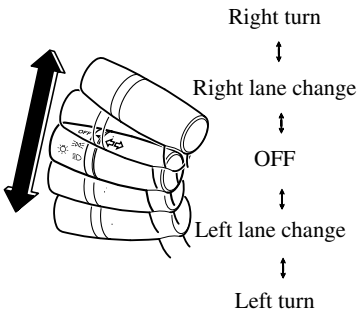

The turn signal indicators in the instrument cluster flash according to the operation of the turn signal lever to show which signal is working.



NOTE

- If an indicator light stays on without flashing or if it flashes abnormally, one of the turn signal bulbs may be burned out.
- A personalized function is available to change the turn indicator sound volume. (page 9-9)

▼ Lane-Change Signals

Move the lever halfway toward the direction of the lane change—until the indicator flashes—and hold it there. It will return to the off position when released.

▼ Three-Flash Turn Signal

After releasing the turn signal lever, the turn signal indicator flashes three times. The operation can be cancelled by moving the lever in the direction opposite to which it was operated.

NOTE

The three-flash turn signal function can be switched to operable/inoperable using the personalization function.

Refer to Personalization Features on page 9-9.

Windshield Wipers and Washer

The ignition must be switched ON to use the wipers.

WARNING

Use only windshield washer fluid or plain water in the reservoir:

Using radiator antifreeze as washer fluid is dangerous. If sprayed on the windshield, it will dirty the windshield, affect your visibility, and could result in an accident.

Only use windshield washer fluid mixed with anti-freeze protection in freezing weather conditions:

Using windshield washer fluid without anti-freeze protection in freezing weather conditions is dangerous as it could freeze on the windshield and block your vision which could cause an accident. In addition, make sure the windshield is sufficiently warmed using the defroster before spraying the washer fluid.

NOTE

If the windshield wipers are operated under cold weather conditions or during snowfall, they could stop due to accumulated snow on the windshield. If the windshield wipers stop due to accumulated snow on the windshield, park the vehicle in a safe place, turn the wiper switch off, and then remove the accumulated snow. If the wiper switch is turned to another position other than OFF, the wipers will operate. If the wipers do not operate even though the wiper switch is turned to a position other than OFF, consult an Authorized Mazda Dealer as soon as possible.

Switches and Controls

▼ Windshield Wipers

Turn the wipers on by pressing the lever up or down.

With intermittent wiper

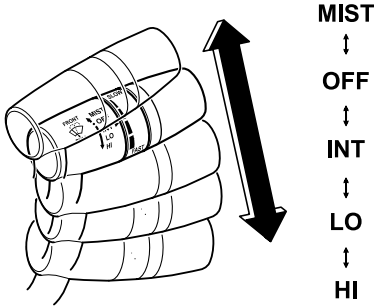

Switch Position	Wiper operation
MIST	Operation while pulling up lever
OFF	Stop
INT	Intermittent
LO	Low speed
HI	High speed

Variable-speed intermittent wipers

Set the lever to the intermittent position and choose the interval timing by rotating the ring.

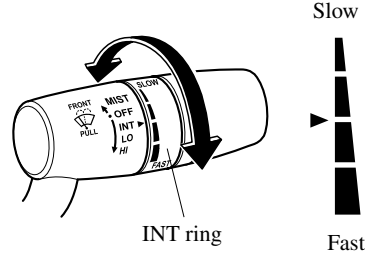

With auto-wiper control

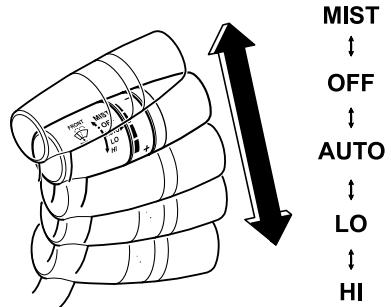

Switch Position	Wiper operation
MIST	Operation while pulling up lever
OFF	Stop
AUTO	Auto control
LO	Low speed
HI	High speed

Auto-wiper control

When the wiper lever is in the **AUTO** position, the rain sensor senses the amount of rainfall on the windshield and turns the wipers on or off automatically (off—intermittent—low speed—high speed).

The sensitivity of the rain sensor can be adjusted by turning the switch on the wiper lever.

From the center position (normal), rotate the switch upward for higher sensitivity (faster response) or rotate it downward for less sensitivity (slower response).

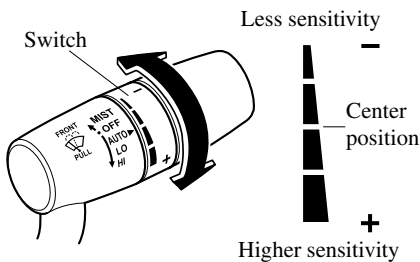

CAUTION

- Do not shade the rain sensor by adhering a sticker or a label on the windshield. Otherwise the rain sensor will not operate correctly.

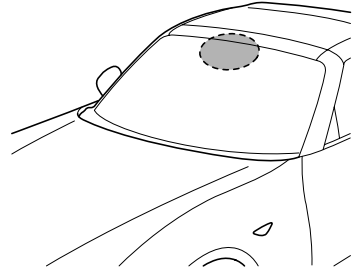

- When the wiper lever is in the **AUTO** position and the ignition is switched ON, the wipers may move automatically in the following cases:
 - If the windshield above the rain sensor is touched or wiped with a cloth.
 - If the windshield is struck with a hand or other object from either outside or inside the vehicle.

Keep hands and scrapers clear of the windshield when the wiper lever is in the **AUTO** position and the ignition is switched ON as fingers could be pinched or the wipers and wiper blades damaged when the wipers activate automatically. If you are going to clean the windshield, be sure the wipers are turned off completely (when it is most likely that the engine is left running) this is particularly important when clearing ice and snow.

Switches and Controls

NOTE

- Switching the auto-wiper lever from the **OFF** to the **AUTO** position while driving activates the windshield wipers once, after which they operate according to the rainfall amount.
- The auto-wiper control may not operate when the rain sensor temperature is about -10°C (14°F) or lower, or about 85°C (185°F) or higher.
- If the windshield is coated with water repellent, the rain sensor may not be able to sense the amount of rainfall correctly and the auto-wiper control may not operate properly.
- If dirt or foreign matter (such as ice or matter containing salt water) adheres to the windshield above the rain sensor, or if the windshield is iced, it could cause the wipers to move automatically. However, if the wipers cannot remove this ice, dirt or foreign matter, the auto-wiper control will stop operation. In this case, set the wiper lever to the low speed position or high speed position for manual operation, or remove the ice, dirt or foreign matter by hand to restore the auto-wiper operation.
- If the auto-wiper lever is left in the **AUTO** position, the wipers could operate automatically from the effect of strong light sources, electromagnetic waves, or infrared light because the rain sensor uses an optical sensor. It is recommended that the auto-wiper lever be switched to the **OFF** position other than when driving the vehicle under rainy conditions.
- The auto-wiper control functions can be turned off. Refer to Personalization Features on page 9-9.

▼ Windshield Washer

Pull the lever toward you and hold it to spray washer fluid.

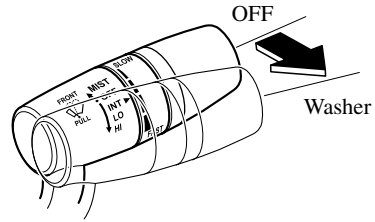

NOTE

If the windshield washer is turned on when the windshield wipers are not operating, the windshield wipers operate a few times.

If the washer does not work, inspect the fluid level (page 6-31). If the fluid level is normal, consult an Authorized Mazda Dealer.

Rear Window Defogger

The rear window defogger clears fog from the rear window.

The ignition must be switched ON to use the defogger.

Press the switch to turn on the rear window defogger. The rear window defogger operates for about 15 minutes and then turns off automatically. The indicator light illuminates when the defogger is operating.

To turn off the rear window defogger before the 15 minutes has elapsed, press the switch again.

Manual Climate Control

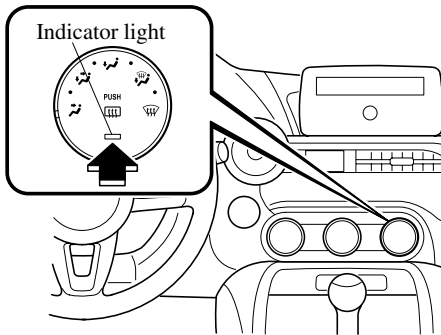

Fully Automatic Climate Control

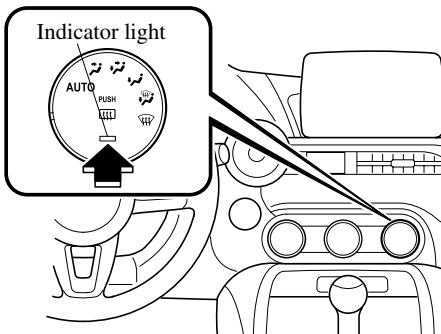

CAUTION

- > Do not use sharp instruments or window cleaners with abrasives to clean the inside of the rear window surface. They may damage the defogger grid inside the window.
- > Before opening the convertible top, make sure the rear window defogger switch is turned off. Otherwise the heat generated from the defogger could damage the convertible top and the internal material.

NOTE

This defogger is not designed for melting snow. If there is an accumulation of snow on the rear window, remove it before using the defogger.

Switches and Controls

▼ Mirror Defogger*

The mirror defoggers defrost the outside mirrors.

The mirror defoggers operate in conjunction with the rear window defogger.

To turn on the mirror defoggers, switch the ignition ON and press the rear window defogger switch (page 4-55).

Manual Climate Control

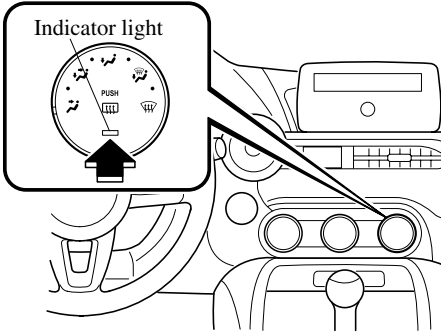

Fully Automatic Climate Control

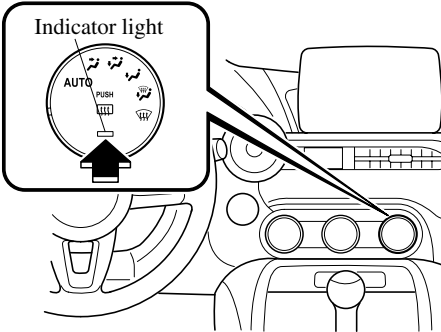

Horn

To sound the horn, press the  mark on the steering wheel.

Hazard Warning Flasher

The hazard warning lights should always be used when you stop on or near a roadway in an emergency.

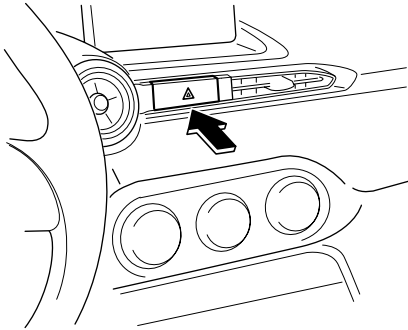

The hazard warning lights warn other drivers that your vehicle is a traffic hazard and that they must take extreme caution when near it.



Depress the hazard warning flasher and all the turn signals will flash. The hazard warning indicator lights in the instrument cluster flash simultaneously.

NOTE

- *The turn signals do not work when the hazard warning lights are on.*
- *Check local regulations about the use of hazard warning lights while the vehicle is being towed to verify that it is not in violation of the law.*

HomeLink Wireless Control System*

NOTE

HomeLink and HomeLink house icon are registered trademarks of Gentex Corporation.

The HomeLink system replaces up to 3 hand-held transmitters with a single built-in component in the auto-dimming mirror. Pressing the HomeLink button on the auto-dimming mirror activates garage doors, gates and other devices surrounding your home.

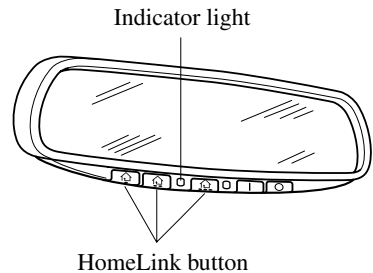

Switches and Controls

WARNING

Do not use the HomeLink system with any garage door opener that lacks the safety stop and reverse feature:

Using the HomeLink system with any garage door opener that lacks the safety stop and reverse feature as required by federal safety standards is dangerous. (This includes garage doors manufactured before April 1, 1982.)

Using these garage door openers can increase the risk of serious injury or death. For further information, contact HomeLink at 1-800-355-3515 or www.homelink.com or an Authorized Mazda Dealer.

Always check the areas surrounding garage doors and gates for people or obstructions before programming or during operation of the HomeLink system:

Programming or operating the HomeLink system without verifying the safety of areas surrounding garage doors and gates is dangerous and could result in an unexpected accident and serious injury if someone were to be hit.

NOTE

The programming will not be erased even if the battery is disconnected.

▼ **Pre-programming the HomeLink System**

NOTE

It is recommended that a new battery be placed in the hand-held transmitter of the device being programmed to HomeLink for quicker training and accurate transmission of the radio-frequency signal.

- Verify that there is a remote control transmitter available for the device you would like to program.
- Disconnect the power to the device.

▼ **Programming the HomeLink System**

CAUTION

When programming a garage door opener or a gate, disconnect the power to these devices before performing programming. Continuous operation of the devices could damage the motor.

The HomeLink system provides 3 buttons which can be individually selected and programmed using the transmitters for current, on-market devices as follows:

1. Disconnect the power to the garage door opener or gate programmed to the hand-held transmitter.
2. Position the end of your hand-held transmitter 2.5—7.5 cm (1—3 inches) away from the HomeLink button you wish to program while keeping the indicator light in view.

3. Simultaneously press and hold both the chosen HomeLink and hand-held transmitter buttons. **Do not release the buttons until step 3 has been completed.**

NOTE

Some gate operators and garage door openers may require you to replace this Programming Step 2 with procedures noted in the “Gate Operator/Canadian Programming” section.

4. After the HomeLink indicator light changes from a slow to a rapidly blinking light, release both the HomeLink and hand-held transmitter buttons.

NOTE

If the HomeLink indicator light does not change to a rapidly blinking light, contact HomeLink at www.homelink.com or call 1-800-355-3515 for assistance.

5. Connect the power to the garage door opener or gate programmed to the hand-held transmitter.

6. Firmly press and hold the programmed HomeLink button for five seconds, and then release it. Perform this operation two times to activate the door or gate. If the door or gate does not activate, press and hold the just-trained HomeLink button and observe the indicator light.

If the indicator light stays on constantly, programming is complete and your device should activate when the HomeLink button is pressed and released.

NOTE

To program the remaining two HomeLink buttons, begin with “Programming”—step 1

If the indicator light blinks **rapidly for two seconds and then turns to a constant light, continue with “Programming” steps 7—9** to complete the programming of a rolling code equipped device (most commonly a garage door opener).

7. At the garage door opener receiver (motor-head unit) in the garage, locate the “learn” or “smart” button. This can usually be found where the hanging antenna wire is attached to the motor-head unit.
8. Firmly press and release the “learn” or “smart” button. (The name and color of the button may vary by manufacturer.)

NOTE

Complete the programming within 30 seconds.

Switches and Controls

- Return to the vehicle and firmly **press, hold for two seconds and release** the programmed HomeLink button. Repeat the “**press/hold/release**” sequence a second time, and, depending on the brand of the garage door opener (or other rolling code equipped device), repeat this sequence a third time to complete the programming process.

HomeLink should now activate your rolling code equipped device.

NOTE

To program the remaining two HomeLink buttons, begin with “Programming”—step 1

For questions or comments, please contact HomeLink at www.homelink.com or **1-800-355-3515**.

▼ **Gate operator/Canadian Programming**

Canadian radio-frequency laws require transmitter signals to “time-out” (or quit) after several seconds of transmission — which may not be long enough for HomeLink to pick up the signal during programming. Similar to this Canadian law, some U.S. gate operators are designed to “time-out” in the same manner.

If you live in Canada or you are having difficulties programming a gate operator by using the “Programming” procedures (regardless of where you live), **replace “Programming HomeLink” step 3** with the following:

NOTE

If programming a garage door opener or gate operator, it is advised to unplug the device during the “cycling” process to prevent possible overheating.

Continue to press and hold the HomeLink button while you **press and release** — **every two seconds** (“cycle”) your hand-held transmitter until the frequency signal has successfully been accepted by HomeLink. (The indicator light will flash slowly and then rapidly.) Proceed with “Programming” step 4 to complete.

▼ **Operating the HomeLink System**



Press the programmed HomeLink button to operate a programmed device. The code will continue being transmitted for a maximum of 20 seconds.

▼ **Reprogramming the HomeLink system**

To program a device to HomeLink using a HomeLink button previously trained, follow these steps:

- Press and hold the desired HomeLink button. **DO NOT** release the button.
- The indicator light will begin to flash after 20 seconds. Without releasing the HomeLink button, proceed with “Programming” - step 1.

▼ **Erasing Programmed HomeLink Buttons**

To erase the existing programming from all three operating channels, press and hold the two outside buttons (, ) on the auto-dimming mirror until the HomeLink indicator light begins to flash after approximately 10 seconds. Verify that the programming has been erased when you resell the vehicle.

Brake System

▼ Foot Brake

This vehicle has power-assisted brakes that adjust automatically through normal use.

Should power-assist fail, you can stop by applying greater force than normal to the brake pedal. But the distance required to stop will be greater than usual.

! WARNING

Do not coast with the engine stalled or turned off, find a safe place to stop:

Coasting with the engine stalled or turned off is dangerous. Braking will require more effort, and the brake's power-assist could be depleted if you pump the brake. This will cause longer stopping distances or even an accident.

Shift to a lower gear when going down steep hills:

Driving with your foot continuously on the brake pedal or steadily applying the brakes for long distances is dangerous. This causes overheated brakes, resulting in longer stopping distances or even total brake failure. This could cause loss of vehicle control and a serious accident. Avoid continuous application of the brakes.

Dry off brakes that have become wet by driving slowly, releasing the accelerator pedal and lightly applying the brakes several times until the brake performance returns to normal:

Driving with wet brakes is dangerous. Increased stopping distance or the vehicle pulling to one side when braking could result in a serious accident. Light braking will indicate whether the brakes have been affected.

! CAUTION

- Do not drive with your foot held on the clutch pedal or brake pedal, or hold the clutch pedal depressed halfway unnecessarily. Doing so could result in the following:
 - The clutch and brake parts will wear out more quickly.
 - The brakes can overheat and adversely affect brake performance.
- Always depress the brake pedal with the right foot. Applying the brakes with the unaccustomed left foot could slow your reaction time to an emergency situation resulting in insufficient braking operation.

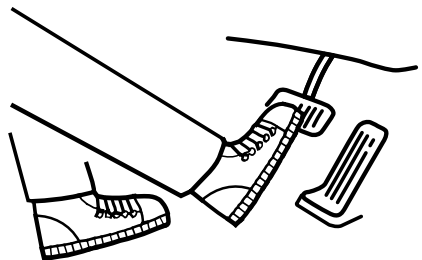

- Wear shoes appropriate for driving in order to avoid your shoe contacting the brake pedal when depressing the accelerator pedal.

Brake

▼ Parking Brake



Driving with the parking brake on will cause excessive wear of the brake parts.

NOTE

For parking in snow, refer to Winter Driving (page 3-53) regarding parking brake use.

Setting the parking brake

Depress the brake pedal and then firmly pull the parking brake lever fully upwards with sufficient force to hold the vehicle in a stationary position.

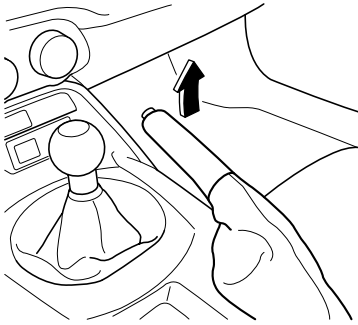

Releasing the parking brake

Depress the brake pedal and pull the parking brake lever upwards, then press the release button. While holding the button, lower the parking brake lever all the way down to the released position.

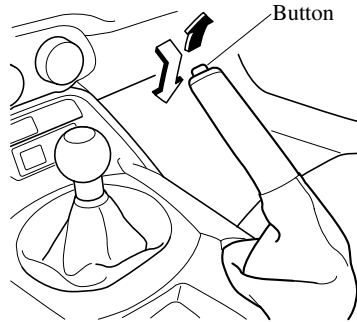

▼ Warning Light

The warning light turns on when the system has a malfunction. Refer to Warning Lights on page 4-26.

▼ Brake Pad Wear Indicator

When the disc brake pads become worn, the built-in wear indicators contact the disc plates. This causes a screeching noise to warn that the pads should be replaced.

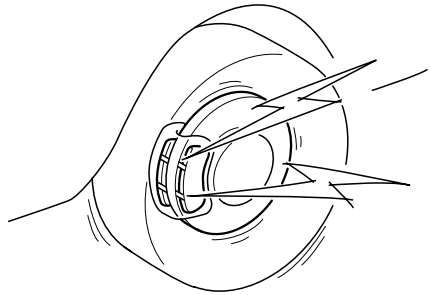

When you hear this noise, consult an Authorized Mazda Dealer as soon as possible.

⚠ WARNING**Do not drive with worn disc pads:**

Driving with worn disc pads is dangerous. The brakes could fail and cause a serious accident. As soon as you hear a screeching noise consult an Authorized Mazda Dealer.

▼ Brake Assist

During emergency braking situations when it is necessary to depress the brake pedal with greater force, the brake assist system provides braking assistance, thus enhancing braking performance.

When the brake pedal is depressed hard or depressed more quickly, the brakes apply more firmly.

NOTE

- *When the brake pedal is depressed hard or depressed more quickly, the pedal will feel softer but the brakes will apply more firmly. This is a normal effect of the brake assist operation and does not indicate a malfunction.*
- *When the brake pedal is depressed hard or depressed more quickly, a motor/pump operation noise may be heard. This is a normal effect of the brake assist and does not indicate a malfunction.*
- *The brake assist equipment does not supersede the functionality of the vehicle's main braking system.*

Hill Launch Assist (HLA)*

Hill Launch Assist (HLA) is a function which assists the driver in accelerating from a stop while on a slope. When the driver releases the brake pedal and depresses the accelerator pedal while on a slope, the function prevents the vehicle from rolling. The braking force is maintained automatically after the brake pedal is released on a steep grade.

For vehicles with a manual transmission, Hill Launch Assist (HLA) operates on a downward slope when the shift lever is in the reverse (R) position, and on an upward slope when the shift lever is in a position other than the reverse (R) position.

For vehicles with an automatic transmission, Hill Launch Assist (HLA) operates on a downward slope when the selector lever is in the reverse (R) position, and on an upward slope when the selector lever is in a forward gear.

WARNING

Do not rely completely on Hill Launch Assist (HLA):

Hill Launch Assist (HLA) is an auxiliary device for accelerating from a stop on a slope. The system only operates for about two seconds and therefore, relying only on the system, when accelerating from a stop is dangerous because the vehicle may move (roll) unexpectedly and cause an accident. The vehicle could roll depending on the vehicle's load or if it is towing something. In addition, for vehicles with a manual transmission, the vehicle could still roll depending on how the clutch pedal or the accelerator pedal is operated. Always confirm the safety around the vehicle before starting to drive the vehicle.

NOTE

- Hill Launch Assist (HLA) does not operate on a gentle slope. In addition, the gradient of the slope on which the system will operate changes depending on the vehicle's load.
- Hill Launch Assist (HLA) does not operate if the parking brake is applied, the vehicle has not stopped completely, or the clutch pedal is released.
- While Hill Launch Assist (HLA) is operating, the brake pedal may feel stiff and vibrate, however, this does not indicate a malfunction.
- Hill Launch Assist (HLA) does not operate while the TCS/DSC indicator light is illuminated. Refer to Warning/Indicator Lights on page 4-26.
- Hill Launch Assist (HLA) does not turn off even if the DSC OFF switch is pressed to turn off the TCS/DSC.

Antilock Brake System (ABS)

The ABS control unit continuously monitors the speed of each wheel. If one wheel is about to lock up, the ABS responds by automatically releasing and reapplying that wheel's brake.

The driver will feel a slight vibration in the brake pedal and may hear a chattering noise from the brake system. This is normal ABS system operation. Continue to depress the brake pedal without pumping the brakes.

The warning light turns on when the system has a malfunction. Refer to Warning Indication/Warning Lights on page 4-26.

WARNING

Do not rely on ABS as a substitute for safe driving:

The ABS cannot compensate for unsafe and reckless driving, excessive speed, tailgating (following another vehicle too closely), driving on ice and snow, and hydroplaning (reduced tire friction and road contact because of water on the road surface). You can still have an accident.

NOTE

- *Braking distances may be longer on loose surfaces (snow or gravel, for example) which usually have a hard foundation. A vehicle with a normal braking system may require less distance to stop under these conditions because the tires will build up a wedge of surface layer when the wheels skid.*
- *The sound of the ABS operating may be heard when starting the engine or immediately after starting the vehicle, however, it does not indicate a malfunction.*

Traction Control System (TCS)

The Traction Control System (TCS) enhances traction and safety by controlling engine torque and braking. When the TCS detects driving wheel slippage, it lowers engine torque and operates the brakes to prevent loss of traction.

This means that on a slick surface, the engine adjusts automatically to provide optimum power to the drive wheels, limiting wheel spin and loss of traction.

The warning light turns on when the system has a malfunction. Refer to Warning Indication/Warning Lights on page 4-26.

WARNING

Do not rely on the Traction Control System (TCS) as a substitute for safe driving:

The Traction Control System (TCS) cannot compensate for unsafe and reckless driving, excessive speed, tailgating (following another vehicle too closely), and hydroplaning (reduced tire friction and road contact because of water on the road surface). You can still have an accident.

Use snow tires or tire chains and drive at reduced speeds when roads are covered with ice and/or snow:

Driving without proper traction devices on snow and/or ice-covered roads is dangerous. The Traction Control System (TCS) alone cannot provide adequate traction and you could still have an accident.

NOTE

To turn off the TCS, press the DSC OFF switch (page 4-68).

▼ TCS/DSC Indicator Light



This indicator light stays on for a few seconds when the ignition is switched ON. If the TCS or DSC is operating, the indicator light flashes.

If the light stays on, the TCS, DSC or the brake assist system may have a malfunction and they may not operate correctly. Take your vehicle to an Authorized Mazda Dealer.

NOTE

- *In addition to the indicator light flashing, a slight lugging sound will come from the engine. This indicates that the TCS/DSC is operating properly.*
- *On slippery surfaces, such as fresh snow, it will be impossible to achieve high rpm when the TCS is on.*

Dynamic Stability Control (DSC)

The Dynamic Stability Control (DSC) automatically controls braking and engine torque in conjunction with systems such as ABS and TCS to help control side slip when driving on slippery surfaces, or during sudden or evasive maneuvering, enhancing vehicle safety.

Refer to ABS (page 4-65) and TCS (page 4-66).

DSC operation is possible at speeds greater than 20 km/h (12 mph).

The warning light turns on when the system has a malfunction. Refer to Warning Indication/Warning Lights on page 4-26.

WARNING

Do not rely on the Dynamic Stability Control as a substitute for safe driving:

The Dynamic Stability Control (DSC) cannot compensate for unsafe and reckless driving, excessive speed, tailgating (following another vehicle too closely), and hydroplaning (reduced tire friction and road contact because of water on the road surface). You can still have an accident.

CAUTION

- *The DSC may not operate correctly unless the following are observed:*
 - *Use tires of the correct size specified for your Mazda on all four wheels.*
 - *Use tires of the same manufacturer, brand and tread pattern on all four wheels.*
 - *Do not mix worn tires.*
- *The DSC may not operate correctly when tire chains are used or a temporary spare tire is installed because the tire diameter changes.*

▼ **TCS/DSC Indicator Light**



This indicator light stays on for a few seconds when the ignition is switched ON. If the TCS or DSC is operating, the indicator light flashes.

If the light stays on, the TCS, DSC or the brake assist system may have a malfunction and they may not operate correctly. Take your vehicle to an Authorized Mazda Dealer.

▼DSC OFF Indicator Light



This indicator light stays on for a few seconds when the ignition is switched ON. It also illuminates when the DSC OFF switch is pressed and TCS/DSC is switched off.

Refer to DSC OFF Switch on page 4-68.

If the light remains illuminated and the TCS/DSC is not switched off, take your vehicle to an Authorized Mazda Dealer. The DSC may have a malfunction.

▼DSC OFF Switch

Press the DSC OFF switch to turn off the TCS/DSC. The DSC OFF indicator light in the instrument cluster will illuminate.

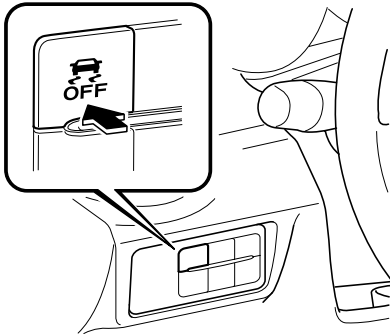

Press the switch again to turn the TCS/DSC back on. The DSC OFF indicator light will turn off.

NOTE

- When DSC is on and you attempt to free the vehicle when it is stuck, or drive it out of freshly fallen snow, the TCS (part of the DSC system) will activate. Depressing the accelerator will not increase engine power and freeing the vehicle may be difficult. When this happens, turn off the TCS/DSC.
- If the TCS/DSC is off when the engine is turned off, it automatically activates when the ignition is switched ON.
- Leaving the TCS/DSC on will provide the best traction.
- If the DSC OFF switch is pressed and held for 10 seconds or more, the DSC OFF switch malfunction detection function operates and the DSC system activates automatically. The DSC OFF indicator light turns off while the DSC system is operative.

Fuel Economy Monitor*

For vehicles with type B audio, the Fuel Consumption information is displayed by operating each icon in the display.

In addition, after completing a trip, the total energy efficiency to date is displayed in the ending display when the ending display is turned on.

1. Select the  icon on the home screen to display the applications screen.
2. Select the “Fuel Economy Monitor”.
3. Operate the commander switch or touch the screen and display the menu.

NOTE

When the menu is displayed by touching the screen, the display is hidden automatically after 6 seconds.

4. Select the icon in the menu and perform the operation. Each icon operates as follows:

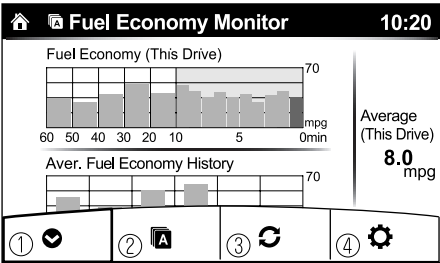
Indication on display	Control status
	<ol style="list-style-type: none"> ① Hides the menu display. ② Displays the application screen. ③ Resets the fuel economy data. ④ Displays the following setting screen. <ul style="list-style-type: none"> •Ending display on/off switching •On/off switching for function which synchronizes reset fuel economy data to trip meter (Trip A)

Fuel Economy Monitor

▼ Fuel Consumption Display

Information regarding the fuel economy is displayed.

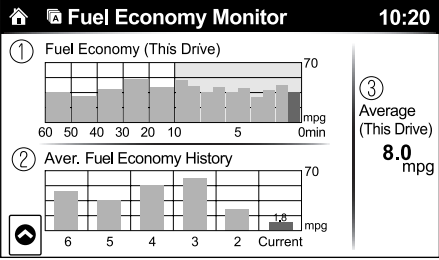
Indication on display	Control status
 <p>① Fuel Economy (This Drive)</p> <p>② Aver. Fuel Economy History</p> <p>③ Average (This Drive) 8.0 mpg</p>	<p>① Displays the fuel economy for the past 60 minutes.</p> <ul style="list-style-type: none"> • Displays the fuel economy every minute for the past 1 to 10 minutes. • Displays the fuel economy every 10 minutes for the past 10 to 60 minutes.
	<p>② Displays the average fuel economy over the past 5 resets and after the current reset.</p>
	<p>③ Calculates the average fuel economy every minute after vehicle travel begins, and displays it.</p>

NOTE

- The fuel economy data can be reset by doing the following operation:
 - Press the reset switch from the menu screen.
 - When the function which synchronizes the fuel economy monitor and the trip meter is on, reset trip A of the trip meter.
 - Delete the average fuel economy information displayed in the trip computer.
- After resetting the fuel economy data, "--" is displayed while the average fuel economy is calculated.

▼ Ending Screen Display

If the ending display on the fuel economy monitor is on when the ignition is switched from ON to OFF, the information regarding the fuel economy is displayed.

Drive Selection*

Drive selection is a system to switch the vehicle's drive mode. When the sport mode is selected, vehicle's response against accelerator operation is enhanced. This provides additional quick acceleration which may be needed to safely make maneuvers such as lane changes, merging onto freeways, or passing other vehicles.

CAUTION

Do not use the sport mode when driving on slippery roads such as wet or snow-covered roads. It may cause tire slipping.

NOTE

- *When the sport mode is selected, driving at higher engine speeds increases and it may increase fuel consumption. Mazda recommends that you cancel the sport mode on normal driving.*
- *Drive mode cannot be switched in the following conditions:*
 - *ABS/TCS/DSC is operating*
 - *Cruise control is operating.*
 - *Steering wheel is being operated abruptly*

Drive Selection

▼ Drive Selection Switch

Press the drive selection switch forward (“SPORT”) to select the sport mode.
Pull the drive selection switch back (“—”) to cancel the sport mode.

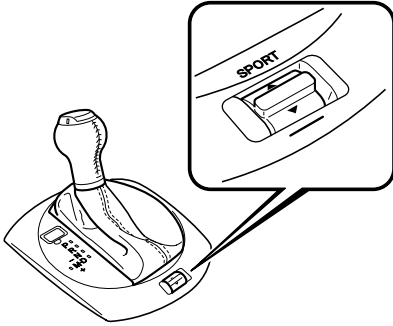

NOTE

- When the ignition is switched off, the sport mode is canceled.
- Depending on the driving conditions when sport mode is selected, the vehicle may perform shift-down or slightly accelerate.

▼ Select Mode Indication

When the sport mode is selected, the select mode indication turns on in the instrument cluster.

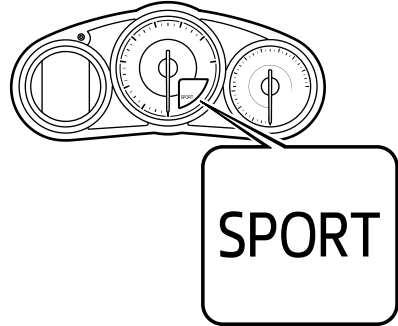

NOTE

If the drive selection cannot be switched to sport mode, the select mode indication flashes to notify the driver.

Power Steering

- Power steering is only operable when the engine is running. If the engine is off or if the power steering system is inoperable, you can still steer, but it requires more physical effort. If the steering feels stiffer than usual during normal driving or the steering vibrates, consult an Authorized Mazda Dealer.
- The warning light notifies the driver of system abnormalities and operation conditions. Refer to Warning Indication/Warning Lights on page 4-26.

CAUTION

Never hold the steering wheel to the extreme left or right for more than 5 seconds with the engine running. This could damage the power steering system.

i-ACTIVSENSE*

i-ACTIVSENSE is a collective term covering a series of advanced safety and driver support systems which make use of a Forward Sensing Camera (FSC) and radar sensors.

Because each system has its limitations, always drive carefully and do not rely solely on the systems.

Driver awareness support systems**Nighttime visibility**

Adaptive Front Lighting System (AFS).....	4-75
High Beam Control System (HBC)	4-76

Left/right side and rear side detection

Lane Departure Warning System (LDWS)	4-79
Blind Spot Monitoring (BSM) System	4-85

Rear obstruction detection when leaving a parking space

Rear Cross Traffic Alert (RCTA)	4-92
---------------------------------------	------

▼ Camera and Sensors**Forward sensing camera (FSC)**

The Forward Sensing Camera (FSC) determines the conditions ahead of the vehicle while traveling at night and detects traffic lanes. The following systems also use the Forward Sensing Camera (FSC).

- High Beam Control system (HBC)
- Lane Departure Warning System (LDWS)

The Forward Sensing Camera (FSC) is installed at the top of the windshield near the rearview mirror.

Refer to Forward Sensing Camera (FSC) on page 4-95.

Radar sensors (rear)

The radar sensors (rear) function by detecting the radio waves reflected off a vehicle approaching from the rear or an obstruction sent from the radar sensors. The following systems also use the radar sensors (rear).

- Blind Spot Monitoring (BSM) System
- Rear Cross Traffic Alert (RCTA)

The radar sensors (rear) are installed inside the rear bumper, one each on the left and right sides.

Refer to Radar Sensors (Rear) on page 4-98.

Adaptive Front Lighting System (AFS)*

The adaptive front lighting system (AFS) automatically adjusts the headlight beams to the left or right in conjunction with the operation of the steering wheel after the headlights have been turned on.

A system malfunction or operation conditions are indicated by a warning.
Refer to Warning/Indicator Lights on page 4-26.

NOTE

The Adaptive Front Lighting System (AFS) function can be switched to operable/inoperable using the personalization function.

Refer to Personalization Features on page 9-9.

High Beam Control System (HBC)*

The High Beam Control System (HBC) determines the conditions in front of the vehicle using the Forward Sensing Camera (FSC) while driving in darkness to automatically switch the headlights between high and low beams.

Refer to Warning/Indicator Lights on page 4-18.

While driving the vehicle at a speed of about 30 km/h (19 mph) or more, the headlights are switched to high beams when there are no vehicles ahead or approaching in the opposite direction.

The system switches the headlights to low beams when one of the following occurs:

- The system detects a vehicle or the headlights/lights of a vehicle approaching in the opposite direction.
- The vehicle is driven on roads lined with streetlamps or on roads in well-lit cities and towns.
- The vehicle is driven at less than about 20 km/h (12 mph).

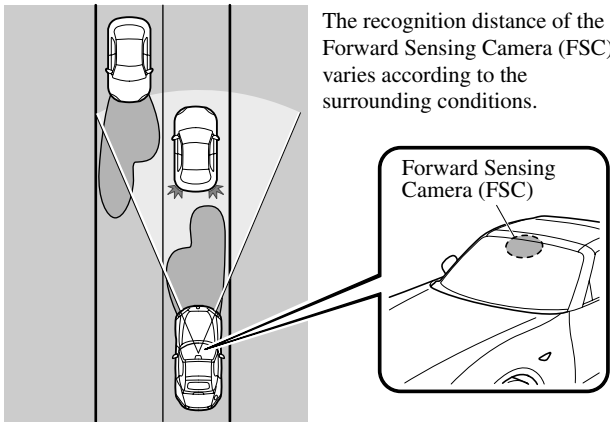

The recognition distance of the Forward Sensing Camera (FSC) varies according to the surrounding conditions.

The warning light turns on when the system has a malfunction.

Refer to Warning Indication/Warning Lights on page 4-26.

CAUTION

- Do not adjust the vehicle height, modify the headlight units, or remove the camera, otherwise the system will not operate normally.
- Do not rely excessively on the High Beam Control System (HBC) and drive the vehicle while paying sufficient attention to safety. Switch the headlights between the high beams and low beams manually if necessary.

NOTE

The timing in which the system switches the headlights changes under the following conditions. If the system does not switch the headlights appropriately, manually switch between high and low beams according to the visibility as well as road and traffic conditions.

- *When there are sources of light in the area such as street lamps, illuminated signboards, and traffic signals.*
- *When there are reflective objects in the surrounding area such as reflective plates and signs.*
- *When visibility is reduced under rain, snow and foggy conditions.*
- *When driving on roads with sharp turn or hilly terrain.*
- *When the headlights/rear lamps of vehicles in front of you or in the opposite lane are dim or not illuminated.*
- *When there is sufficient darkness such as at dawn or dusk.*
- *When the luggage compartment is loaded with heavy objects.*
- *When visibility is reduced due to a vehicle in front of you spraying water from its tires onto your windshield.*

▼ To Operate the System

The High Beam Control System (HBC) operates to switch the headlights automatically between high and low beams after the ignition is switched ON and the headlight switch is in the AUTO and high beam position.

The High Beam Control System (HBC) determines that it is dark based on the brightness of the surrounding area. At the same time, the High Beam Control System (HBC) indicator light (green) in the instrument cluster illuminates.



NOTE

- *When the vehicle speed is about 30 km/h (19 mph) or more, the headlights automatically switch to high beams when there are no vehicles ahead or approaching in the opposite direction. When the vehicle speed is less than about 20 km/h (12 mph), the High Beam Control System (HBC) switches the headlights to low beams.*
- *The low beams may not switch to high beams when cornering.*
- *Operation of the High Beam Control System (HBC) function can be disabled. Refer to Personalization Features on page 9-9.*

▼ Manual Switching

Switching to low beams

Shift the lever to the low beam position. The High Beam Control System (HBC) indicator light (green) turns off.

Switching to high beams

Turn the headlight switch to the $\equiv \text{D}$ position.

The High Beam Control System (HBC) indicator light (green) turns off and the $\equiv \text{D}$ is illuminated.

Lane Departure Warning System (LDWS)*

The LDWS system notifies the driver that the vehicle may be deviating from its lane. The system detects the white or yellow lines on the traffic lane using the Forward Sensing Camera (FSC) and if it determines that the vehicle may be deviating from its lane, it notifies the driver by flashing the LDWS warning light and activating the LDWS warning beep, and by the multi-information display (vehicles with multi-information display). Use the LDWS when you drive the vehicle on roads with white or yellow lines. Refer to Forward Sensing Camera on page 4-95.

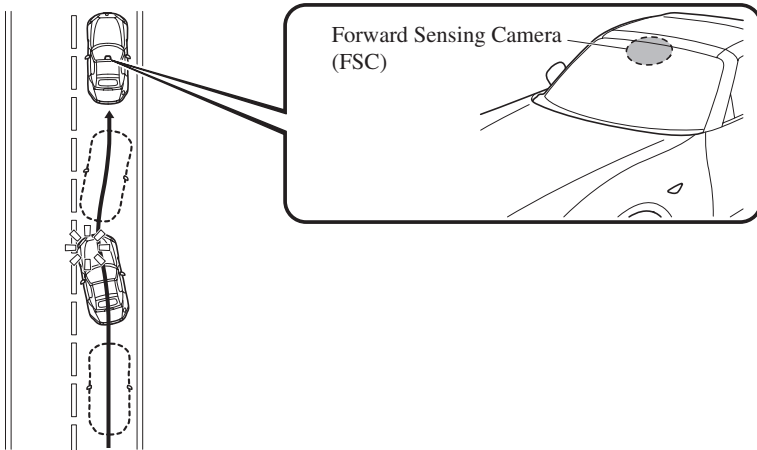

The warning light illuminates when the system has a malfunction. Refer to Warning Indication/Warning Lights on page 4-26.

! WARNING

Do not use the LDWS under the following conditions:

The system may not operate adequately according to the actual driving conditions, resulting in an accident.

- *Driving on roads with tight curves.*
- *Driving under bad weather conditions (rain, fog, and snow).*

The functions of the LDWS have limitations:

Always stay on course using the steering wheel and drive with care. The system is not designed to compensate for a driver's lack of caution and if you rely too much on the LDWS it could lead to an accident. The driver is responsible for assuring lane changes and other maneuvers. Always pay attention to the direction in which the vehicle is traveling and the vehicle's surroundings.

⚠ CAUTION

Do not modify the suspension. If the vehicle height or the damping force of the suspensions is changed, the LDWS may not operate correctly.

NOTE

- *If your vehicle deviates from its traffic lane, the LDWS operates (warning sound and indicator light). Steer the vehicle adequately to drive the vehicle to the center of the lane.*
- *When the turn signal lever is operated for a lane change, the LDWS warning is automatically canceled. The LDWS warning becomes operable when the turn signal lever is returned and the system detects the white or yellow lines.*
- *If the steering wheel, accelerator pedal, or brake pedal is operated abruptly and the vehicle moves close to a white or yellow line, the system determines that the driver is making a lane change and the LDWS warning is automatically canceled.*
- *The LDWS may not operate during the period immediately after the vehicle has deviated from its lane and the LDWS has operated, or the vehicle deviates from its lane repeatedly within a short period of time.*
- *The LDWS does not operate if it does not detect the white or yellow lines of the traffic lane.*

- *Under the following conditions, the LDWS may not be able to detect white or yellow lines correctly and the LDWS may not operate correctly.*
 - *If an object placed on the dashboard is reflected in the windshield and picked up by the camera.*
 - *Heavy luggage is loaded in the luggage compartment the vehicle is inclined.*
 - *The tire pressures are not adjusted to the specified pressure.*
 - *When the vehicle is driven on the entry and exit to or from the rest area or tollgate of a highway.*
 - *The white or yellow lines are less visible because of dirt or paint flaking.*
 - *The vehicle ahead is running near a white or yellow line and the line is less visible.*
 - *A white or yellow line is less visible because of bad weather (rain, fog, or snow).*
 - *The vehicle is driven on a temporary lane or section with a closed lane due to construction.*
 - *A misleading line is picked up on the road such as a temporary line for construction, or because of shade, lingering snow, or grooves filled with water.*
 - *The surrounding brightness suddenly changes such as when entering or exiting a tunnel.*
 - *The illumination of the headlights is weakened because of dirt or the optical axis is deviated.*
 - *The windshield is dirty or foggy.*
 - *Back-light is reflecting from the road surface.*
 - *The road surface is wet and shiny after rain, or there are puddles on the road.*
 - *The shade of a guardrail parallel to a white or yellow line is on the road.*
 - *The width of a lane is excessively narrow or wide.*
 - *The road is excessively uneven.*
 - *The vehicle is shaken after hitting a road bump.*
 - *There are two or more adjacent white or yellow lines.*
 - *There are various road markings or lane markings of various shapes near an intersection.*

▼ When the System Operates

1. The system goes on operation standby when the LDWS switch is pressed and the LDWS OFF indicator light in the instrument cluster turns off.

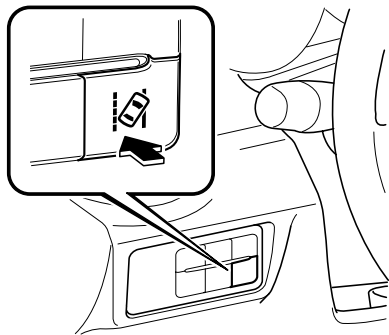

2. Drive the vehicle in the center of the driving lane while the LDWS OFF indicator light is turned off. The system becomes operational when all of the following conditions are met.

- The vehicle is driven in the center of the driving lane with the white or yellow lines on the left and right sides, or on either side.
- The vehicle speed is 65 km/h (41 mph) or faster.
- The vehicle is driven on a straight road or road with gentle curves.

The LDWS does not operate in the following cases:

- The system cannot detect white or yellow lines.
- The vehicle speed is less than 60 km/h (37 mph).
- The vehicle is making a sharp turn.
- The vehicle is making a curve at an inadequate speed.

NOTE

- *The LDWS does not operate until the system detects a white or yellow line on either the left or right.*
- *When the system detects a white or yellow line on one side only, the system will activate the warning only when the vehicle deviates on the side where the white or yellow line is being detected.*
- *The distance and warning sensitivity (likelihood of a warning) which the system uses to determine the possibility of a lane departure can be changed. Refer to Personalization Features on page 9-9.*

Auto cancel

In the following cases, the LDWS cancels automatically and the LDWS warning light in the instrument cluster turns on.

- The temperature inside the camera is high or low.
- The windshield around the camera is foggy.
- The windshield around the camera is blocked by an obstruction, causing poor forward visibility.

The LDWS is enabled automatically when the operation conditions are met, and the LDWS warning light turns off.

Auto cancel warning

When the following operations are performed, the LDWS determines that the driver intends to make a lane change and the LDWS warning is canceled automatically. The LDWS is enabled automatically after the driver performs the operation.

- The steering wheel is operated abruptly.
- The brake pedal is depressed abruptly.
- The accelerator pedal is depressed abruptly.
- The turn signal lever is operated (after the turn signal lever is returned, the LDWS may not operate for about 3 seconds which is the period of time required to make a lane correction).

NOTE

After about 60 seconds have elapsed with the turn signal lever left operating, the LDWS warning may operate if the vehicle is close to a white or yellow line.

▼ Canceling the System

Press the LDWS OFF switch to cancel the LDWS. The LDWS OFF indicator light turns on.

**Vehicle lane display (vehicles with multi-information display)**

The vehicle lane lines are no longer indicated in the multi-information display when the LDWS is canceled.

NOTE

When the ignition is switched OFF, the LDWS becomes operational the next time the ignition is switched ON.

▼ LDWS Warning

If the system determines that there is the possibility of a lane departure, the LDWS warning beep activates and the LDWS warning light flashes. Operate the steering wheel appropriately and steer the vehicle to the center of the lane.

For vehicles equipped with the multi-information display and the active driving display, the color of the lane line in the direction which the system determined that the vehicle may be deviating from its lane changes from white to amber and the vehicle lane line flashes.

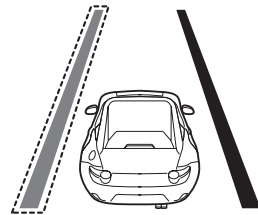
Indication on display

NOTE

- If the LDWS warning sound is set to rumble*1, the sound will be heard from the vehicle speaker on the side which the system determined the vehicle may be deviating from its lane.
- It may be difficult to hear the LDWS warning beep depending on the surrounding conditions such as outside noise.
- The volume of the LDWS warning sound can be changed.
Refer to Personalization Features on page 9-9.
- The type of warning sound (rumble*1/ beep) on the LDWS can be changed.
Refer to Personalization Features on page 9-9.

*1 A rumble strip is a series of grooves in the road pavement surface positioned at specific intervals, and when the vehicle passes over it a vibration and rumble sound is produced which alerts the driver that the vehicle is departing from the lane.

The rumble sound is a reproduction of the sound which occurs when a vehicle passes over a rumble strip.

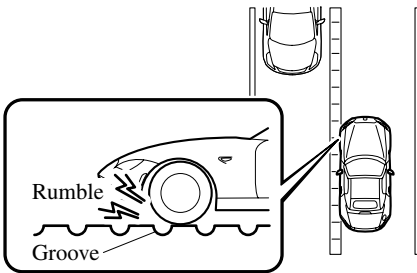

Blind Spot Monitoring (BSM) System*

The Blind Spot Monitoring (BSM) is designed to assist the driver in checking the area to the rear of the vehicle on both sides during lane changes by alerting the driver to the presence of vehicles approaching from the rear in an adjacent lane.

The Blind Spot Monitoring (BSM) detects vehicles approaching from the rear while traveling in the forward direction at a speed of 10 km/h (6.3 mph) or faster and turns on the Blind Spot Monitoring (BSM) warning lights equipped on the door mirrors depending on the conditions. If the turn signal lever is operated to signal a lane change in the direction in which the Blind Spot Monitoring (BSM) warning light is illuminated, the system warns the driver of a vehicle in the detection area by flashing the Blind Spot Monitoring (BSM) warning light and activating a beep sound.

The detection area on this system covers the driving lanes on both sides of the vehicle and from the rear part of the doors to about 50 m (164 ft) behind the vehicle.

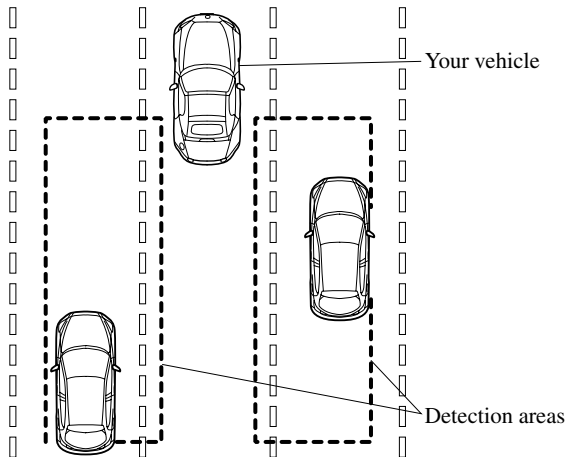

! WARNING

Always check the surrounding area visually before making an actual lane change:

The system is only designed to assist you in checking for vehicles at your rear when making a lane change. Due to certain limitations with the operation of this system, the Blind Spot Monitoring (BSM) warning light may not flash or it might be delayed even though a vehicle is in an adjacent driving lane. Always make it your responsibility as a driver to check the rear.

NOTE

- *The Blind Spot Monitoring (BSM) will operate when all of the following conditions are met:*
 - *The ignition is switched ON.*
 - *The Blind Spot Monitoring (BSM) switch is pressed and the Blind Spot Monitoring (BSM) OFF indicator light in the instrument cluster is turned off.*
 - *The vehicle speed is about 10 km/h (6.3 mph) or faster.*
- *The Blind Spot Monitoring (BSM) will not operate under the following circumstances.*
 - *The vehicle speed falls below about 10 km/h (6.3 mph) even though the Blind Spot Monitoring (BSM) OFF indicator light is turned off.*
 - *The shift lever (manual transmission)/selector lever (automatic transmission) is shifted to reverse (R) and the vehicle is reversing.*
- *In the following cases, the Blind Spot Monitoring (BSM) OFF indicator light turns on and operation of the system is stopped. If the Blind Spot Monitoring (BSM) OFF indicator light remains illuminated, have the vehicle inspected at an Authorized Mazda Dealer as soon as possible.*
 - *Some problem with the system including the Blind Spot Monitoring (BSM) warning lights is detected.*
 - *A large deviation in the installation position of a radar sensor (rear) on the vehicle has occurred.*
 - *There is a large accumulation of snow or ice on the rear bumper near a radar sensor (rear). Remove any snow, ice or mud on the rear bumper.*
 - *Driving on snow-covered roads for long periods.*
 - *The temperature near the radar sensors (rear) becomes extremely hot due to driving for long periods on slopes during the summer.*
 - *The battery voltage has decreased.*
- *Under the following conditions, the radar sensors (rear) cannot detect target objects or it may be difficult to detect them.*
 - *A vehicle is in the detection area at the rear in an adjacent driving lane but it does not approach. The Blind Spot Monitoring (BSM) determines the condition based on radar detection data.*
 - *A vehicle is traveling alongside your vehicle at nearly the same speed for an extended period of time.*
 - *Vehicles approaching in the opposite direction.*
 - *A vehicle in an adjacent driving lane is attempting to pass your vehicle.*
 - *A vehicle is in an adjacent lane on a road with extremely wide driving lanes. The detection area of the radar sensors (rear) is set at the road width of expressways.*

- In the following cases, the activation of the Blind Spot Monitoring (BSM) warning lights and the warning beep may not occur or they may be delayed.
 - A vehicle makes a lane change from a driving lane two lanes over to an adjacent lane.
 - Driving on steep slopes.
 - Crossing the summit of a hill or mountain pass.
 - The turning radius is small (making a sharp turn, turning at intersections).
 - When there is a difference in the height between your driving lane and the adjacent lane.
 - Directly after pressing the Blind Spot Monitoring (BSM) switch and the system becomes operable.
- If the road width is extremely narrow, vehicles two lanes over may be detected. The detection area of the radar sensors (rear) is set according to the road width of expressways.
- The Blind Spot Monitoring (BSM) warning lights may turn on in reaction to stationary objects on the road or the roadside such as guardrails, tunnels, sidewalls, and parked vehicles.

Objects such as guardrails and concrete walls running alongside the vehicle.

Places where the width between guardrails or walls on each side of the vehicle narrows.

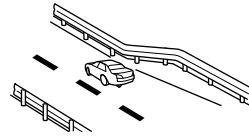
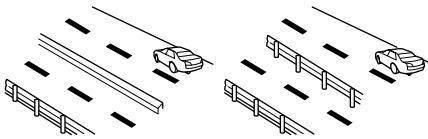

The walls at the entrance and exits of tunnels, turnouts.

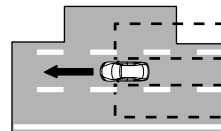
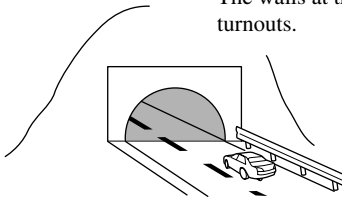

- A Blind Spot Monitoring (BSM) warning light may flash or the warning beep may be activated several times when making a turn at a city intersection.
- Turn off the Blind Spot Monitoring (BSM) while pulling a trailer or while an accessory such as a bicycle carrier is installed to the rear of the vehicle. Otherwise, the radar's radio waves will be blocked causing the system to not operate normally.

- In the following cases, it may be difficult to view the illumination/flashing of the Blind Spot Monitoring (BSM) warning lights equipped on the door mirrors.
 - Snow or ice is adhering to the door mirrors.
 - The door glass is fogged or covered in snow, frost or dirt.
- The system switches to the Rear Cross Traffic Alert function when the shift lever (manual transmission) or the selector lever (automatic transmission) is shifted to the reverse (R) position.
Refer to Rear Cross Traffic Alert (RCTA) on page 4-92.

▼ Blind Spot Monitoring (BSM) Warning Lights/Blind Spot Monitoring (BSM) Warning Beep

The Blind Spot Monitoring (BSM) or Rear Cross Traffic Alert (RCTA) system notifies the driver of the presence of vehicles in adjacent lanes to the rear of your vehicle using the Blind Spot Monitoring (BSM) warning lights and the warning beep while the systems are operational.

Blind Spot Monitoring (BSM) warning lights

The Blind Spot Monitoring (BSM) warning lights are equipped on the left and right door mirrors. The warning lights turn on when a vehicle approaching from the rear in an adjacent lane is detected.

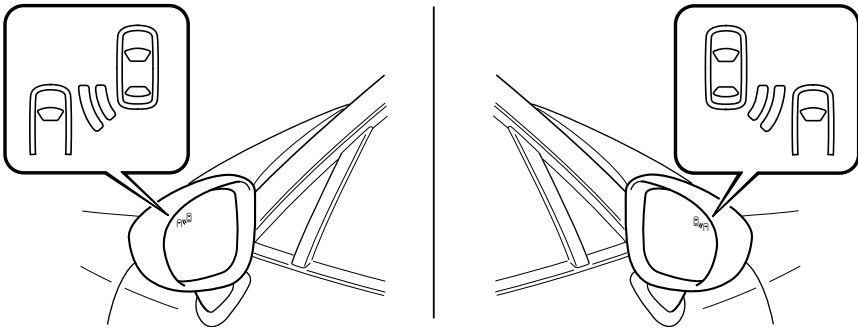

When the ignition is switched ON, the malfunction warning light turns on momentarily and then turns off after a few seconds.

Forward driving (Blind Spot Monitoring (BSM) system operation)

The Blind Spot Monitoring (BSM) system detects vehicles approaching from the rear and turns on the Blind Spot Monitoring (BSM) warning lights equipped on the door mirrors according to the conditions. Additionally, while a Blind Spot Monitoring (BSM) warning light is illuminated, if the turn signal lever is operated to signal a turn in the direction in which the Blind Spot Monitoring (BSM) warning light is illuminated, the Blind Spot Monitoring (BSM) warning light flashes.

Reverse driving (Rear Cross Traffic Alert (RCTA) system operation)

The Rear Cross Traffic Alert (RCTA) system detects vehicles approaching from the left and right of your vehicle and flashes the Blind Spot Monitoring (BSM) warning lights.

Function for cancelling illumination dimmer

If the Blind Spot Monitoring (BSM) warning lights turn on when the parking lights are turned on, the brightness of the Blind Spot Monitoring (BSM) warning lights is dimmed. If the Blind Spot Monitoring (BSM) warning lights are difficult to see due to glare from surrounding brightness when traveling on snow-covered roads or under foggy conditions, press the dimmer cancellation button to cancel the dimmer and increase the brightness of Blind Spot Monitoring (BSM) warning lights when they turn on.

Refer to Dashboard Illumination on page 4-15.

Blind Spot Monitoring (BSM) warning beep

The Blind Spot Monitoring (BSM) warning beep is activated simultaneously with the flashing of a Blind Spot Monitoring (BSM) warning light.

▼ Blind Spot Monitoring (BSM) OFF Indicator Light



- When the ignition is switched ON, the malfunction warning light turns on momentarily and then turns off after a few seconds.
- The Blind Spot Monitoring (BSM) OFF indicator light illuminates when the Blind Spot Monitoring (BSM) switch is pressed to turn off the Blind Spot Monitoring (BSM) and Rear Cross Traffic Alert (RCTA) systems.
- A malfunction in the system may be indicated under the following conditions. Have your vehicle inspected at an Authorized Mazda Dealer.
 - The light does not turn on when the ignition is switched ON.
 - The light remains turned on even if the Blind Spot Monitoring (BSM) switch is operated.
 - It turns on while driving the vehicle.

▼ Blind Spot Monitoring (BSM) Switch

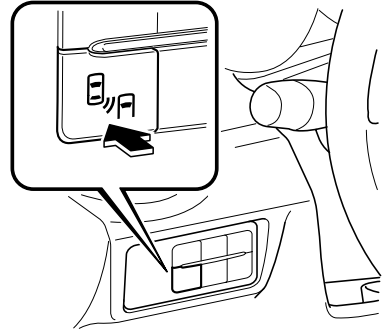

When the Blind Spot Monitoring (BSM) switch is pressed, the Blind Spot Monitoring (BSM) and Rear Cross Traffic Alert (RCTA) systems are turned off and the BSM OFF Indicator Light in the instrument cluster turns on. If the switch is pressed again, the Blind Spot Monitoring (BSM) and Rear Cross Traffic Alert (RCTA) systems become operable and the BSM OFF Indicator Light turns off.

NOTE

- *When the ignition is switched off, the condition before the system was turned off is maintained. For example, if the ignition is switched OFF while the Blind Spot Monitoring (BSM) and Rear Cross Traffic Alert (RCTA) systems are operational, the Blind Spot Monitoring (BSM) and Rear Cross Traffic Alert (RCTA) systems remain operational the next time the ignition is switched ON.*
- *The Blind Spot Monitoring (BSM) and Rear Cross Traffic Alert (RCTA) systems are turned off when the battery is disconnected such as when the battery terminals or fuses have been removed and re-installed. To turn the Blind Spot Monitoring (BSM) and Rear Cross Traffic Alert (RCTA) systems back on, press the Blind Spot Monitoring (BSM) switch.*

Rear Cross Traffic Alert (RCTA)*

The Rear Cross Traffic Alert (RCTA) system is designed to assist the driver in checking the area to the rear of the vehicle on both sides while the vehicle is reversing by alerting the driver to the presence of vehicles approaching the rear of the vehicle.

The Rear Cross Traffic Alert (RCTA) system detects vehicles approaching from the left and right sides of the vehicle while the vehicle is being reversed out of a parking space, and notifies the driver of possible danger using the Blind Spot Monitoring (BSM) warning lights and the warning buzzer.

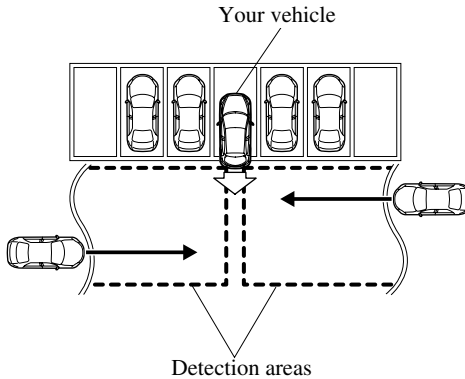

Rear Cross Traffic Alert (RCTA) operation

1. The Rear Cross Traffic Alert (RCTA) system operates when the shift lever (manual transmission) or the selector lever (automatic transmission) is shifted to the reverse (R) position.
2. If there is the possibility of a collision with an approaching vehicle, the Blind Spot Monitoring (BSM) warning light flashes and the warning beep is activated simultaneously.

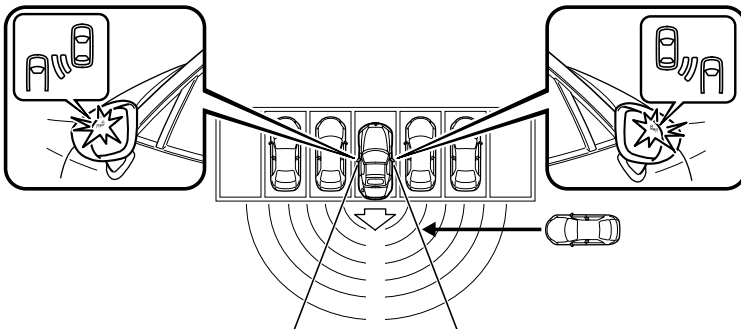

 WARNING

Always check the surrounding area visually before actually putting the vehicle in reverse:

The system is only designed to assist you in checking for vehicles at the rear when putting the vehicle in reverse. Due to certain limitations with the operation of this system, the Blind Spot Monitoring (BSM) warning light may not flash or it might be delayed even though a vehicle is behind your vehicle. Always make it your responsibility as a driver to check the rear.

NOTE

- *In the following cases, the Blind Spot Monitoring (BSM) OFF indicator light turns on and operation of the system is stopped. If the Blind Spot Monitoring (BSM) OFF indicator light remains illuminated, have the vehicle inspected at an Authorized Mazda Dealer as soon as possible.*
 - *Some problem with the system including the Blind Spot Monitoring (BSM) warning lights has occurred.*
 - *A large deviation in the installation position of a radar sensor (rear) on the vehicle has occurred.*
 - *There is a large accumulation of snow or ice on the rear bumper near a radar sensor (rear).*
 - *Driving on snow-covered roads for long periods.*
 - *The temperature near the radar sensors becomes extremely hot due to driving for long periods on slopes during the summer.*
 - *The battery voltage has decreased.*

i-ACTIVSENSE

- Under the following conditions, the radar sensors (rear) cannot detect target objects or it may be difficult to detect them.
 - The vehicle speed when reversing is about 10 km/h (6.3 mph) or faster.
 - The radar sensor (rear) detection area is obstructed by a nearby wall or parked vehicle. (Reverse the vehicle to a position where the radar sensor detection area is no longer obstructed.)

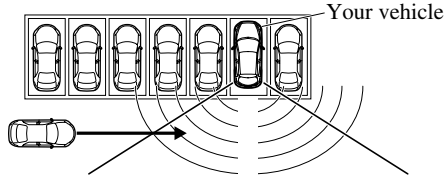

- A vehicle is approaching directly from the rear of your vehicle.

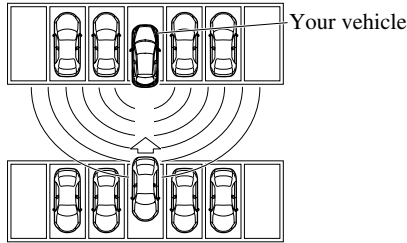

- The vehicle is parked on a slant.

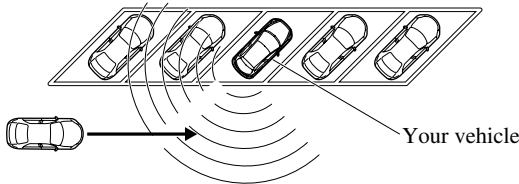

- Directly after pressing the Blind Spot Monitoring (BSM) switch and the system becomes operable.
- In the following cases, it may be difficult to view the illumination/flashing of the Blind Spot Monitoring (BSM) warning lights equipped on the door mirrors.
 - Snow or ice adheres to the door mirrors.
 - The door glass is fogged or covered in snow, frost or dirt.
- Turn off the Rear Cross Traffic Alert (RCTA) system while pulling a trailer or while an accessory such as a bicycle carrier is installed to the rear of the vehicle. Otherwise, the radio waves emitted by the radar will be blocked causing the system to not operate normally.

Forward Sensing Camera (FSC)*

Your vehicle is equipped with a Forward Sensing Camera (FSC). The Forward Sensing Camera (FSC) is positioned near the rearview mirror and used by the following systems.

- High Beam Control System (HBC)
- Lane Departure Warning System (LDWS)

Forward Sensing Camera (FSC)

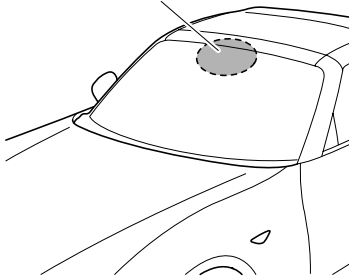

The Forward Sensing Camera (FSC) determines the conditions ahead of the vehicle while traveling at night and detects traffic lanes. The distance in which the Forward Sensing Camera (FSC) can detect objects varies depending on the surrounding conditions.

⚠ CAUTION

- *Do not apply accessories, stickers or film to the windshield near the Forward Sensing Camera (FSC).
If the area in front of the Forward Sensing Camera (FSC) lens is obstructed, it will cause the system to not operate correctly. Consequently, each system may not operate normally which could lead to an unexpected accident.*
- *Do not disassemble or modify the Forward Sensing Camera (FSC).
Disassembly or modification of the Forward Sensing Camera (FSC) will cause a malfunction or mistaken operation. Consequently, each system may not operate normally which could lead to an unexpected accident.*
- *Heed the following cautions to assure the correct operation of the Forward Sensing Camera (FSC).*
 - *The direction of the Forward Sensing Camera (FSC) has been finely adjusted, therefore do not change the installation position or remove the Forward Sensing Camera (FSC).*
 - *Be careful not to scratch the Forward Sensing Camera (FSC) lens or allow it to get dirty.*
 - *Do not remove the Forward Sensing Camera (FSC) cover.*
 - *Do not place objects on the dashboard which reflect light.*
 - *Always keep the windshield glass around the camera clean by removing dirt or fogging. Use the windshield defroster to remove fogging on the windshield.*
 - *Consult an Authorized Mazda Dealer regarding cleaning the interior side of the windshield around the Forward Sensing Camera (FSC).*
 - *Consult an Authorized Mazda Dealer before performing repairs around the Forward Sensing Camera (FSC).*
 - *The Forward Sensing Camera (FSC) is installed to the windshield. Consult an Authorized Mazda Dealer for windshield repair and replacement.*
 - *When performing repairs around the rearview mirror, consult an Authorized Mazda Dealer.*
 - *Do not hit or apply strong force to the Forward Sensing Camera (FSC) or the area around it. If strong force is applied, stop using the Lane Departure Warning System (LDWS), and the High Beam Control System (HBC) and consult an Authorized Mazda Dealer.*
 - *The direction in which the Forward Sensing Camera (FSC) is pointed has been finely adjusted. Do not change the installation position of the Forward Sensing Camera (FSC) or remove it. Otherwise, it could result in damage or malfunction.*

NOTE

- *In the following cases, the Forward Sensing Camera (FSC) cannot detect target objects correctly, and each system may be unable to operate normally.*
 - *The height of the vehicle ahead is low.*
 - *You drive your vehicle at the same speed as the vehicle ahead.*
 - *Headlights are not turned on during the night or when going through a tunnel.*
- *In the following cases, the Forward Sensing Camera (FSC) may not be able to detect target objects correctly.*
 - *When driving next to walls with no patterning (including fences and longitudinally striped walls).*
 - *The taillights of the vehicle ahead are turned off.*
 - *A vehicle is outside the illumination range of the headlights.*
 - *The vehicle is making a sharp turn, or ascending or descending a steep slope.*
 - *Entering or exiting a tunnel.*
 - *Heavy luggage is loaded causing the vehicle to tilt.*
 - *Strong light is shone at the front of the vehicle (back light or high-beam light from oncoming vehicles).*
 - *There are many light emitters on the vehicle ahead.*
 - *When the vehicle ahead is not equipped with taillights or the taillights are turned off at nighttime.*
 - *The vehicle ahead has a special shape. For example, a vehicle towing a trailer house or a boat, or a vehicle carrier carrying a vehicle with its front pointed rearward.*

Radars Sensors (Rear)*

Your vehicle is equipped with radar sensors (rear). The following systems also use the radar sensors (rear).

- Blind Spot Monitoring system (BSM)
- Rear Cross Traffic Alert (RCTA)

The radar sensors (rear) function by detecting the radio waves reflected off a vehicle approaching from the rear or an obstruction sent from the radar sensor.

Radars sensors (rear)

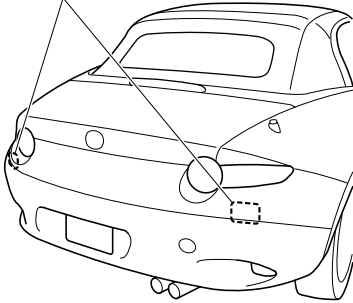

The radar sensors (rear) are installed inside the rear bumper, one each on the left and right sides.

Always keep the surface of the rear bumper near the radar sensors (rear) clean so that the radar sensors (rear) operate normally. Also, do not apply items such as stickers.

Refer to Exterior Care on page 6-59.

CAUTION

If the rear bumper receives a severe impact, the system may no longer operate normally. Stop the system immediately and have the vehicle inspected at an Authorized Mazda Dealer.

NOTE

- *The detection ability of the radar sensors (rear) has limitations. In the following cases, the detection ability may be lower and the system may not operate normally.*
 - *The rear bumper near the radar sensors (rear) has become deformed.*
 - *Snow, ice or mud adheres to the radar sensors (rear) on the rear bumper.*
 - *Under bad weather conditions such as rain, snow and fog.*
- *Under the following conditions, the radar sensors (rear) cannot detect target objects or it may be difficult to detect them.*
 - *Stationary objects on a road or a road side such as small, two-wheeled vehicles, bicycles, pedestrians, animals, and shopping carts.*
 - *Vehicle shapes which do not reflect radar waves well such as empty trailers with a low vehicle height and sports cars.*
- *Vehicles are shipped with the direction of the radar sensors (rear) adjusted for each vehicle to a loaded vehicle condition so that the radar sensors (rear) detect approaching vehicles correctly. If the direction of the radar sensors (rear) has deviated for some reason, have the vehicle inspected at an Authorized Mazda Dealer.*
- *For repairs or replacement of the radar sensors (rear), or bumper repairs, paintwork, and replacement near the radar sensors, consult an Authorized Mazda Dealer.*
- *Turn off the system while pulling a trailer or while an accessory such as a bicycle carrier is installed to the rear of the vehicle. Otherwise, the radio waves emitted by the radar will be blocked causing the system to not operate normally.*
- *The radar sensors are regulated by the relevant radio wave laws of the country in which the vehicle is driven. If the vehicle is driven abroad, authorization from the country in which the vehicle is driven may be required.*

Cruise Control

Cruise Control*

With cruise control, you can set and automatically maintain any speed of more than about 25 km/h (16 mph).

⚠ WARNING

Do not use the cruise control under the following conditions:

Using the cruise control under the following conditions is dangerous and could result in loss of vehicle control.

- > Hilly terrain
- > Steep inclines
- > Heavy or unsteady traffic
- > Slippery or winding roads
- > Similar restrictions that require inconsistent speed

▼ Cruise Control Switch

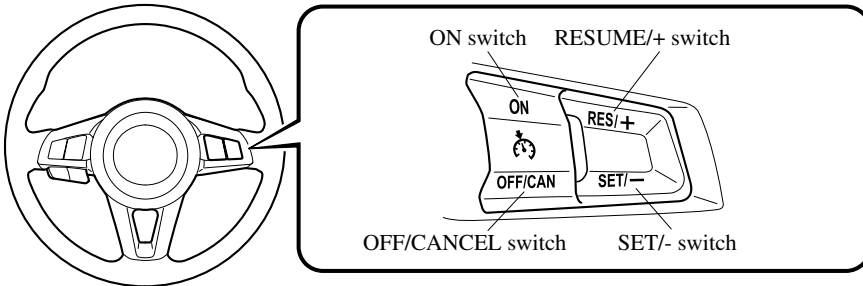

▼ **Cruise Main Indication (White)/
Cruise Set Indication (Green),
Cruise Main Indicator Light
(Amber)/Cruise Set Indicator
Light (Green)**



Type A instrument cluster

(Cruise main indication (white))

The indication turns on (white) when the cruise control system is activated.

(Cruise set indication (green))

The indication turns on (green) when a cruising speed has been set.

Type B instrument cluster

(Cruise main indicator light (amber))

The indicator light turns on (amber) when the cruise control system is activated.

(Cruise set indicator light (green))

The indicator light turns on (green) when a cruising speed has been set.

▼ **Activation/Deactivation**

To activate the system, press the ON switch. The cruise main indicator light (amber)/cruise main indication (white) turns on.

To deactivate the system, press the OFF/CANCEL switch.

The cruise main indicator light (amber)/cruise main indication (white) turns off.

⚠ WARNING

Always turn off the cruise control system when it is not in use:

Leaving the cruise control system in an activation-ready state while the cruise control is not in use is dangerous as the cruise control could unexpectedly activate if the activation button is accidentally pressed, and result in loss of vehicle control and an accident.

NOTE

When the ignition is switched OFF, the system status before it was turned off is maintained. For example, if the ignition is switched OFF with the cruise control system operable, the system will be operable when the ignition is switched ON the next time.

▼ **To Set Speed**

1. Activate the cruise control system by pressing the ON switch. The cruise main indicator light (amber)/cruise main indication (white) turns on.
2. Accelerate to the desired speed, which must be more than 25 km/h (16 mph).
3. Set the cruise control by pressing the SET/— switch at the desired speed. The cruise control is set at the moment the SET/— switch is pressed. Release the accelerator pedal simultaneously. The cruise set indicator light/cruise set indication (green) turns on.

Cruise Control

NOTE

- *The cruise control speed setting cannot be performed under the following conditions:*
 - **(Automatic transmission)**
The selector lever is in the P or N position.
 - **(Manual transmission)**
The shift lever is in the neutral position.
 - *The parking brake is applied.*
- *Release the SET/− or RESUME/+ switch at the desired speed, otherwise the speed will continue increasing while the RESUME/+ switch is pressed and held, and continue decreasing while the SET/− switch is pressed and held (except when the accelerator pedal is depressed).*
- *On a steep grade, the vehicle may momentarily slow down while ascending or speed up while descending.*
- *The cruise control will cancel if the vehicle speed decreases below 21 km/h (13 mph) when the cruise control is activated, such as when climbing a steep grade.*
- *The cruise control may cancel at about 15 km/h (9 mph) below the preset speed, such as when climbing a long, steep grade.*

The vehicle speed preset using the cruise control is displayed in the instrument cluster.

Type A Instrument Cluster

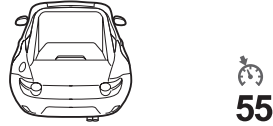

Type B Instrument Cluster



▼ To Increase Cruising Speed

Follow either of these procedures.

To increase speed using cruise control switch

Press the RESUME/+ switch and hold it. Your vehicle will accelerate. Release the switch at the desired speed.

Press the RESUME/+ switch and release it immediately to adjust the preset speed. Multiple operations will increase the preset speed according to the number of times it is operated.

Increasing speed with a single RESUME/+ switch operation

Instrument cluster display for vehicle speed indicated in km/h: 1 km/h (0.6 mph)
Instrument cluster display for vehicle speed indicated in mph: 1 mph (1.6 km/h)

To increase speed using accelerator pedal

Depress the accelerator pedal to accelerate to the desired speed. Press the SET/– switch and release it immediately.

NOTE

Accelerate if you want to speed up temporarily when the cruise control is on. Greater speed will not interfere with or change the set speed. Take your foot off the accelerator to return to the set speed.

▼ To Decrease Cruising Speed

Press the SET/– switch and hold it. The vehicle will gradually slow. Release the switch at the desired speed.

Press the SET/– switch and release it immediately to adjust the preset speed. Multiple operations will decrease the preset speed according to the number of times it is operated.

Decreasing speed with a single SET/– switch operation

Instrument cluster display for vehicle speed indicated in km/h: 1 km/h (0.6 mph)
Instrument cluster display for vehicle speed indicated in mph: 1 mph (1.6 km/h)

▼ To Resume Cruising Speed at More Than 25 km/h (16 mph)

If some other method besides the OFF/CANCEL switch was used to cancel cruising speed (such as applying the brake pedal) and the system is still activated, the most recent set speed will automatically resume when the RESUME/+ switch is pressed.

If vehicle speed is below 25 km/h (16 mph), increase the vehicle speed up to 25 km/h (16 mph) or more and press the RESUME/+ switch.

▼ To Temporarily Cancel

To temporarily cancel the system, use one of these methods:

- Slightly depress the brake pedal.
- **(Manual transmission)**
Depress the clutch pedal.
- Press the OFF/CANCEL switch.

Cruise Control

If the RESUME/+ switch is pressed when the vehicle speed is 25 km/h (16 mph) or higher, the system reverts to the previously set speed.

NOTE

- *If any of the following conditions occur, the cruise control system is temporarily canceled.*
 - *The parking brake is applied.*
 - **(Automatic transmission)**
The selector lever is in the P or N position.
 - **(Manual transmission)**
The shift lever is in the neutral position.
- *When the cruise control system is temporarily canceled by even one of the applicable cancel conditions, the speed cannot be re-set.*
- **(Automatic transmission)**
The cruise control cannot be cancelled while driving in manual mode (selector lever shifted from D to M position). Therefore, engine braking will not be applied even if the transmission is shifted down to a lower gear. If deceleration is required, lower the set speed or depress the brake pedal.

▼ To Deactivate

When a cruising speed has been set (cruise set indicator light/cruise set indication(green) turns on)

Long-press the OFF/CANCEL switch or press the OFF/CANCEL switch 2 times.

When a cruising speed has not been set (cruise main indicator light (amber)/cruise main indication (white)turns on)

Press the OFF/CANCEL switch.

Tire Pressure Monitoring System*

The Tire Pressure Monitoring System (TPMS) monitors the air pressure of all four tires. If the air pressure of one or more tires is too low, the system warns the driver by indicating the tire pressure monitoring system warning light in the instrument cluster and operating a beep sound. The system monitors the tire pressures indirectly using the data sent from the ABS wheel speed sensors.

To allow the system to operate correctly, the system needs to be initialized with the specified tire pressure (value on the tire pressure label). Follow the procedure and perform the initialization.

Refer to Tire Pressure Monitoring System Initialization on page 4-108.

The warning light flashes when the system has a malfunction.

Refer to Warning Indication/Warning Lights on page 4-26.

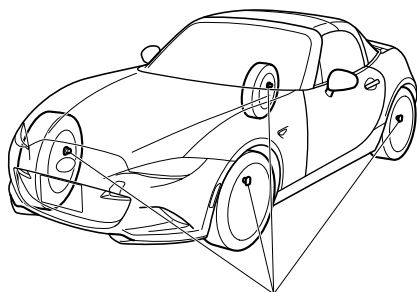

ABS wheel speed sensor

Tire Pressure Monitoring System

CAUTION

- *Each tire, including the spare (if provided), should be checked monthly when cold and inflated to the inflation pressure recommended by the vehicle manufacturer on the vehicle placard or tire inflation pressure label. (If your vehicle has tires of a different size than the size indicated on the vehicle placard or tire inflation pressure label, you should determine the proper tire inflation pressure for those tires.)*

As an added safety feature, your vehicle has been equipped with a tire pressure monitoring system (TPMS) that illuminates a low tire pressure telltale when one or more of your tires is significantly under-inflated. Accordingly, when the low tire pressure telltale illuminates, you should stop and check your tires as soon as possible, and inflate them to the proper pressure. Driving on a significantly under-inflated tire causes the tire to overheat and can lead to tire failure. Under-inflation also reduces fuel efficiency and tire tread life, and may affect the vehicle's handling and stopping ability.

Please note that the TPMS is not a substitute for proper tire maintenance, and it is the driver's responsibility to maintain correct tire pressure, even if under-inflation has not reached the level to trigger illumination of the TPMS low tire pressure telltale.

Your vehicle has also been equipped with a TPMS malfunction indicator to indicate when the system is not operating properly.

The TPMS malfunction indicator is combined with the low tire pressure telltale. When the system detects a malfunction, the telltale will flash for approximately one minute and then remain continuously illuminated. This sequence will continue upon subsequent vehicle start-ups as long as the malfunction exists. When the malfunction indicator is illuminated, the system may not be able to detect or signal low tire pressure as intended. TPMS malfunctions may occur for a variety of reasons, including the installation of replacement or alternate tires or wheels on the vehicle that prevent the TPMS from functioning properly. Always check the TPMS malfunction telltale after replacing one or more tires or wheels on your vehicle to ensure that the replacement or alternate tires and wheels allow the TPMS to continue to function properly.
- *To avoid false readings, the system samples for a little while before indicating a problem. As a result it will not instantaneously register a rapid tire deflation or blow out.*

Tire Pressure Monitoring System

NOTE

Because this system detects slight changes in tire conditions, the timing of the warning may be faster or slower in the following cases:

- *The size, manufacturer, or the type of tires is different from the specification.*
- *The size, manufacturer, or the type of a tire is different from the others, or the level of tire wear is excessively different between them.*
- *A run-flat tire, studless tire, snow tire, or tire chains are used.*
- *An emergency tire is used (The tire pressure monitoring system warning light may flash and then continue illuminating).*
- *A tire is repaired using the emergency flat tire repair kit.*
- *The tire pressure is excessively higher than the specified pressure, or the tire pressure is suddenly lowered for some reason such as a tire burst during driving.*
- *The vehicle speed is lower than about 15 km/h (9.3 mph) (including when the vehicle is stopped), or the drive period is shorter than 5 minutes.*
- *The vehicle is driven on an extremely rough road or a slippery, icy road.*
- *Hard steering and rapid acceleration/deceleration are repeated such as during aggressive driving on a winding road.*
- *Load on the vehicle is applied to a tire such as by loading heavy luggage to one side of the vehicle.*
- *System initialization has not been implemented with the specified tire pressure.*

Tire Pressure Monitoring System

▼ Tire Pressure Monitoring System Initialization

In the following cases, system initialization must be performed so that the system operates normally.

- A tire pressure is adjusted.
- Tire rotation is performed.
- A tire or wheel is replaced.
- The battery is replaced or completely drained.
- The tire pressure monitoring system warning light is illuminated.

Initialization method

1. Park the car in a safe place and firmly apply the parking brake.
2. Let the tires cool, then adjust the tire pressure of all four (4) tires to the specified pressure indicated on the tire pressure label located on the driver's door frame (door open).
Refer to Tires on page 9-8.
3. Switch the ignition ON.
4. Press and hold the tire pressure monitoring system set switch and verify that the tire pressure monitoring system warning light in the instrument cluster flashes twice and a beep sound is heard once.

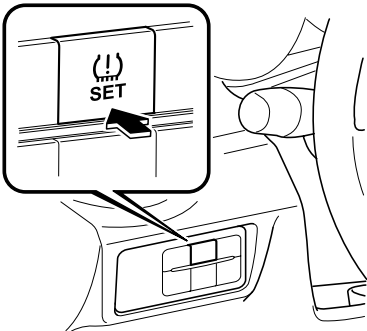

⚠ CAUTION

If the system initialization is performed without adjusting the tire pressure, the system cannot detect the normal tire pressure and it may not illuminate the tire pressure monitoring system warning light even if a tire pressure is low, or it may illuminate the light even if the pressures are normal.

Adjust the tire pressure on all four tires and initialize the system when the warning light is turned on. If the warning light turns on for a reason other than a flat tire, the tire pressure of all four tires may have decreased naturally.

The system initialization will not be performed if the switch is pressed while the vehicle is being driven.

Use of various features for ride comfort, including air-conditioning and audio system.

Climate Control System	5-2
Operating Tips.....	5-2
Vent Operation.....	5-3
Manual Type.....	5-5
Fully Automatic Type.....	5-9
Audio System	5-13
Antenna.....	5-13
Operating Tips for Audio System.....	5-14
Audio set [Type A (non-touchscreen)].....	5-22
Audio set [Type B (touchscreen)].....	5-34
Audio Control Switch Operation.....	5-55
AUX/USB mode.....	5-57
Bluetooth®	5-74
Bluetooth®.....	5-74
Bluetooth® Hands-Free (Type A).....	5-97
Bluetooth® Hands-Free (Type B).....	5-103
Bluetooth® Audio (Type A).....	5-113
Bluetooth® Audio (Type B).....	5-115
Troubleshooting.....	5-129
Interior Equipment	5-132
Sunvisors.....	5-132
Interior Lights.....	5-132
Accessory Sockets.....	5-134
Cup Holder.....	5-135
Storage Compartments.....	5-138
Windblocker.....	5-140

Climate Control System

Operating Tips

- Operate the climate control system with the engine running.
- To prevent the battery from being discharged, do not leave the fan control dial on for a long period of time with the ignition switched ON when the engine is not running.
- Clear all obstructions such as leaves, snow and ice from the hood and the air inlet in the cowl grille to improve the system efficiency.
- Use the climate control system to defog the windows and dehumidify the air.
- The recirculate mode should be used when driving through tunnels or while in a traffic jam, or when you would like to shut off outside air for quick cooling of the interior.
- Use the outside air position for ventilation or windshield defrosting.
- If the vehicle has been parked in direct sunlight during hot weather, open the windows to let warm air escape, then run the climate control system.
- Run the air conditioner about 10 minutes at least once a month to keep internal parts lubricated.

- Have the air conditioner checked before the weather gets hot. Lack of refrigerant may make the air conditioner less efficient.

The refrigerant specifications are indicated on a label attached to the inside of the engine compartment. Check the label before refilling the refrigerant. If the wrong type of refrigerant is used, it could result in a serious malfunction of the air conditioner.

For details, consult an Authorized Mazda Dealer.

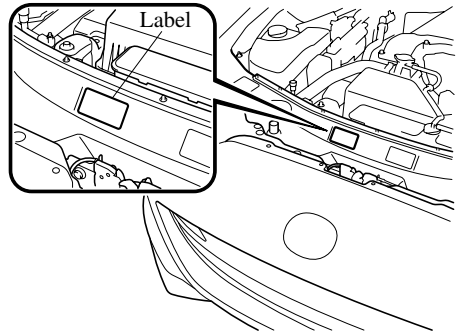

Vent Operation

▼ Adjusting the Vents

Directing airflow

To adjust the direction of airflow, move the adjustment knob.

NOTE

When using the air conditioner under humid ambient temperature conditions, the system may blow fog from the vents. This is not a sign of trouble but a result of humid air being suddenly cooled.

Center vents (driver) and Side vents

Air vent open/close

NOTE

The air vents can be fully opened and closed by operating the knob.

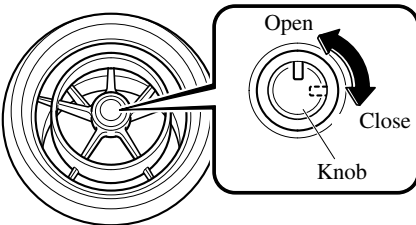

Airflow direction adjustment

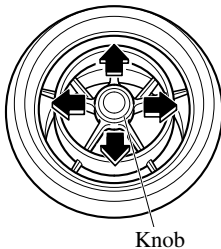

Center vents (passenger)

Air vent open/close

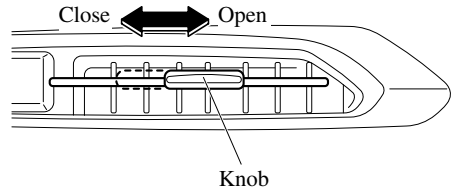

Airflow direction adjustment

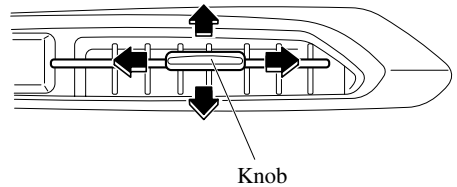

Climate Control System

▼ Selecting the Airflow Mode

Dashboard Vents

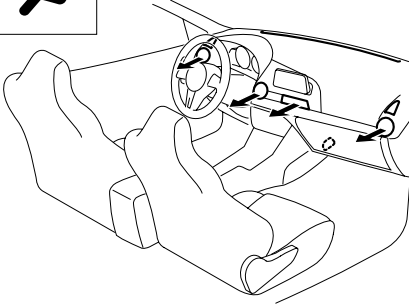

Defroster and Floor Vents

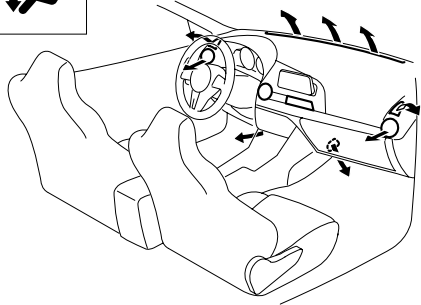

Dashboard and Floor Vents

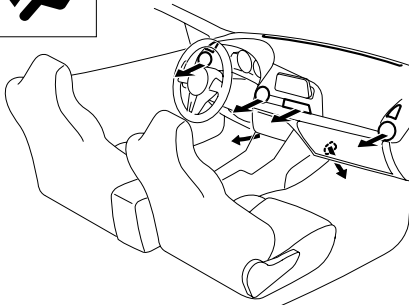

Defroster Vents

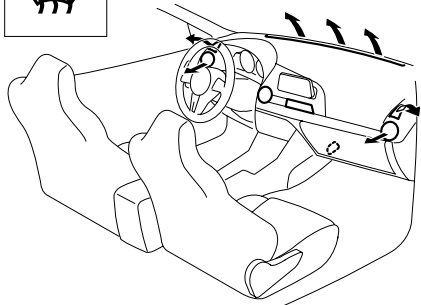
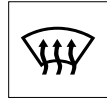

Floor Vents

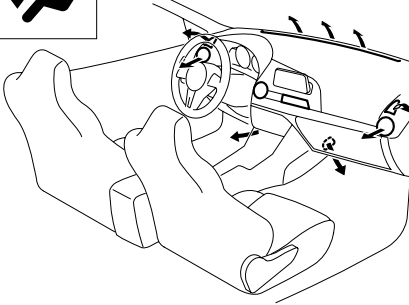

Manual Type

Type A

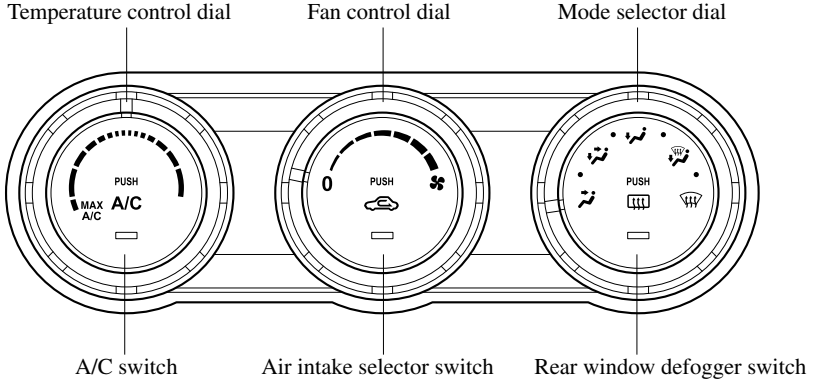

Type B

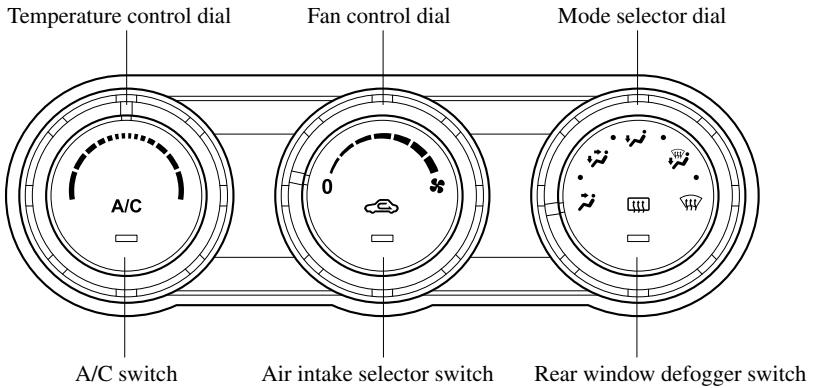

Climate Control System



▼ Control Switches

Temperature control dial

This dial controls temperature. Turn it clockwise for hot and counterclockwise for cold.

NOTE

(Type A)

When the mode is set to ,  or a position in between them with the fan control dial in a position other than 0 and the temperature control dial in the maximum cold position, the air intake selector switches to the recirculated air position and the A/C turns on automatically. If A/C is not desired, press the A/C switch to turn it off.



Fan control dial

This dial allows variable fan speeds. The fan has seven speeds.

Mode selector dial

Turn the mode selector dial to select airflow mode (page 5-4).

NOTE

- The mode selector dial can be set at the intermediate positions (●) between each mode. Set the dial to an intermediate position if you want to split the airflow between the two modes.
- For example, when the mode selector dial is at the ● position between the  and  positions, airflow from the floor vent is less than that of the  position.

A/C switch

Press the A/C switch to turn the air conditioner on. The indicator light on the switch will illuminate when the fan control dial is in any position except OFF.

Press the switch once again to turn the air conditioner off.

NOTE

The air conditioner may not function when the outside temperature approaches 0 °C (32 °F).

Air intake selector

This switch controls the source of air entering the vehicle.

Outside or recirculated air positions can be selected. Press the switch to select outside/recirculated air positions.

Recirculated air position (indicator light illuminated)

Outside air is shut off. Use this position when going through tunnels, driving in congested traffic (high engine exhaust areas) or when quick cooling is desired.

Outside air position (indicator light turned off)

Outside air is allowed to enter the cabin. Use this mode for ventilation or windshield defrosting.



Do not use the position in cold or rainy weather:

Using the  position in cold or rainy weather is dangerous as it will cause the windows to fog up. Your vision will be hampered, which could lead to a serious accident.

Rear window defogger switch



Press the rear window defogger switch to defrost the rear window.

Refer to Rear Window Defogger on page 4-55.

▼ Heating

1. Set the mode selector dial to the  position.
2. Set the air intake selector to the outside air position (indicator light turns off).
3. Set the temperature control dial to the hot position.
4. Set the fan control dial to the desired speed.
5. If dehumidified heating is desired, turn on the air conditioner.

NOTE

- If the windshield fogs up easily, set the mode selector dial to the  position.
- If cooler air is desired at face level, set the mode selector dial at the  position and adjust the temperature control dial to maintain maximum comfort.
- The air to the floor is warmer than air to the face (except when the temperature control dial is set at the extreme hot or cold position).

▼ Cooling (With air conditioner)

1. Set the mode selector dial to the  position.
2. Set the temperature control dial to the cold position.
3. Set the fan control dial to the desired speed.
4. Turn on the air conditioner by pressing the A/C switch.
5. After cooling begins, adjust the fan control dial and temperature control dial as needed to maintain maximum comfort.

⚠ CAUTION

If the air conditioner is used while driving up long hills or in heavy traffic, monitor the engine coolant temperature warning light to see if it is illuminated or flashing (page 4-18). The air conditioner may cause engine overheating. If the warning light is illuminated or flashing, turn the air-conditioning off (page 7-27).

NOTE

- When maximum cooling is desired, set the temperature control dial to the extreme cold position and set the air intake selector to the recirculated air position, then turn the fan control dial fully clockwise.
- If warmer air is desired at floor level, set the mode selector dial at the  position and adjust the temperature control dial to maintain maximum comfort.
- The air to the floor is warmer than air to the face (except when the temperature control dial is set at the extreme hot or cold position).

▼ Ventilation

1. Set the mode selector dial to the  position.
2. Set the air intake selector to the outside air position (indicator light turns off).
3. Set the temperature control dial to the desired position.
4. Set the fan control dial to the desired speed.



Climate Control System

▼ Windshield Defrosting and Defogging





1. Set the mode selector dial to the  position.
2. Set the temperature control dial to the desired position.
3. Set the fan control dial to the desired speed.
4. If dehumidified heating is desired, turn on the air conditioner.

WARNING

Do not defog the windshield using the  position with the temperature control set to the cold position:

Using the  position with the temperature control set to the cold position is dangerous as it will cause the outside of the windshield to fog up. Your vision will be hampered, which could lead to a serious accident. Set the temperature control to the hot or warm position when using the  position.

NOTE

- For maximum defrosting, turn on the air conditioner, set the temperature control dial to the extreme hot position, and turn the fan control dial fully clockwise.
- If warm air is desired at the floor, set the mode selector dial to the  position.
- When the fan control dial is ON, and the mode selector dial is in the  or  position, the air conditioner is automatically turned on and the outside air position is automatically selected to defrost the windshield. In the  or  position, the outside air position cannot be changed to the recirculated air position.

▼ Dehumidifying (With air conditioner)

Operate the air conditioner in cool or cold weather to help defog the windshield and side windows.

1. Set the mode selector dial to the desired position.
2. Set the air intake selector to the outside air position (indicator light turns off).
3. Set the temperature control dial to the desired position.
4. Set the fan control dial to the desired speed.
5. Turn on the air conditioner by pressing the A/C switch.

NOTE

One of the functions of the air conditioner is dehumidifying the air and, to use this function, the temperature does not have to be set to cold. Therefore, set the temperature control dial to the desired position (hot or cold) and turn on the air conditioner when you want to dehumidify the cabin air.

Fully Automatic Type

Type A

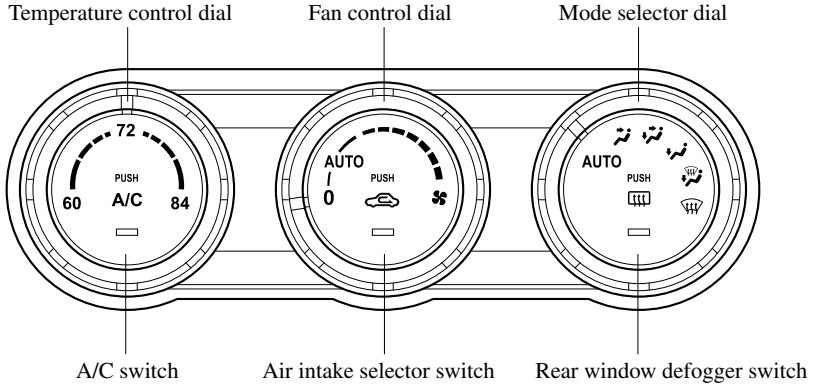

Type B

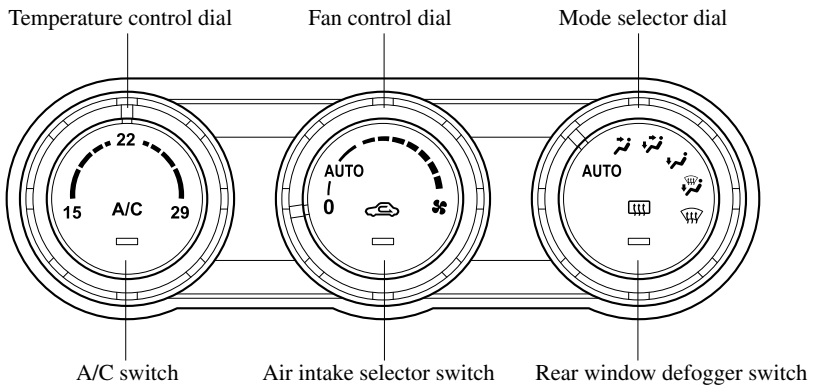

Climate Control System

▼ Control Switches

Temperature control dial

This dial controls temperature. Turn it clockwise for hot and counterclockwise for cold.

Fan control dial

The fan has seven speeds.

AUTO position

The amount of airflow will be automatically controlled in accordance with the set temperature.

Except AUTO position

The airflow amount can be adjusted to the desired level by turning the dial.

0 position

To turn off the system, set the dial to 0 position.

Mode selector dial

Turn the mode selector dial to select airflow mode (page 5-4).





AUTO position

The airflow mode automatically adjusts to the selected temperature.

Except AUTO position

The desired airflow position can be selected by turning the dial.

NOTE

- With the airflow mode set to the  position and the temperature control dial set at a medium temperature, heated air is directed to the feet and air at a comparably lower temperature will flow through the central, left and right vents.
- When the fan control dial is ON, and the mode selector dial is in the  or  position, the air conditioner is automatically turned on and the outside air position is automatically selected to defrost the windshield. In the  or  position, the outside air position cannot be changed to the recirculated air position.

A/C switch

The air-conditioning (cooling/dehumidifying functions) can be turned on or off by pressing the switch while the fan control dial is at a position other than 0.

The indicator light turns on while the air-conditioning is operating.

NOTE

The air conditioner may not function when the outside temperature approaches 0 °C (32 °F).

Air intake selector

Outside or recirculated air positions can be selected. Press the switch to select outside/recirculated air positions.

Recirculated air position (indicator light illuminated)

Outside air is shut off. Use this position when going through tunnels, driving in congested traffic (high engine exhaust areas) or when quick cooling is desired.

Outside air position (indicator light turned off)

Outside air is allowed to enter the cabin. Use this mode for ventilation or windshield defrosting.



Do not use the position in cold or rainy weather:

Using the  position in cold or rainy weather is dangerous as it will cause the windows to fog up. Your vision will be hampered, which could lead to a serious accident.

Rear window defogger switch

Press the rear window defogger switch to defrost the rear window.

Refer to Rear Window Defogger on page 4-55.

▼ Operation of Automatic Air-Conditioning

1. Set the mode selector dial to the AUTO position.
2. Set the air intake selector to the outside air position (indicator light turned off).

NOTE

If the recirculated air position is used for long periods in cold weather or high humidity, the windshield may fog up more easily.

3. Set the fan control dial to the AUTO position.
4. Press the A/C switch to operate the air-conditioning (turn indicator light on).
5. Set the temperature control dial to the desired position.
6. To turn off the system, set the fan control dial to the 0 position.

NOTE

- Setting the temperature to maximum hot or cold will not provide the desired temperature at a faster rate.
- When selecting heat, the system will restrict airflow until it has warmed to prevent cold air from blowing out of the vents.

▼ Windshield Defrosting and Defogging

Set the mode selector dial to the  position and turn the fan control dial to the desired speed.

In this position, the outside air position is automatically selected, and when the fan control dial is ON, the air conditioner automatically turns on. The air conditioner will directly dehumidify the air to the front windshield and side windows (page 5-4). Airflow amount will be increased.



Set the temperature control to the hot or warm position when defogging (position):

Using the  position with the temperature control set to the cold position is dangerous as it will cause the outside of the windshield to fog up. Your vision will be hampered, which could lead to a serious accident.

NOTE

Use the temperature control dial to increase the air flow temperature and defog the windshield more quickly.

Climate Control System

▼ Sunlight/Temperature Sensor

Sunlight sensor

Do not place objects on the sunlight sensor. Otherwise, the interior temperature may not adjust correctly.

Sunlight sensor

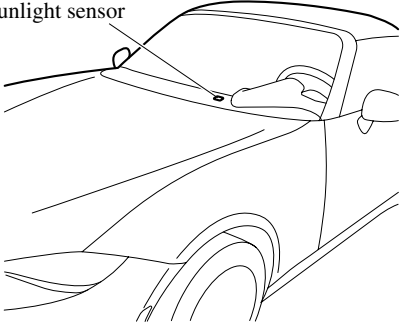

Interior temperature sensor

Do not cover the interior temperature sensor. Otherwise, the interior temperature may not adjust correctly.

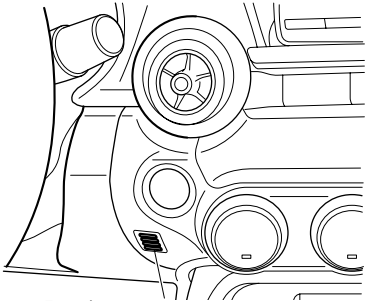

Interior temperature sensor

Antenna

AM/FM Radio Antenna

The AM/FM radio antenna receives both AM and FM signals.

To remove the antenna, turn it counterclockwise.

To install the antenna, turn it clockwise. Make sure the antenna is securely installed.

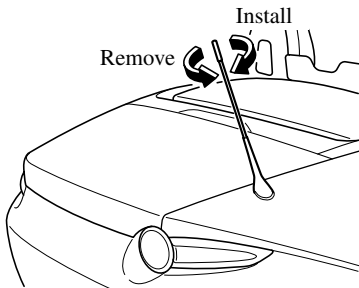

CAUTION

To prevent damage to the antenna, remove it before passing beneath a low overhead clearance.

NOTE

When leaving your vehicle unattended, we recommend that you remove the antenna and store it inside the vehicle.

Satellite Radio Antenna*

The satellite radio antenna receives SiriusXM signals.

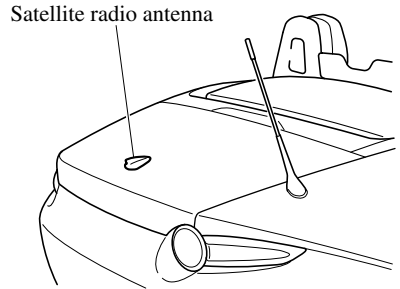

Audio System

Operating Tips for Audio System

! WARNING

Always adjust the audio while the vehicle is stopped:

Do not adjust the audio control switches while driving the vehicle. Adjusting the audio while driving the vehicle is dangerous as it could distract your attention from the vehicle operation which could lead to a serious accident.

Even if the audio control switches are equipped on the steering wheel, learn to use the switches without looking down at them so that you can keep your maximum attention on the road while driving the vehicle.

! CAUTION

For the purposes of safe driving, adjust the audio volume to a level that allows you to hear sounds outside of the vehicle including car horns and particularly emergency vehicle sirens.

NOTE

- *To prevent the battery from being discharged, do not leave the audio system on for a long period of time when the engine is not running.*
- *If a cellular phone or CB radio is used in or near the vehicle, it could cause noise to occur from the audio system, however, this does not indicate that the system has been damaged.*

Do not spill any liquid on the audio system.

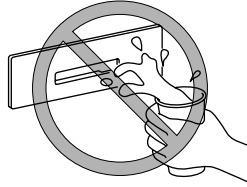

Do not insert any objects, other than CDs, into the slot.

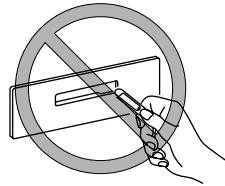

▼ Radio Reception

AM characteristics

AM signals bend around such things as buildings or mountains and bounce off the ionosphere.

Therefore, they can reach longer distances than FM signals.

Because of this, two stations may sometimes be picked up on the same frequency at the same time.

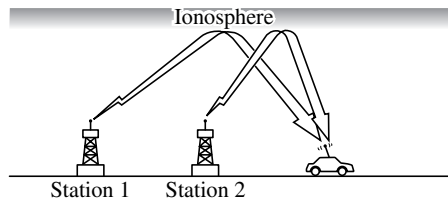

FM characteristics

An FM broadcast range is usually about 40—50 km (25—30 miles) from the source. Because of extra coding needed to break the sound into two channels, stereo FM has even less range than monaural (non-stereo) FM.

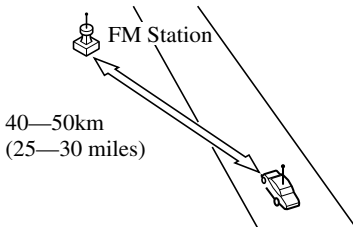

Signals from an FM transmitter are similar to beams of light because they do not bend around corners, but they do reflect. Unlike AM signals, FM signals cannot travel beyond the horizon. Therefore, FM stations cannot be received at the great distances possible with AM reception.

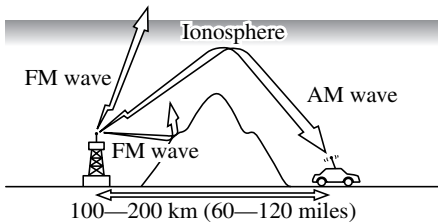

Atmospheric conditions can also affect FM reception. High humidity will cause poor reception. However, cloudy days may provide better reception than clear days.

Multipath noise

Since FM signals can be reflected by obstructions, it is possible to receive both the direct signal and the reflected signal at the same time. This causes a slight delay in reception and may be heard as a broken sound or a distortion. This problem may also be encountered when in close proximity to the transmitter.

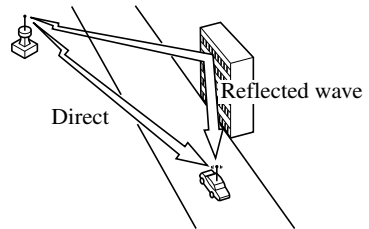

Flutter/Skip noise

Signals from an FM transmitter move in straight lines and become weak in valleys between tall buildings, mountains, and other obstacles. When a vehicle passes through such an area, the reception conditions may change suddenly, resulting in annoying noise.

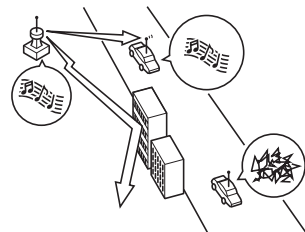

Audio System

Weak signal noise

In suburban areas, broadcast signals become weak because of distance from the transmitter. Reception in such fringe areas is characterized by sound breakup.

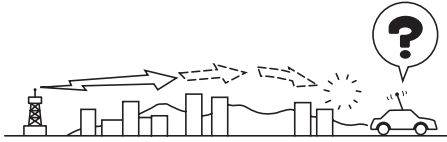

Strong signal noise

This occurs very close to a transmitter tower. The broadcast signals are extremely strong, so the result is noise and sound breakup at the radio receiver.

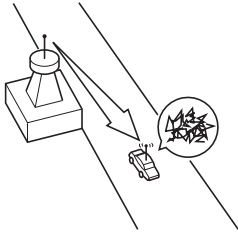

Station drift noise

When a vehicle reaches the area of two strong stations broadcasting at similar frequencies, the original station may be temporarily lost and the second station picked up. At this time there will be some noise from this disturbance.

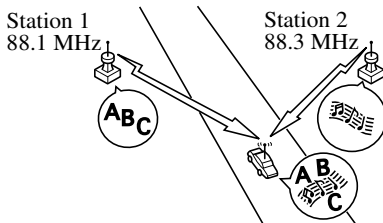

▼ Operating Tips for CD Player

Condensation phenomenon

Immediately after turning on the heater when the vehicle is cold, the CD or optical components (prism and lens) in the CD player may become clouded with condensation. At this time, the CD will eject immediately when placed in the unit. A clouded CD can be corrected simply by wiping it with a soft cloth. Clouded optical components will clear naturally in about an hour. Wait for normal operation to return before attempting to use the unit.

Handling the CD player

The following precautions should be observed.

- Do not use deformed or cracked CDs. The disc may not eject resulting in a malfunction.

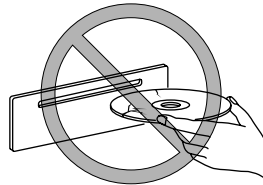

- Do not use non-conventional discs such as heart-shaped, octagonal discs, etc. The disc may not eject resulting in a malfunction.

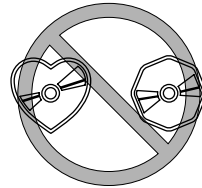

- If the memory portion of the CD is transparent or translucent, do not use the disc.

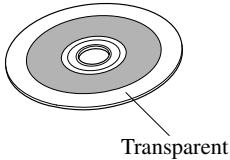

- A new CD may have rough edges on its inner and outer perimeters. If a disc with rough edges is used, proper setting will not be possible and the CD player will not play the CD. In addition, the disc may not eject resulting in a malfunction. Remove the rough edges in advance by using a ball-point pen or pencil as shown in the following figure. To remove the rough edges, rub the side of the pen or pencil against the inner and outer perimeter of the CD.

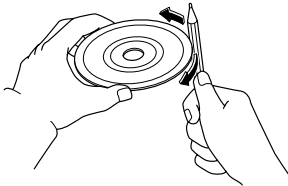

- When driving over uneven surfaces, the sound may jump.

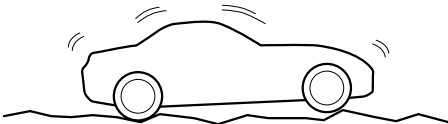

- CDs bearing the logo shown in the illustration can be played. No other discs can be played.



- Use discs that have been legitimately produced. If illegally-copied discs such as pirated discs are used, the system may not operate properly.
- Be sure never to touch the signal surface when handling the CDs. Pick up a CD by grasping the outer edge or the edge of the hole and the outer edge.



- Do not stick paper or tape on the CD. Avoid scratching the reverse side (the side without a label). The disc may not eject resulting in a malfunction.
- Dust, finger smudges, and dirt can decrease the amount of light reflected from the signal surface, thus affecting sound quality. If the CD should become soiled, gently wipe it with a soft cloth from the center of the CD to the edge.
- Do not use record sprays, antistatic agents, or household spray cleaners. Volatile chemicals such as benzine and thinner can also damage the surface of the CD and must not be used. Anything that can damage, warp, or fog plastic should never be used to clean CDs.

Audio System

- The CD player ejects the CD if the CD is inserted upside down. Also dirty and/or defective CDs may be ejected.
- Do not insert cleaning discs in the CD player.
- Do not insert any disc with a peel-off seal affixed to it.
- This unit may not be able to play certain CD-R/CD-RWs made using a computer or music CD recorder due to disc characteristics, scratches, smudges, dirt, etc., or due to dust or condensation on the lens inside the unit.
- Storing CDs in the vehicle exposed to direct sunlight or high temperature may damage the CD-R/CD-RWs, and make them unplayable.
- CD-R/CD-RW exceeding 700 MB cannot be played.
- This unit may not be able to play certain discs made using a computer due to the application (writing software) setting used. (For details, consult the store where the application was purchased.)
- It is possible that certain text data, such as titles, recorded on a CD-R/CD-RW may not be displayed when musical data (CD-DA) is playing.
- The period from when a CD-RW is inserted to when it begins playing is longer than a normal CD or CD-R.
- Completely read the instruction manual and cautions for CD-R/CD-RWs.
- Do not use discs with cellophane tape adhering, partially peeled off labels, or adhesive material exuding from the edges of the CD label. Also, do not use discs with a commercially-available CD-R label affixed. The disc may not eject resulting in a malfunction.

▼ Operating Tips for MP3

MP3 stands for MPEG Audio Layer 3, which is standardized voice compression established by the ISO*1 working group (MPEG).

Use of MP3 allows for audio data to be compressed to approximately a tenth of the source data size.

This unit plays files with the extension (.mp3) as MP3 files.

*1 International Organization for Standardization



Do not use an audio file extension on files other than audio files. In addition, do not change the audio file extension. Otherwise, the unit will not recognize the file correctly resulting in noise or a malfunction.

NOTE

Supply of this product only conveys a license for private, non-commercial use and does not convey a license nor imply any right to use this product in any commercial (i.e. revenue-generating) real time broadcasting (terrestrial, satellite, cable and/or any other media), broadcasting/streaming via the Internet, intranets and/or other networks or in other electronic content distribution systems, such as pay-audio or audio-on-demand applications. An independent license for such use is required. For details, please visit <http://www.mp3licensing.com>.

- This audio system handles MP3 files that have been recorded on CD-R/CD-RW/CD-ROMs.
- When naming an MP3 file, be sure to add an MP3 file extension (.mp3) after the file name.

- The number of characters which can be displayed is restricted.

▼ Operating Tips for WMA

WMA is short for Windows Media*¹ Audio and is the audio compression format used by Microsoft*¹.

Audio data can be created and stored at a higher compression ratio than MP3. This unit plays files with the extension (.wma) as WMA files.

- *1 Windows Media and Microsoft are registered trademarks of Microsoft Corporation U.S. in the United States and other countries.

CAUTION

Do not use an audio file extension on files other than audio files. In addition, do not change the audio file extension. Otherwise, the unit will not recognize the file correctly resulting in noise or a malfunction.

- WMA files written under specifications other than the indicated specification may not play normally or files or folder names may not display correctly.
- The file extension may not be provided depending on the computer operating system, version, software, or settings. In this case, add the file extension “.wma” to the end of the file name, and then write it to the disc/memory.

▼ Operating Tips for AAC

AAC stands for Advanced Audio Coding, which is standardized voice compression established by the ISO*¹ working group (MPEG). Audio data can be created and stored at a higher compression ratio than MP3.

This unit plays files with the extensions (.aac*²/.m4a/.wav*²) as the AAC files.

CAUTION

Do not use an audio file extension on files other than audio files. In addition, do not change the audio file extension. Otherwise, the unit will not recognize the file correctly resulting in noise or a malfunction.

- AAC files written under specifications other than the indicated specification may not play normally or files or folder names may not display correctly.
- The file extension may not be provided depending on the computer operating system, version, software, or settings. In this case, add the file extension “.aac*²”, “.m4a”, or “.wav*²” to the end of the file name, and then write it to the memory.

*1 International Organization for Standardization

*2 Type B

Audio System

▼ Operating Tips for OGG

OGG is the audio compression format for Xiph. Org Foundation.

Audio data can be created and stored at a higher compression ratio than MP3.

This unit plays files with the extension (.ogg) as OGG files.

CAUTION

Do not use an audio file extension on files other than audio files. In addition, do not change the audio file extension. Otherwise, the unit will not recognize the file correctly resulting in noise or a malfunction.

- OGG files written under specifications other than the indicated specification may not play normally or files or folder names may not display correctly.
- The file extension may not be provided depending on the computer operating system, version, software, or settings. In this case, add the file extension “.ogg” to the end of the file name, and then write it to the memory.

▼ Operating Tips for USB device

This unit plays audio files as follows:

Extension	Playback with this unit
.mp3	MP3
.wma	WMA
.aac* ¹	AAC
.m4a	
.wav* ¹	WAV
.ogg* ¹	OGG

CAUTION

Do not use an audio file extension on files other than audio files. In addition, do not change the audio file extension. Otherwise, the unit will not recognize the file correctly resulting in noise or a malfunction.

NOTE

- *Playback may not be possible depending on the type and condition of the USB flash memory even if the audio file complies with the standard.*
- *A copyright protected WMA/AAC file cannot be played in this unit.*
- **(Type B)**
*If a file name in the USB memory is too long, it could cause operation problems such as not being able to playback the song.
(Recommended: Within 80 characters)*
- *The order of the music data stored in the device may differ from the playback order.*
- *To prevent loss or damage of stored data, we recommend that you always back up your data.*
- *If a device exceeds the maximum electric current value of 1,000 mA, it may not operate or recharge when connected.*
- *Do not pull out the USB device while in the USB mode (only pull it out while in FM/AM radio or CD mode).*
- *The device will not operate if the data is password protected.*

MP3/WMA/AAC/OGG*¹ files written under specifications other than the indicated specification may not play normally or files/folder names may not display correctly.

*1 Type B

▼ Operating Tips for iPod

This unit supports playback of music files recorded to an iPod.

* iPod is a trademark of Apple Inc., registered in the U.S. and other countries.

The iPod may not be compatible depending on the model or OS version. In this case, an error message is displayed.

CAUTION

- *Remove the iPod when it is not in use. Because the iPod is not designed to withstand excessive changes in temperature inside the cabin, it could be damaged or the battery may deteriorate due to the excessive temperature or humidity inside the cabin if it is left in the vehicle.*
- *If data in the iPod is lost while it is connected to the unit, Mazda cannot guarantee recovery of any lost data.*
- *If the iPod battery is deteriorated, the iPod may not recharge and playback may not be possible when it is connected to the unit.*
- *For details on using the iPod, refer to the iPod instruction manual.*
- *When connecting the iPod to a USB port, all commands are made from the audio unit. iPod control is not possible.*

NOTE

The audio unit cannot display images or videos stored in an iPod.

Audio System

Audio set [Type A (non-touchscreen)]

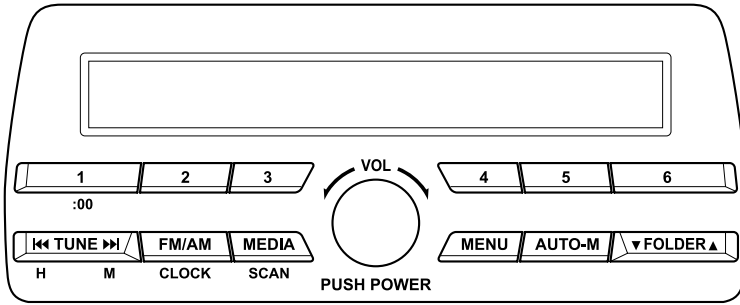

① Power/Volume/Sound Controls.....	page 5-24
② Clock	page 5-26
③ Operating the Radio	page 5-28
④ Operating the Compact Disc (CD) Player.....	page 5-30
⑤ How to use Auxiliary jack/USB port	page 5-33
⑥ Error Indications	page 5-33

MEMO

Audio System

▼ Power/Volume/Sound Controls

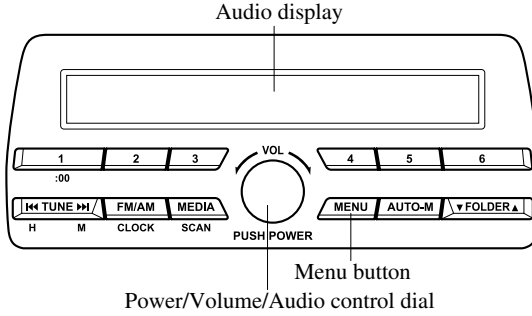

Power ON/OFF

Switch the ignition to ACC or ON. Press the power/volume dial to turn the audio system on. Press the power/volume dial again to turn the audio system off.

Volume adjustment

To adjust the volume, turn the power/volume dial. Turn the power/volume dial clockwise to increase volume, counterclockwise to decrease it.

Audio sound adjustment

1. Press the menu button (**MENU**) to select the function. The selected function will be indicated.

2. Turn the audio control dial to adjust the selected functions as follows:

Indication	Setting value	
	Turn Counterclockwise	Turn Clockwise
ALC (Automatic volume adjustment)	Level decrease	Level increase
BASS (Low pitch sound)	Decrease bass	Increase bass
TREB (Treble sound)	Decrease treble	Increase treble
FADE (Front/back volume balance)	Shift the sound to the front	Shift the sound to the rear
BAL (Left/right volume balance)	Shift the sound to the left	Shift the sound to the right
BEEP (Audio operation sound)	Off	On
BT SETUP*	Select mode	
12Hr < > 24Hr (12 Hr/24 Hr time adjustment)	12Hr (Flashing)	24Hr (Flashing)

* Depending on the model, this function may not be available.

NOTE

If not operated for several seconds, the display returns to the previous display. To reset bass, treble, fade, and balance, press the menu button (MENU) for 2 seconds. The unit will beep and "CLEAR" will be displayed.

ALC (Automatic volume adjustment)

The automatic level control (ALC) changes the audio volume automatically according to the vehicle speed. The faster the vehicle speed, the higher the volume increases. ALC has ALC OFF and ALC LEVEL 1 to 7 modes. At ALC LEVEL 7, the amount that the volume can increase is at the maximum. Select the mode according to the driving conditions.

BEEP (Audio operation sound)

The setting for the operation sound when pressing and holding a button can be changed. The initial setting is ON. Set to OFF to mute the operation sound.

BT SETUP mode*

Music and other audio such as voice data recorded on portable audio devices and mobile phones available on the market which are equipped with the Bluetooth® transmission function can be listened to via wireless transmission over the vehicle's speakers. Using the BT SETUP mode, these devices can be programmed to the Bluetooth® unit or changed (page 5-77).

12Hr < > 24Hr (12 Hr/24 Hr time adjustment)

Rotating the audio control dial switches the display between 12 and 24-hour clock time (page 5-26).

Audio System

▼ Clock

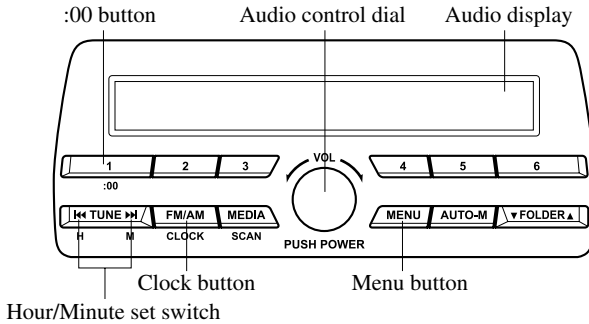

Setting the time

The clock can be set at any time when the ignition is switched to ACC or ON.

1. To adjust the time, press the clock button (**FM/AM**) for about 2 seconds until a beep is heard.
2. The clock's current time will flash.

Time adjustment

- To adjust the time, press the hour/minute set button (**◀▶**) while the clock's current time is flashing.
 - The hours advance while the hour set button (**◀**) is pressed. The minutes advance while the minute set button (**▶**) is pressed.
3. Press the clock button (**FM/AM**) again to start the clock.

Time resetting

1. Press the clock button (**FM/AM**) for about 2 seconds until a beep is heard.
2. Press the :00 button (1).
3. When the button is pressed, the time will be reset as follows:
(Example)
12:01—12:29→12:00
12:30—12:59→1:00

NOTE

- When the :00 button (1) is pressed, the seconds will start at "00".
- Switching between 12 and 24-hour clock time:
Press the menu button (**MENU**) several times until 12 and 24-hour clock time are displayed. Turn the audio control dial in either direction, select the desired clock setting while the preferred clock time is flashing.

MEMO

Audio System

▼ Operating the Radio

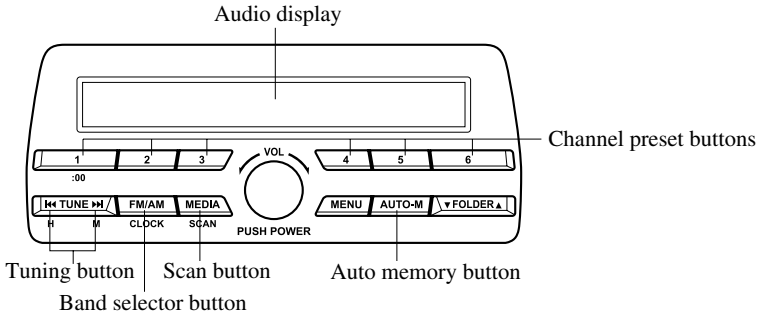

Radio ON

Press a band selector button (**FM/AM**) to turn the radio on.

Band selection

Successively pressing the band selector button (**FM/AM**) switches the bands as follows: FM1→FM2→AM.

The selected mode will be indicated.

NOTE

If the FM broadcast signal becomes weak, reception automatically changes from STEREO to MONO for reduced noise.

Tuning

The radio has the following tuning methods: Manual, Seek, Scan, Preset channel, and Auto memory tuning. The easiest way to tune stations is to set them on preset channels.

Manual tuning

Select the station by pressing the tuning button (**◀▶**) lightly.

Seek tuning

Automatic search for radio stations starts when the tuning button (**◀▶**) is pressed until a beep sound is heard. The search stops when a station is found.

NOTE

If you continue to press and hold the button, the frequency will continue changing without stopping.

Scan tuning

Press and hold the scan button (**MEDIA**) to automatically sample strong stations. Scanning stops at each station for about 5 seconds. To hold a station, press and hold the scan button (**MEDIA**) again during this interval.

Preset channel tuning

The 6 preset channels can be used to store 6 AM and 12 FM stations.

1. To set a channel first select AM, FM1, or FM2. Tune to the desired station.
2. Press a channel preset button for about 2 seconds until a beep is heard. The preset channel number or station frequency will be displayed. The station is now held in the memory.

3. Repeat this operation for the other stations and bands you want to store. To tune one in the memory, select AM, FM1, or FM2 and then press its channel preset button. The station frequency or the channel number will be displayed.

Auto memory tuning

This is especially useful when driving in an area where the local stations are not known.

Press and hold the auto memory button (**AUTO-M**) for about 2 seconds until a beep is heard; the system will automatically scan and temporarily store up to 6 stations with the strongest frequencies in each selected band in that area.

After scanning is completed, the station with the strongest frequency will be tuned and its frequency displayed. Press and release the auto memory button (**AUTO-M**) to recall stations from the auto-stored stations. One stored station will be selected each time and its frequency and channel number will be displayed.

NOTE

If no stations can be tuned after scanning operations, "A" will be displayed.

Audio System

▼ Operating the Compact Disc (CD) Player

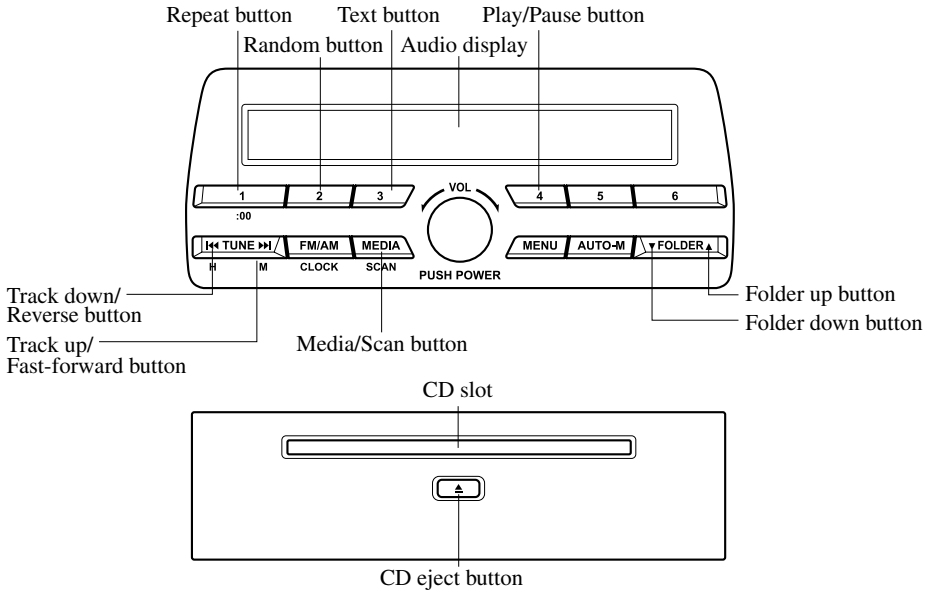

Type	Playable data
Music/MP3/WMA/AAC CD player	<ul style="list-style-type: none"> •Music data (CD-DA) •MP3/WMA/AAC file

NOTE

If a disc has both music data (CD-DA) and MP3/WMA/AAC files, playback of the two or three file types differs depending on how the disc was recorded.

Inserting the CD

Insert the CD into the slot, label-side up. The auto-loading mechanism will set the CD and begin play.

NOTE

There will be a short lapse before play begins while the player reads the digital signals on the CD.

Ejecting the CD

Press the CD eject button (▲) to eject the CD.

Playback

Press the media button (**MEDIA**) to switch to CD mode and start playback.

NOTE

The CD mode cannot be selected if a CD has not been inserted.

Pause

To stop playback, press the Play/Pause button (4).

Press the button again to resume playback.

Fast-forward/Reverse

Press and hold the fast-forward button (▶▶) to advance through a track at high speed. Press and hold the reverse button (◀◀) to reverse through a track at high speed.

Track search

Press the track up button (▶) once to skip forward to the beginning of the next track. Press the track down button (◀) within a few seconds after playback begins to track down to the beginning of the previous track.

Press the track down button (◀) after a few seconds have elapsed to start playback from the beginning of the current track.

Folder search (during MP3/WMA/AAC CD playback)

To change to the previous folder, press the folder down button (▼), or press the folder up button (▲) to advance to the next folder.

Music scan**During music CD playback**

This function scans the titles on a CD and plays 10 seconds of each song to aid you in finding a song you want to listen to. Press and hold the scan button (MEDIA) during playback to start the scan play operation (the track number will flash). Press and hold the scan button (MEDIA) again to cancel scan playback.

During MP3/WMA/AAC CD playback

This function scans the titles in a folder currently being played and plays 10 seconds of each song to aid you in finding a song you want to listen to. Press and hold the scan button (MEDIA) during playback to start the scan play operation (the track number will flash). Press and hold the scan button (MEDIA) again to cancel scan playback.

NOTE

If the unit is left in scan, normal playback will resume where scan was selected.

Repeat playback**During music CD playback**

1. Press the repeat button (1) during playback to play the current track repeatedly. "TRACK RPT" is displayed (♫ is displayed next to RPT at the bottom of the display area).
2. Press the button again to cancel the repeat playback.

During MP3/WMA/AAC CD playback**(Track repeat)**

1. Press the repeat button (1) during playback to play the current track repeatedly. "TRACK RPT" is displayed (♫ is displayed next to RPT at the bottom of the display area).
2. To cancel the repeat playback, press the button again after 3 seconds.

Audio System

(Folder repeat)

1. Press the repeat button (1) during playback, and then press the button again within 3 seconds to play the tracks in the current folder repeatedly. “FOLDER RPT” is displayed (📁 is displayed next to RPT at the bottom of the display area).
2. Press the button again to cancel the repeat playback.

Random playback

Tracks are randomly selected and played.

During music CD playback

1. Press the random button (2) during playback to play the tracks on the CD randomly. “DISC RDM” is displayed (🎵 is displayed next to RDM at the bottom of the display area).
2. Press the button again to cancel the random playback.

During MP3/WMA/AAC CD playback

(Folder random)

1. Press the random button (2) during playback to play the tracks in the folder randomly. “FOLDER RDM” is displayed (📁 is displayed next to RDM at the bottom of the display area).
2. To cancel the random playback, press the button again after 3 seconds.

(CD random)

1. Press the random button (2) during playback, and then press the button again within 3 seconds to play the tracks on the CD randomly. “DISC RDM” is displayed (🎵 is displayed next to RDM at the bottom of the display area).
2. Press the button again to cancel the random playback.

Switching the display

The information displayed on the audio display changes as follows each time the text button (3) is pressed during playback.

Music CD

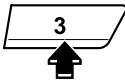
Button	Information displayed on audio display
	Track number/Elapsed time
	Track number
	Track name
	Album name
	Artist name

MP3/WMA/AAC CD

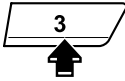
Button	Information displayed on audio display
	File number/Elapsed time
	Folder number/File number
	File name
	Folder name
	Album name
	Song name
Artist name	

NOTE

- *The information viewable in the display is only CD information (such as artist name, song title) which has been recorded to the CD.*
- *This unit cannot display some characters. Characters which cannot be displayed are indicated by an asterisk (*).*

Display scroll

Only 13 characters can be displayed at one time. To display the rest of the characters of a long title, press and hold the text button (3). The display scrolls the next 13 characters. Press and hold the text button (3) again after the last 13 characters have been displayed to return to the beginning of the title.

NOTE

The number of characters which can be displayed is restricted.

Message display

If “CHECK CD” is displayed, it means that there is some CD malfunction. Check the CD for damage, dirt, or smudges, and then properly reinsert it. If the message appears again, insert another known good CD. If the message continues to appear, take the unit to an Authorized Mazda Dealer for service.

▼ How to use Auxiliary jack/USB port

Audio can be heard from the vehicle's speakers by connecting a commercially-available portable audio unit to the auxiliary jack.

Use a commercially-available, non-impedance (3.5 ϕ) stereo mini plug cable. Contact an Authorized Mazda Dealer for details.

In addition, audio can be played from the vehicle audio device by connecting a USB device to the USB port.

Refer to AUX/USB mode on page 5-57.

▼ Error Indications

If you see an error indication on the audio display, find the cause in the chart. If you cannot clear the error indication, take the vehicle to an Authorized Mazda Dealer.

Indication	Cause	Solution
CHECK CD	CD is inserted upside down	Insert the CD properly. If the error indication continues to display, consult an Authorized Mazda Dealer.
	CD is defective	Insert another CD properly. If the error indication continues to display, consult an Authorized Mazda Dealer.

Audio System

Audio set [Type B (touchscreen)]

NOTE

The explanation of functions described in this manual may differ from the actual operation, and the shapes of screens and buttons and the letters and characters displayed may also differ from the actual appearance.

Additionally, depending on future software updates, the content may successively change without notice.

Audio Set (Type B) has three different human interfaces.

- Commander switch
- Touch panel
- Voice recognition with steering switch and microphone

Commander switch operation

NOTE

For safety reasons, some operations are disabled while the vehicle is being driven.

Volume dial operation

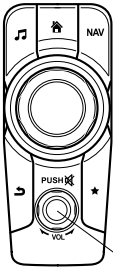

Volume dial

Press the volume dial to switch the audio MUTE on and off.

Turn the volume dial to adjust the volume. The volume increases by turning the dial clockwise, and decreases by turning it counterclockwise.

Switches around commander knob

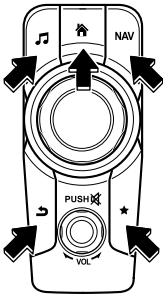

The following operations can be done by pressing the switches around the commander knob.

🏠 : Displays the home screen.

🎵 : Displays the Entertainment screen.

NAV : Displays the Navigation screen (Only navigation-equipped vehicles). For operation of the Navigation screen, refer to the navigation system manual. If the SD card for the navigation system is not inserted, the compass indicating the direction in which the vehicle is moving is displayed.

★ : Displays the Favorites screen. Long-press to store particular items in Favorites. (Radio, phonebook and destination of the navigation system can be programmed.)

↶ : Returns to previous screen.

Commander knob operation

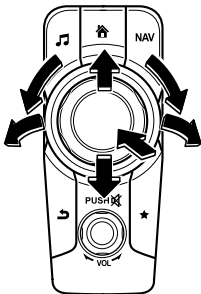

Audio System

(Selection of icons on screen)

1. Tilt or turn the commander knob and move the cursor to the desired icon.
2. Press the commander knob and select the icon.

NOTE

Long-press operation of the commander knob is also possible for some functions.

Touch panel operation



Do not press the screen strongly or press it with a sharp-pointed object. Otherwise, the screen could be damaged.

NOTE

For safety reasons, operation of the center display is disabled while the vehicle is being driven. However, items not displayed in gray can be operated using the commander switch while the vehicle is being driven.

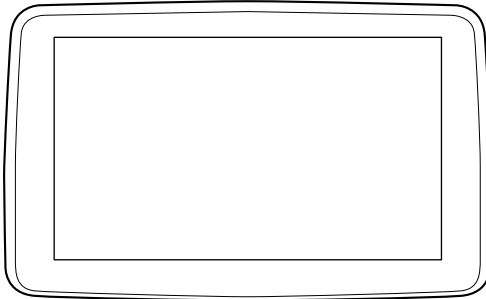

▼ Basic Operation Method

TOUCH & TAP

1. Touch or tap on the item indicated on the screen.
2. The operation is launched and the next item is displayed.

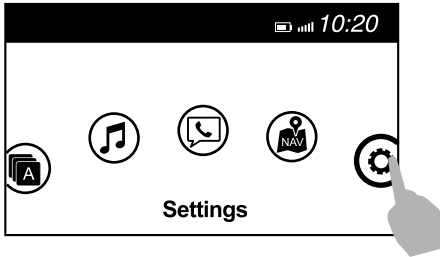

SLIDE

1. Touch the setting item displaying a slider bar.
2. Touch the slider with your finger and move to the desired level.

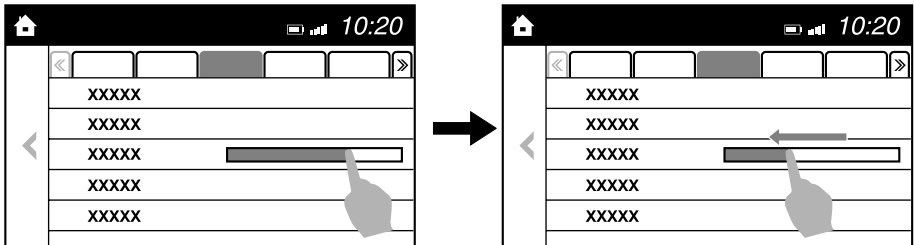

SWIPE

1. Touch the screen with your finger and move up or down.
2. Items which were not displayed can be displayed.

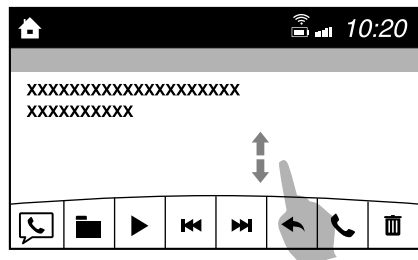
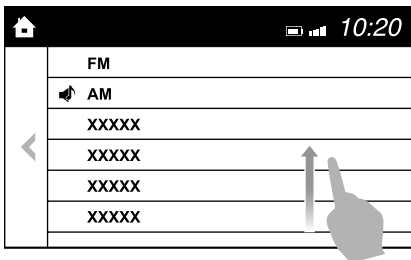

Audio System







Return to previous screen

1. Touch the .

Displaying the home screen

1. Touch the .

▼ Home screen

Icon	Function
	<p>Applications Information such as average fuel economy, maintenance, and warnings can be verified. Depending on the grade and specification, the screen display may differ.</p>
	<p>Entertainment Operates audio such as the radio and CDs. The audio source most recently used is displayed. An audio source which cannot be used at that time is skipped and the previous audio source is displayed. To change the audio source, select the  icon displayed at the bottom of the screen.</p>
	<p>Communication Bluetooth® related functions are available.</p>
	<p>Navigation Navigation screen is displayed (vehicles with navigation system). If the SD card for the navigation system is not inserted, the compass indicating the direction in which the vehicle is moving is displayed. The compass may not indicate the correct bearing when the vehicle is stopped or traveling at a slow speed.</p>
	<p>Settings Overall setting menu (Such as display, sound, Bluetooth® and Language). Depending on the grade and specification, the screen display may differ.</p>

MEMO

Audio System

▼ Volume/Display/Sound Controls

Commander switch

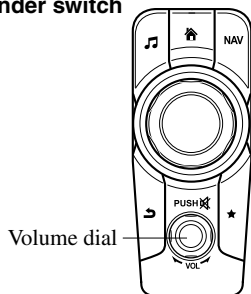

Audio control switch

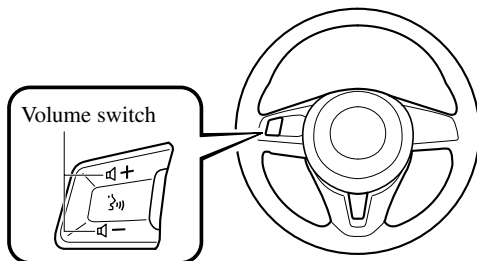

Volume adjustment

Turn the commander switch volume dial. The volume switch on the steering switch can also be pressed.

Display setting

Select the  icon on the home screen to display the Settings screen. Select the **Display** tab to select the item you would like to change.

Display OFF/Clock

The center display can be turned off. Select **Turn Display Off** to turn the display off. When **Turn Display Off and Show Clock** is selected the center display turns off and the clock is displayed. The center display can be turned back on as follows:

- Touch the center display.
- Operate the commander switch.

Daytime/nighttime (System) screen setting

The daytime or nighttime screen can be selected.

Auto : Switches screen automatically according to headlight illumination condition*1

Day : Daytime screen setting

Night : Nighttime screen setting

*1 The display is constantly on daytime screen when the illumination dimmer is cancelled.

Brightness adjustment

Adjust the center display brightness using the slider.

Contrast adjustment

Adjust the center display contrast using the slider.

Display setting reset

All of the screen setting values can be reset to their initial settings.

1. Select **Restore Factory settings**.
2. Select **Yes**.

Audio sound adjustment

Select the  icon on the home screen to display the Settings screen.

Select the **Sound** tab to select the item you would like to change.

Indication	Setting value
Bass (Low pitch sound)	+ Side: Low pitch enhancement - Side: Low pitch reduction
Treble (Treble sound)	+ Side: Treble enhancement - Side: Treble reduction
Fade (Front/Rear volume balance)	Front: Front speaker volume enhancement Rear: Rear speaker volume enhancement
Balance (Left/right volume balance)	Right: Right speaker volume enhancement Left: Left speaker volume enhancement
ALC*1 (Automatic volume adjustment)	Off—Adjustment at seven levels
Bose® AudioPilot*2 (Automatic volume adjustment)	On/Off
Beep (Audio operation sound)	On/Off

*1 Standard audio

*2 Bose® Sound System

ALC (Automatic volume adjustment)

The automatic level control (ALC) is a feature that automatically adjusts audio volume and sound quality according to the vehicle speed. The volume increases in accordance with the increase in vehicle speed, and decreases as vehicle speed decreases.

Bose® AudioPilot (Automatic volume adjustment)

When driving, background noise can interfere with enjoying music.

AudioPilot®*3 noise compensation technology continuously adjusts the music to compensate for background noise and vehicle speed.

It reacts only to sustained noise sources and not intermittent ones, such as speed bumps.

An enhanced DSP algorithm allows faster and more effective compensation for unusual situations, such as driving on a very rough road or at high speeds.

In addition, a system is equipped which switches the audio to the optimum acoustics corresponding to the opening and closing of the soft top/roof.

The acoustic switching function is linked to the operation of the top lock lever/retractable fastback switch and audio playback is muted for about 1 second while switching.











*3 AudioPilot® is a registered trademark of Bose Corporation.

Audio System

▼ Operating the Radio

Radio ON

Select the  icon on the home screen to display the Entertainment screen. When selecting the desired radio, the following icons are indicated in the lower part of the center display.
AM/FM Radio

Icon	Function
	Displays the Entertainment menu. Use to switch to a different audio source.
	Displays the station list. Select Update Station List to display the frequencies of up to ten radio stations on the auto memory preset list. Select the desired frequency.
	Displays the Favorites list. Long-press to store radio station currently being aired.
	Switches the HD Radio on and off. Displays the multi-cast channel list of the HD Radio .
	You can search for receivable radio stations. Scanning stops at each station for about five seconds. Select again to continue receiving the radio station.
	You can change the radio frequency manually. Rotate the commander knob, slide the screen, or touch the radio frequency. Press ◀ or ▶ to change the radio frequency one step at a time. When ◀ or ▶ is long-pressed, the radio frequency changes continually. It stops when you remove your hand from the icon or the commander knob.
	Launches the iTunes Tagging function (for Apple devices with USB use only). Can be used when the HD Radio is on.
	Automatic radio station selection. When long-pressed, the radio frequency changes continually. It stops when you remove your hand from the icon or the commander knob.
	
	Displays sound settings to adjust audio quality level. Refer to Volume/Display/Sound Controls on page 5-40.

Favorites Radio

Selected stations can be registered for convenient operation. Up to 50 stations can be registered. The Favorites list is common to AM, FM, and satellite radio.

Registering to Favorites

Long-press the ★ icon to register the current radio station. The registration can also be performed using the following procedure.

1. Select the ★ icon to display the Favorites list.
2. Select **Add/Edit Radio Favorites**.
3. Select **Add <active station>**.
4. The station is added to the bottom of the Favorites list.

NOTE

If the battery is disconnected, your Favorites list will not be deleted.

Selecting radio station from Favorites

1. Select the ★ icon to display the Favorites list.
2. Select the radio frequency to tune in the radio station.

Deleting from Favorites

1. Select the ★ icon to display the Favorites list.
2. Select **Add/Edit Radio Favorites**.
3. Select **Delete**.
4. Select the radio frequency you want to delete.
5. Select **Delete**.

Changing Favorites list order

1. Select the ★ icon to display the Favorites list.
2. Select **Add/Edit Radio Favorites**.
3. Select **Move**.
4. Select a radio frequency. The selected radio station can be moved.
5. Slide the radio station or move it using the commander switch, then select **OK**.

Radio Broadcast Data System (RBDS)*

Radio text information display

Radio text information sent from a broadcasting station is displayed in the center display.

NOTE

Radio text information is a function of FM radio only. There is no text function on AM radio. Text information is not displayed in the following:

- During HD Radio reception
- Not an RBDS broadcast
- RBDS broadcast, but radio text is not transmitted from the radio station

Genre Seek

Some FM stations transmit Genre codes (Program type like a Rock, News, and so on). This code enables alternative stations transmitting the same Genre code to be found quickly.

(To scan for Genre Seek:)

1. Select the 📶 icon while in the FM mode.
2. Select **Genre Seek** to open the genre list.
3. Select the genre type you want to select.
4. Select the ⏪, ⏩ icon.

Audio System

NOTE

To change the desired genre, select the  icon.

Ex.)

89.3 is currently being received. With Rock selected as the Genre, the radio stations broadcasting Rock are at the following frequencies.

98.3*1, 98.7, 104.3*1, 107.1

*1 Radio stations with good reception

The frequency changes as follows each time **Genre Seek** is pressed.

89.3→98.3→104.3→98.3

NOTE

- Only one Genre can be selected.
- It may not be possible to receive any station even if the Genre Seek function is used.
- If a program in the selected genre is not broadcast to a region, reception is not possible even if the Genre Seek function is used.
- The Genre Seek function searches for genre code (program type) which FM analog broadcasts transmit. HD Radio specialty programs (HD2-HD8) cannot be searched because they are not FM analog broadcasts.
- If radio stations which are selected by scanning using the Genre Seek function are HD Radio broadcasting stations, they are changed from analog broadcasts to HD Radio broadcasts after a few seconds if the reception conditions are good. The genre is displayed after the switch, however, the genre for FM analog broadcasts may differ.

HD Radio

What is HD Radio™ Technology and how does it work?

HD Radio™ Technology is the digital evolution of analog AM/FM radio. Your radio product has a special receiver which allows it to receive digital broadcasts (where available) in addition to the analog broadcasts it already receives. Digital broadcasts have better sound quality than analog broadcasts as digital broadcasts provide free, crystal clear audio. For more information, and a guide to available radio stations and programming, please visit www.hdradio.com.

Benefits of HD Radio™ Technology (Information)



The song title, artist name, album name and genre will appear on the screen when available by the radio station.

(Multicast)

On the FM radio frequency most digital stations have “multiple” or supplemental programs on each FM station.

Listening to HD Radio™ Technology





If  icon turns on by selecting a radio station which is an HD Radio broadcasting station, the analog broadcast is switched to an HD Radio broadcast automatically after a few seconds and then received.

If the HD Radio broadcast is stopped and changed to an analog broadcast, press down  to turn off .

Multicast channel selection (FM)

If multi-cast channels are available for an HD Radio broadcast currently being received, the multi-cast channel list is displayed. Select the desired radio station.

NOTE

- *If an analog broadcast is received once and HD Radio is received while HD1 is selected, the audio unit switches to the HD Radio station automatically.*
- *When the  icon is illuminated, there could be a noticeable difference in sound quality and volume when a change from digital to analog signals occurs. If the sound quality and volume become noticeably diminished or cut off, select the  icon to turn off HD Radio ( icon is not illuminated).*
- *Once an analog broadcast is received when HD1 is selected from the Favorite channels, it is switched to HD Radio automatically. If the radio reception conditions are poor, or HD is off, switching to HD Radio broadcasts is not possible.*
- *When an HD specialty channel (HD2 to HD8) is selected from the Favorite channels, "Signal Lost" is displayed and no audio is output until HD Radio is received. If the radio reception conditions are poor, "Signal Lost" continues to be displayed.*
- *If the  icon is not illuminated, information such as song titles of the HD Radio station are received, however, the audio output is analog.*

iTunes Tagging (for Apple devices with USB use only)

By tagging a song currently being aired, the song can later be purchased from the iTunes Store. One hundred tags can be stored. A maximum of 100 tags (for 100 songs) can be stored for later downloading.

1. Select the  icon. The tag is stored in the audio unit.
2. Connect the device via the vehicle's USB. Any stored tag(s) will be sent automatically to the connected device.
3. Once at home or after parking the vehicle safely, log onto the iTunes Store with your device. Your previously tagged song(s) can now be easily purchased.

NOTE

- *Both AM and FM HD Radio can be used.*
- *Because iTunes tagging only supports purchases from the iTunes Store, direct downloading of music from the vehicle's audio unit is not possible.*
- *If the available memory for the connected device is insufficient, the tag is not sent.*
- *If an error occurs while the tag is being sent, reconnect the device.*

Audio System

▼ Operating the Satellite Radio*

What is satellite radio?

With over 130 channels, SiriusXM Satellite Radio brings you more of what you love. Get channels and channels of commercial-free music, plus sports, news, talk, entertainment and more.

Commercial-free music from nearly every genre —rock to pop, hip-hop to country, jazz, classical and more. Plus live performances and artist-dedicated channels.

Live sports Play-by-Play & Expert Talk —every NFL game, every NASCAR® race, 24/7 sports talk, college sports and more.

Exclusive entertainment, comedy and talk —The biggest names, compelling talk, hilarious comedy.

World-class news plus local traffic and weather.

Sign up for SiriusXM Satellite Radio today!

NOTE

- *To listen to SiriusXM, a prior subscription (fee-based) is required.*
- *The channels which you can receive depend on the package you subscribe to.*
- *Satellite radio is broadcast as Sirius, XM, and SiriusXM in the U.S.A., and Sirius and XM in Canada. In this owner's manual, only the name SiriusXM is used.*

- *For traffic and weather channels, map information is not displayed and only audio broadcasts can be received.*
- *Call 877-447-0011 (U.S.A.)/877-209-0079 (Canada) to activate. For more information, visit www.siriusxm.com (U.S.A.)/www.siriusxm.ca (Canada). Satellite radio is only available in regions providing satellite radio service (some areas of the United States and Canada). Contact Authorized Mazda Dealer for details.*

How to Activate Satellite Radio

You must call SiriusXM to activate your service. Activation is free and takes only a few minutes.

New customers can receive a free introductory subscription with a limited term trial offer by calling 877-447-0011 (U.S.A.)/877-209-0079 (Canada) to activate.

SiriusXM service uses an ID code to identify your radio. This code is needed to activate SiriusXM service, and report any problems.

Please have the following information ready:



- Radio ID (8-digit electronic serial No.) Refer to Displaying the Radio ID (ESN)
- Valid credit card information (may not be required at initial sign-up)









Be sure you are parked outside with a clear view of open sky, you will be instructed to turn on your radio (in SiriusXM mode and tuned to channel 184 (Sirius)/1 (XM and SiriusXM)). Activation typically takes only 2—5 minutes.

Displaying the Radio ID (ESN)

When channel 0 is selected, the radio ID is displayed. Use the PREVIOUS or NEXT channel buttons to select channel 0.

SiriusXM operation

Select the  icon on the home screen to display the Entertainment screen. When  is selected, the following icons are indicated in the bottom part of the center display.

Icon	Function
	Displays the Entertainment menu. Use to switch to a different audio source.
	Displays the channel list of the current category.
	Displays the favorites list. Long-press to store the channel currently being aired. Refer to Operating the Radio on page 5-42.
	Indicates that the parental lock function is in use. Switching of Lock/Unlock and PIN code setting changes can be performed.
	Plays each channel in the current channel list for 5 seconds. Select again to continue receiving the channel.
	Plays the previous channel.
	Plays the next channel.
	Displays sound settings to adjust audio quality level. Refer to Volume/Display/Sound Controls on page 5-40.

Audio System

Selection from channel list

Receivable channels can be displayed on the channel list screen. You can easily select the channel you want to listen from the list. Each category can be also displayed.

1. Select the  icon to display the channel list.
2. Select a desired channel.

(Select from category list)

1. Select the  icon to display the channel list.
2. Select **Category:** to display the category list.
3. Select a desired category.

Parental lock

If a channel is locked, the channel is muted.

To use the parental lock function, the PIN code must be initialized first.

By using the session lock, the parental lock can be enabled or disabled during the current drive cycle (from when the ignition is switched on to switched off). When the session lock is on, the parental lock is available. When the session lock is off, the parental lock is temporarily cancelled.

When canceling the parental lock or session lock, or when changing the PIN code, PIN code input is required.

PIN code reset

If the registered code has been forgotten, reset the code to the default [0000] code.

1. Select the  icon.
2. If the selected channel is locked, input the PIN code to cancel the parental lock temporarily.
3. Select **Reset PIN Code**.
4. Input the default code [0000] using the number buttons.
5. Select **OK**.
6. Input the new PIN code using the number buttons.
7. Select **OK**.

MEMO

Audio System

▼ Operating the Compact Disc (CD) Player

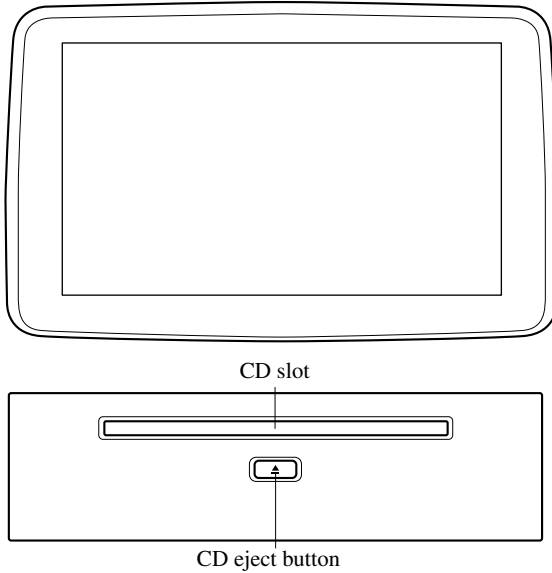

Type	Playable data
Music/MP3/WMA/AAC CD player	<ul style="list-style-type: none"> •Music data (CD-DA) •MP3/WMA/AAC file

NOTE

If a disc has both music data (CD-DA) and MP3/WMA/AAC files, playback of the two or three file types differs depending on how the disc was recorded.

Inserting the CD

Insert the CD into the slot, label-side up. The auto-loading mechanism will set the CD and begin play.



NOTE







There will be a short lapse before play begins while the player reads the digital signals on the CD.

Ejecting the CD





Press the CD eject button (▲) to eject the CD.

Playback

Select the  on the home screen with a CD inserted and display the Entertainment screen. When  is selected, the following icons are indicated in the lower part of the center display.

Icon	Function
	Displays the Entertainment menu. Use to switch to a different audio source.
	(Music CD) Displays the track list of the CD. Select the track you want to play. (MP3/WMA/AAC CD) Displays the top level folder/file list. Select the folder you want to select. The files in the selected folder are displayed. Select the file you want to play.
	(MP3/WMA/AAC CDs only) Displays the file list of the folder currently being played. Select the song you want to listen to.
	(Music CD) Replays the song currently being played repeatedly. Select it again to cancel. (MP3/WMA/AAC CD) Replays the song currently being played repeatedly. When selected again, the songs in the folder are played repeatedly. Select it again to cancel.
	(Music CD) Plays songs on the CD in random order. Select it again to cancel. (MP3/WMA/AAC CD) Plays songs in the folder in random order. When selected again, the songs on the CD are played in random order. Select it again to cancel.
	(Music CD) The beginning of each track on a CD is played to aid in searching for a desired track. When selected again, the operation is canceled and the song currently being played continues. (MP3/WMA/AAC CD) The beginning of each track in a folder is played to aid in searching for a desired track. When selected again, the operation is canceled and the song currently being played continues. If the audio is operated during scan-play, the track being scan-played is played normally. Then, the audio operation is performed.

Audio System

Icon	Function
	If selected within a few seconds of a song which has started to play, the previous song is selected. If more than a few seconds have elapsed after a song has begun to play, the song currently being played is replayed from the beginning. Long-press to fast reverse. It stops when you remove your hand from the icon or the commander knob.
	Plays a CD. When selected again, playback is temporarily stopped.
	Advances to the beginning of the next song. Long-press to fast forward. It stops when you remove your hand from the icon or the commander knob.
	Displays sound settings to adjust audio quality level. Refer to Volume/Display/Sound Controls on page 5-40.

Example of use (When searching for a song from the top level of an MP3/WMA/AAC CD)

1. Select the  icon to display the folder/file list at the top level.

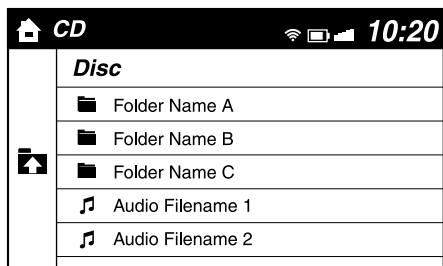

2. When the folder is selected, folders/file lists in the folder are displayed.
3. Select the desired song.

NOTE

- Select  to move to a folder one level higher.
- The appearance of the repeat and shuffle icons changes depending on the type of operation in which the function is used.

▼ How to use Auxiliary jack/USB port

Audio can be heard from the vehicle's speakers by connecting a commercially-available portable audio unit to the auxiliary jack.

Use a commercially-available, non-impedance (3.5 ϕ) stereo mini plug cable. In addition, audio can be played from the vehicle audio device by connecting a USB device to the USB port.

Refer to AUX/USB mode on page 5-57.

▼ **Settings**

NOTE

Depending on the grade and specification, the screen display may differ.

Select the  icon on the home screen to display the Settings screen.
Switch the tab and select the setting item you want to change.
You can customize settings in the setup display as follows:

Tab	Item	Function
Display	Refer to Volume/Display/Sound Controls on page 5-40.	
Safety	Blind Spot Monitoring Volume Other	Refer to Personalization Features on page 9-9.
Sound	Refer to Volume/Display/Sound Controls on page 5-40.	
Clock	Adjust Time	Displays the currently set time is displayed. Press + to advance the hour/minute, and select - to move the hour/minute back. AM/PM can only be selected with the 12-hour clock display.
	GPS Sync	Synchronizes with GPS when turned on. When turned off, the time can be changed from “Adjust Time”.
	Time Format	Changes the display between 12 and 24-hour clock time.
	Time Zone Select	When it's not synchronized with GPS, select the region you want to specify.
	Daylight Savings Time	Turns the daylight saving time setting on/off. When ON, the time advances 1 hour. When OFF, it returns to normal time.
Vehicle	Rain Sensing Wiper Door Locks Other	Refer to Personalization Features on page 9-9.
Devices	Bluetooth®	Refer to Bluetooth® Preparation (Type B) on page 5-91.

Audio System

Tab	Item		Function
System	Tool Tips		Turns button explanations ON/OFF.
	Language		Changes the language.
	Temperature		Changes the setting between Fahrenheit and Celsius.
	Distance		Changes the setting between miles and kilometers.
	Music Database Update		Used to update Gracenote®. Gracenote is used with USB Audio, and provides: 1. Supplemental music information (Such as song name, artist name) 2. Voice recognition assistance for Play Artist and Play Album Gracenote can be downloaded from the Mazda Handsfree Website. Refer to Gracenote Database (Type B) on page 5-71.
	Restore All Factory Settings		Memory and settings are initialized to the factory settings. The initialization launches by selecting the Yes button.
	About	Agreements and Disclaimers	Verify the disclaimer and agree.
Version Information		Can verify the current audio unit OS version and Gracenote Database version.	

▼ Applications

NOTE

Depending on the grade and specification, the screen display may differ.

Select the  icon on the home screen to display the Applications screen. The following information can be verified.

Top screen		Item	Function
HD Radio™ Traffic Map		—	—
Fuel Economy Monitor		Fuel Consumption Settings	Refer to Fuel Economy Monitor on page 4-69.
Vehicle Status Monitor	Maintenance	Scheduled Maintenance Tire Rotation Oil Change	Refer to Maintenance Monitor (Type B audio) on page 6-20.
	Warning Guidance	Warnings currently active can be verified.	Refer to If a Warning Light Turns On or Flashes on page 7-33.

Audio Control Switch Operation

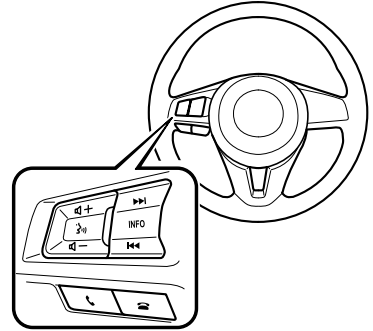

▼ Adjusting the Volume

To increase the volume, press up the volume switch (+).

To decrease the volume, press down the volume switch (-).

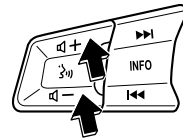

Audio System

▼ Seek Switch

AM/FM radio

Press the seek switch (⏪, ⏩). The radio switches to the next/previous stored station in the order that it was stored.

Press and hold the seek switch (⏪, ⏩) to seek all usable stations at a higher or lower frequency whether programmed or not.

Radio stations which have been previously stored in the auto memory tuning (Type A)/favorite radio (Type B) can be called up by pressing the seek switch (⏪, ⏩) while any radio station stored in the auto memory tuning (Type A)/favorite radio (Type B) is being received. Radio stations can be called up in the order they were stored with each press of the switch (⏪, ⏩).

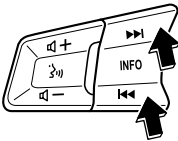

USB Audio/Bluetooth® Audio /CD

Press the seek switch (⏩) to skip forward to the beginning of the next track.

Press the seek switch (⏪) within a few seconds after playback begins to track down to the beginning of the previous track.

Press the seek switch (⏪) after a few seconds have elapsed to start playback from the beginning of the current track.

Press and hold the seek switch (⏪, ⏩) to continuously switch the tracks up or down.

Pandora®/Aha™/Stitcher™ Radio (Type B)

Press the seek switch (⏩) to skip forward to the beginning of the next track.

Press and hold the seek switch (⏩) to evaluate the playback of the current song as “Like”.

Press and hold the seek switch (⏪) to evaluate the playback of the current song as “Dislike”.

AUX/USB mode

Audio can be heard from the vehicle's speakers by connecting a commercially-available portable audio unit to the auxiliary jack.

A commercially-available, non-impedance (3.5 ϕ) stereo mini plug cable is required. Contact an Authorized Mazda Dealer for details.

In addition, audio can be played from the vehicle audio device by connecting a USB device to the USB port.

NOTE

(Type B)

The SD card slot is for the navigation system. For vehicles with the navigation system, the SD card (Mazda genuine) with stored map data is inserted into the SD card slot and used.

Type A

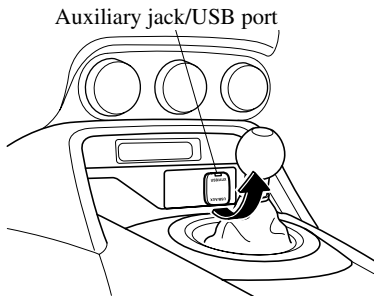

Type B

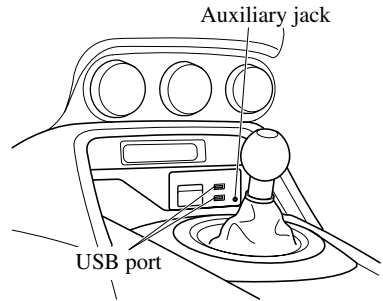

- ① How to use AUX mode (Type A) page 5-59
- ② How to use USB mode (Type A) page 5-60
- ③ How to use iPod mode (Type A) page 5-64
- ④ How to use AUX mode (Type B) page 5-67
- ⑤ How to use USB mode (Type B) page 5-67

! WARNING

Do not adjust the portable audio unit or a similar product while driving the vehicle:

Adjusting the portable audio unit or a similar product while driving the vehicle is dangerous as it could distract your attention from the vehicle operation which could lead to a serious accident. Always adjust the portable audio unit or a similar product while the vehicle is stopped.

Audio System

⚠ CAUTION

Depending on the portable audio device, noise may occur when the device is connected to the vehicle accessory socket. (If noise occurs, do not use the accessory socket.)

NOTE

- This mode may not be usable depending on the portable audio device to be connected.
- Before using the auxiliary jack/USB port, refer to the instruction manual for the portable audio device.
- Use a commercially-available, non-impedance (3.5Φ) stereo mini plug for connecting the portable audio unit to the auxiliary jack. Before using the auxiliary jack, read the manufacturer's instructions for connecting a portable audio unit to the auxiliary jack.
- To prevent discharging of the battery, do not use the auxiliary input for long periods with the engine off or idling.
- When connecting a device to the auxiliary jack or USB port, noise may occur depending on the connected device. If the device is connected to the vehicle's accessory socket, the noise can be reduced by unplugging it from the accessory socket.

▼ How to connect USB port/ Auxiliary jack

Type A

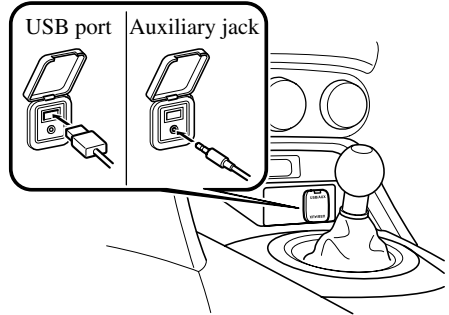

Type B

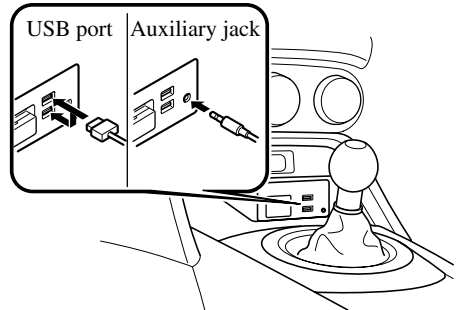

Connecting a device

1. If there is a cover on the AUX jack or USB port, remove the cover.
2. Connect the connector on the device to the USB port.

Connecting with a connector cable

1. If there is a cover on the AUX jack or USB port, remove the cover.
2. Connect the device plug/connector cable to the auxiliary jack/USB port.

WARNING

Do not allow the connection plug cord to get tangled with the parking brake or the shift lever (manual transmission)/ selector lever (automatic transmission):

Allowing the plug cord to become tangled with the parking brake or the shift lever (manual transmission)/ selector lever (automatic transmission) is dangerous as it could interfere with driving, resulting in an accident.

CAUTION

Do not place objects or apply force to the auxiliary jack/USB port with the plug connected.

NOTE

- *Insert the plug into the auxiliary jack/USB port securely.*
- *Insert or pull out the plug with the plug perpendicular to the auxiliary jack/USB port hole.*
- *Insert or remove the plug by holding its base.*

▼ How to use AUX mode (Type A)

1. Switch the ignition to ACC or ON.
2. Press the power/volume dial to turn the audio system on.
3. Press the media button (**MEDIA**) of the audio unit to change to the AUX mode.



NOTE

- *When the device is not connected to the auxiliary jack, the mode does not switch to the AUX mode.*
- *Adjust the audio volume using the portable audio device or audio unit.*
- *Audio adjustments other than audio volume can only be done using the portable audio device.*
- *If the connection plug is pulled out from the auxiliary jack while in AUX mode, noise may occur.*

Audio System

▼ How to use USB mode (Type A)

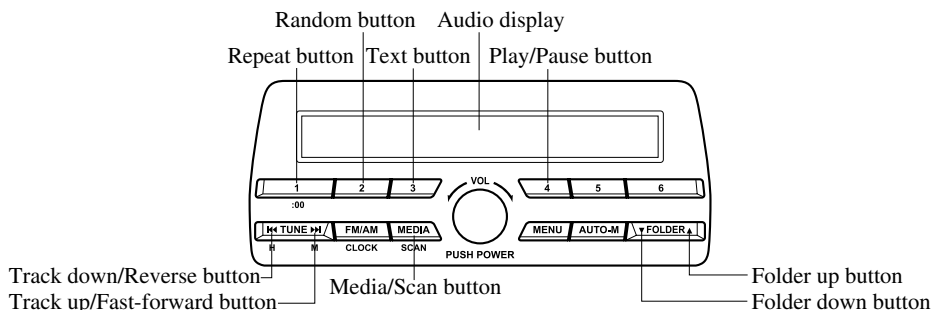

Type	Playable data
USB mode	MP3/WMA/AAC file

This unit does not support a USB 3.0 device. In addition, other devices may not be supported depending on the model or OS version.

Playback

1. Switch the ignition to ACC or ON.
2. Press the power/volume dial to turn the audio system on.
3. Press the media button (**MEDIA**) to switch to the USB mode and start playback.

NOTE

- Some devices such as smart phones may require a setting change to allow operation using a USB connection.
- When the USB device is not connected, the mode does not switch to USB mode.
- When there is no playable data in the USB device, "NO CONTENTS" is flashed.

- Playback of the USB device is in the order of the folder numbers. Folders which have no MP3/WMA/AAC files are skipped.
- Do not remove the USB device while in the USB mode. The data may be damaged.

Pause

To stop playback, press the play/pause button (4). Press the button again to resume playback.

Fast-forward/Reverse

Press and hold the fast-forward button (▶▶) to advance through a track at high speed. Press and hold the reverse button (◀◀) to reverse through a track at high speed.

Track search

Press the track up button (▶) once to skip forward to the beginning of the next track. Press the track down button (◀) within a few seconds after playback begins to track down to the beginning of the previous track.

Press the track down button (◀) after a few seconds have elapsed to start playback from the beginning of the current track.

Folder search

To change to the previous folder, press the folder down button (▼), or press the folder up button (▲) to advance to the next folder.

Music scan

This function scans the titles in a folder currently being played and plays ten seconds of each song to aid you in finding a song you want to listen to.

Press and hold the scan button (**MEDIA**) during playback to start the scan play operation (the track number will flash).

Press and hold the scan button (**MEDIA**) again to cancel scan playback.

NOTE

If the unit is left in scan, normal playback will resume where scan was selected.

Repeat playback

Track repeat

1. Press the repeat button (1) during playback to play the current track repeatedly. “TRACK RPT” is displayed (♫ is displayed next to RPT at the bottom of the display area).
2. To cancel the repeat playback, press the button again after 3 seconds.

Folder repeat

1. Press the repeat button (1) during playback, and then press the button again within 3 seconds to play the tracks in the current folder repeatedly. “FOLDER RPT” is displayed (📁 is displayed next to RPT at the bottom of the display area).
2. Press the button again to cancel the repeat playback.

Random playback

Tracks are randomly selected and played.

Folder random

1. Press the random button (2) during playback to play the tracks in the folder randomly. “FOLDER RDM” is displayed (📁 is displayed next to RDM at the bottom of the display area).
2. To cancel the random playback, press the button again after 3 seconds.

All random

1. Press the random button (2) during playback, and then press the button again within 3 seconds to play the tracks in the USB device randomly. “ALL RDM” is displayed (🔗 is displayed next to RDM at the bottom of the display area).
2. Press the button again to cancel the random playback.

Switching the display

The information displayed on the audio display changes as follows each time the text button (3) is pressed during playback.

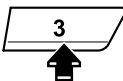
Button	Information displayed on audio display
	File number/Elapsed time
	Folder number/File number
	File name
	Folder name
	Album name
	Song name
	Artist name

Audio System

NOTE

- *The information (artist name, music name) is displayed only when the USB device information in the USB device has information which can be displayed on the screen.*
- *This unit cannot display some characters. Characters which cannot be displayed are indicated by an asterisk (*).*

Display scroll

Only 13 characters can be displayed at one time. To display the rest of the characters of a long title, press and hold the text button (3). The display scrolls the next 13 characters. Press and hold the text button (3) again after the last 13 characters have been displayed to return to the beginning of the title.

NOTE

The number of characters which can be displayed is restricted.

Error Messages

When the message “CHECK USB” is displayed, it indicates that there is some error in the USB device. Verify that the content recorded in the USB device has MP3/WMA/AAC files and re-connect correctly. If the message reappears, have the unit checked by an Authorized Mazda Dealer.

MEMO

Audio System

▼ How to use iPod mode (Type A)

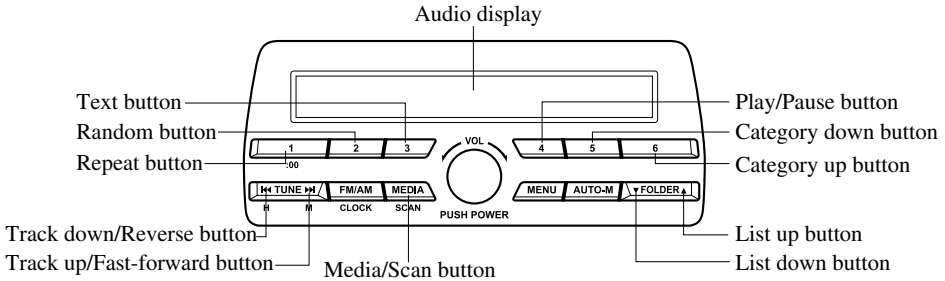

An iPod may not be compatible depending on the model or OS version. In this case, an error message is displayed.

NOTE

The iPod functions on the iPod cannot be operated while it is connected to the unit because the unit controls the iPod functions.

Playback

1. Switch the ignition to ACC or ON.
2. Press the power/volume dial to turn the audio system on.
3. Press the media button (**MEDIA**) to switch to the iPod mode and start playback.

NOTE

- When an iPod is not connected, the mode does not switch to the iPod mode.
- When there is no playable data in the iPod, "NO CONTENTS" is flashed.
- Do not remove the iPod while in the iPod mode. Otherwise, the data could be damaged.

Pause

To stop playback, press the play/pause button (4).

Press the button again to resume playback.

Fast-forward/Reverse

Press and hold the fast-forward button (▶▶) to advance through a track at high speed. Press and hold the reverse button (◀◀) to reverse through a track at high speed.

Track search

Press the track up button (▶▶) once to skip forward to the beginning of the next track. Press the track down button (◀◀) within a few seconds (depends on iPod software version) after playback begins to track down to the beginning of the previous track.

Press the track down button (◀◀) after a few seconds (depends on iPod software version) have elapsed to start playback from the beginning of the current track.

Category search

Press the category down button (5) to select the previous category and press the category up button (6) to select the next category.

NOTE

The types of categories include Playlist, Artist, Album, Song, Podcast, Genre, Composer, and Audio book.

List search

Press the list down button (▼) to select the previous list and press the list up button (▲) to select the next list.

NOTE

When the selected category is Song or Audio book, there is no list.

Music scan

This function scans the titles in a list currently being played and plays 10 seconds of each song to aid you in finding a song you want to listen to.

Press and hold the scan button (MEDIA) during playback to start the scan play operation (the track number will flash). Press and hold the scan button (MEDIA) again to cancel scan playback.

NOTE

If the unit is left in scan, normal playback will resume where scan was selected.

Repeat playback

1. Press the repeat button (1) during playback to play the current track repeatedly. "TRACK RPT" is displayed (♫ is displayed next to RPT at the bottom of the display area).
2. Press the button again to cancel the repeat playback.

Random playback

Tracks are randomly selected and played.

Song random

1. Press the random button (2) during playback to play the tracks in the list randomly. "SONG RDM" is displayed (🎲 is displayed next to RDM at the bottom of the display area).
2. To cancel the random playback, press the button again after 3 seconds.

Album random

1. Press the random button (2) during playback, and then press the button again within 3 seconds to play the tracks in the iPod randomly. "ALBUM RDM" is displayed (🎲 is displayed next to RDM at the bottom of the display area).
2. Press the button again to cancel the random playback.

NOTE

The track number being played randomly is in the order of the iPod shuffle table.

Switching the display

The information displayed on the audio display changes as follows each time the text button (3) is pressed during playback.

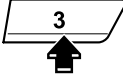
Button	Information displayed on audio display
	File number/Elapsed time
	File number
	Category name
	Artist name
	Album name
	Song name

Audio System

NOTE

- *The information (artist name, music name) is displayed only when the iPod has information which can be displayed.*
- *This unit cannot display some characters. Characters which cannot be displayed are indicated by an asterisk (*).*

Display scroll

13 characters can be displayed at one time. To display the rest of the characters of a long title, press and hold the text button (3). The display scrolls the next 13 characters. Press and hold the text button (3) again after the last 13 characters have been displayed to return to the beginning of the title.

NOTE

The number of characters which can be displayed is restricted.

Error Messages

If the message “CHECK iPod” is displayed, it indicates that there is a malfunction in the iPod. Verify that the content recorded in the iPod has playable files and connect correctly. If the message reappears, have the unit checked by an Authorized Mazda Dealer.



▼ Error Indications (Type A)

If you see an error indication on the display, find the cause in the chart. If you cannot clear the error indication, take the vehicle to an Authorized Mazda Dealer.

Indication	Cause	Solution
CHECK USB	USB device malfunction	Verify that the content recorded in the USB device has MP3/WMA/AAC files and re-connect correctly. If the error indication continues to display, consult an Authorized Mazda Dealer.
CHECK iPod	iPod malfunction	Verify that the content recorded in the iPod has playable files and re-connect correctly. If the error indication continues to display, consult an Authorized Mazda Dealer.

▼ How to use AUX mode (Type B)

1. Select the  icon on the home screen to display the Entertainment screen.
2. Select **AUX** to switch to the AUX mode. The following icons are displayed in the lower part of the center display.

Icon	Function
	Displays the Entertainment menu. Use to switch to a different audio source.
	Displays sound settings to adjust audio quality level. Refer to Volume/Display/Sound Controls on page 5-40.

NOTE

- *If a device is not connected to the auxiliary jack, the mode does not switch to the AUX mode.*
- *Adjust the audio volume using the portable audio device, commander switch, or audio control switch.*
- *Audio adjustments can also be made using the portable audio device's volume setting.*
- *If the connection plug is pulled out from the auxiliary jack while in AUX mode, noise may occur.*

▼ How to use USB mode (Type B)

Type	Playable data
USB mode	MP3/WMA/AAC/OGG file











This unit does not support a USB 3.0 device. In addition, other devices may not be supported depending on the model or OS version.

USB devices formatted to FAT32 are supported (USB devices formatted to other formats such as NTFS are not supported).

Audio System

Playback

1. Select the  icon on the home screen to display the Entertainment screen.
2. Select **USB 1** or **USB 2** to switch the USB mode. The following icons are displayed in the lower part of the center display.

Icon	Function
	Displays the Entertainment menu. Use to switch to a different audio source.
	Category list is displayed.
	Current track list is displayed. Select a desired track to play it.
	Plays the current track repeatedly. Select it again to play the tracks in the current track list repeatedly. When selected again, the function is canceled.
	Tracks in the current track list are played randomly. Select it again to cancel.
	Starts playing a track similar to the current track using Gracenote's More Like This™. Select the desired song from the category list to cancel More Like This™.
	If selected within a few seconds from the beginning of a song which has started to play, the previous song is selected. If more than a few seconds have elapsed, the song currently being played is replayed from the beginning. Long-press to fast reverse. It stops when you remove your hand from the icon or the commander knob.
	Track is played. When selected again, playback is temporarily stopped.
	Advances to the beginning of the next song. Long-press to fast forward.
	Displays sound settings to adjust audio quality level. Refer to Volume/Display/Sound Controls on page 5-40.

NOTE

- If a file name in the USB memory is too long, it could cause operation problems such as not being able to playback the song.
(Recommended: Within 80 characters)
- To move to the desired location on the track, move the slider indicating the playback time.
- The appearance of the repeat and shuffle icons changes depending on the type of operation in which the function is used.

Category list

Select the  icon to display the following category list.
Select a desired category and item.

Category	Function
Playlist* ¹	Displays playlists on the device.
Artist	Displays the artist name list. All the tracks or tracks for each album of the selected artist can be played.
Album	Displays the album name list.
Song	All the tracks in the device are displayed.
Genre	Displays the genre list. All the tracks or tracks per album or artist in the selected genre can be played.
Audiobook* ²	Displays the audiobook list. Chapters can be selected and played.
Podcast* ²	Displays the podcast list. Episode can be selected and played.
Folder* ³	Displays the folder/file list.

*1 Playlist folders of Apple devices are not supported.

*2 Apple device only

*3 USB-Sticks and USB-Android™ device only

Audio System

Example of use (to play all tracks in USB device)

(Method 1)

1. Select  to display the category list.
2. Select **Song**.
All the tracks in the USB device are displayed.
3. Select a desired track.
The selected track is played. All the tracks in the USB device can be played by continuing playback.

NOTE

Only the tracks in the desired category selected in Step 2 are played.

(Method 2)*1

1. Select  to display the category list.
2. Select **Folder**.
All the folders in the USB device are displayed.
3. Select **All Songs**.
All the tracks in the USB device are displayed.
4. Select a desired track.
The selected track is played. All the tracks in the USB device can be played by continuing playback.

*1 Can be operated using an Android™ device or USB flash memory.

NOTE

Only the tracks in the desired folder selected in Step 3 are played.

▼ Gracenote Database (Type B)

When a USB device is connected to this unit and the audio is played, the album name, artist name, genre and title information are automatically displayed if there is a match in the vehicle's database compilation to the music being played. The information stored in this device uses database information in the Gracenote music recognition service.



*For information related to the most recent Gracenote database which can be used and how to install it, go to the Mazda Hands Free Website:
<http://www.mazdahandsfree.com>*

Introduction

Music recognition technology and related data are provided by Gracenote®. Gracenote is the industry standard in music recognition technology and related content delivery. For more information visit www.gracenote.com.

CD and music-related data from Gracenote, Inc., copyright © 2000 to present Gracenote. Gracenote Software, copyright © 2000 to present Gracenote. One or more patents owned by Gracenote apply to this product and service. See the Gracenote website for a non-exhaustive list of applicable Gracenote patents. Gracenote, CDDDB, MusicID, MediaVOCS, the Gracenote logo and logotype, and the “Powered by Gracenote” logo are either registered trademarks or trademarks of Gracenote in the United States and/or other countries.



Gracenote® End User License Agreement

This application or device contains software from Gracenote, Inc. of Emeryville, California (“Gracenote”). The software from Gracenote (the “Gracenote Software”) enables this application to perform disc and/or file identification and obtain music-related information, including name, artist, track, and title information (“Gracenote Data”) from online servers or embedded databases (collectively, “Gracenote Servers”) and to perform other functions. You may use Gracenote Data only by means of the intended End-User functions of this application or device.

You agree that you will use Gracenote Data, the Gracenote Software, and Gracenote Servers for your own personal non-commercial use only. You agree not to assign, copy, transfer or transmit the Gracenote Software or any Gracenote Data to any third party. **YOU AGREE NOT TO USE OR EXPLOIT GRACENOTE DATA, THE GRACENOTE SOFTWARE, OR GRACENOTE SERVERS, EXCEPT AS EXPRESSLY PERMITTED HEREIN.**

Audio System

You agree that your non-exclusive license to use the Gracenote Data, the Gracenote Software, and Gracenote Servers will terminate if you violate these restrictions. If your license terminates, you agree to cease any and all use of the Gracenote Data, the Gracenote Software, and Gracenote Servers. Gracenote reserves all rights in Gracenote Data, the Gracenote Software, and the Gracenote Servers, including all ownership rights. Under no circumstances will Gracenote become liable for any payment to you for any information that you provide. You agree that Gracenote, Inc. may enforce its rights under this Agreement against you directly in its own name.

The Gracenote service uses a unique identifier to track queries for statistical purposes. The purpose of a randomly assigned numeric identifier is to allow the Gracenote service to count queries without knowing anything about who you are. For more information, see the web page for the Gracenote Privacy Policy for the Gracenote service.

The Gracenote Software and each item of Gracenote Data are licensed to you “AS IS.” Gracenote makes no representations or warranties, express or implied, regarding the accuracy of any Gracenote Data from in the Gracenote Servers. Gracenote reserves the right to delete data from the Gracenote Servers or to change data categories for any cause that Gracenote deems sufficient. No warranty is made that the Gracenote Software or Gracenote Servers are error-free or that functioning of Gracenote Software or Gracenote Servers will be uninterrupted. Gracenote is not obligated to provide you with new enhanced or additional data types or categories that Gracenote may provide in the future and is free to discontinue its services at any time.

GRACENOTE DISCLAIMS ALL WARRANTIES EXPRESS OR IMPLIED, INCLUDING, BUT NOT LIMITED TO, IMPLIED WARRANTIES OF MERCHANTABILITY, FITNESS FOR A PARTICULAR PURPOSE, TITLE, AND NON-INFRINGEMENT. GRACENOTE DOES NOT WARRANT THE RESULTS THAT WILL BE OBTAINED BY YOUR USE OF THE GRACENOTE SOFTWARE OR ANY GRACENOTE SERVER. IN NO CASE WILL GRACENOTE BE LIABLE FOR ANY CONSEQUENTIAL OR INCIDENTAL DAMAGES OR FOR ANY LOST PROFITS OR LOST REVENUES.

© 2000 to present. Gracenote, Inc.

Updating the database

The Gracenote media database can be updated using USB device.

1. Connect a USB device containing the software for updating Gracenote.
2. Select the  icon on the home screen to display the Settings screen.
3. Select the **System** tab and select **Music Database Update**.
4. Select **Search**. The list of the update package stored in the USB device and the version are displayed.
5. Select the package to use the update.
6. Select **Install**.

NOTE

Gracenote can be downloaded from the Mazda Hands-free Website.

Bluetooth®

Bluetooth® Hands-Free outline

When a Bluetooth® device (mobile phone) is connected to the vehicle's Bluetooth® unit via radio wave transmission, a call can be made or received by pressing the talk button, pick-up button, or hang-up button on the audio remote control switch, or by operating the center display. For example, even if a device (mobile phone) is in your coat pocket, a call can be made without taking the device (mobile phone) out and operating it directly.

Bluetooth® audio outline

When a portable audio unit equipped with the Bluetooth® communication function is paired to the vehicle, you can listen to music stored on the paired portable audio device from the vehicle's speakers. It is not necessary to connect the portable audio device to the vehicle's external input terminal. After programming, operate the vehicle audio control panel to play/stop the audio.

NOTE

- *For your safety, a device can be paired only when the vehicle is parked. If the vehicle starts to move, the pairing procedure will end. Park the vehicle in a safe place before pairing.*
- *The communication range of a Bluetooth® equipped device is about 10 meters (32 ft) or less.*
- *Basic audio operation is available using voice commands even if Bluetooth® is not connected.*
- *For safety reasons, operation of the center display is disabled while the vehicle is being driven. However, items not displayed in gray can be operated using the commander switch while the vehicle is being driven.*

⚠ CAUTION

Some Bluetooth® mobile devices are not compatible with the vehicle. Consult an Authorized Mazda Dealer, Mazda's call center or Web support center for information regarding Bluetooth® mobile device compatibility:

- U.S.A.
Phone: 800-430-0153
Web: www.mazdausa.com/mazdaconnect
- Canada
Phone: 800-430-0153
Web: www.mazdahandsfree.ca
- Mexico
Center of Attention to Client (CAC)
Phone: 01-800-01-MAZDA
Web: www.mazdamexico.com.mx

Applicable Bluetooth® specification (Recommended)

Type A: Ver. 2.0

Type B: Ver. 1.1/1.2/2.0 + EDR/2.1 + EDR/3.0 (conformity)

▼ Component Parts

Audio unit

Type A

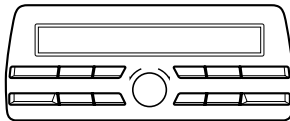

Type B

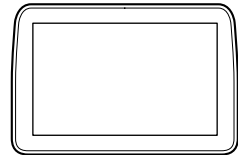

Talk button, Pick-up button and Hang-up button

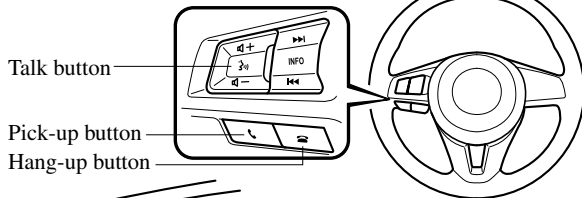

Microphone

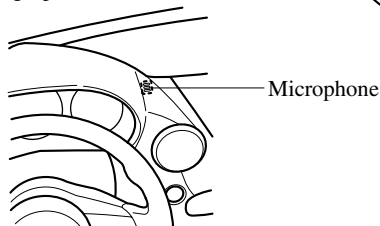

Bluetooth®

Microphone (hands-free)

The microphone is used for speaking voice commands or when making a Hands-free call.

Talk button, Pick-Up button and Hang-Up button (hands-free)

The basic functions of Bluetooth® Hands-Free can be used for such things as making calls or hanging up using the talk, pick-up and hang-up buttons on the steering wheel.

Commander switch (Type B)

The commander switch is used for volume adjustment and display operation. Tilt or turn the commander knob to move the cursor. Press the commander knob to select the icon.

Volume adjustment

The power/volume dial of the audio unit*¹ or the volume dial of the commander switch*² is used to adjust the volume. Turn the dial to the right to increase volume, to the left to decrease it.

The volume can also be adjusted using the volume button on the steering wheel.

*1 Type A

*2 Type B

NOTE

If the volume is lower compared to other audio modes, increase the volume from the device side.

(Type B)

Conversation volume and the volume of the voice guidance and ringtone can each be set in advance.

1. Select the  icon on the home screen to display the Communication screen.
2. Select **Settings**.
3. Adjust the **Phone Volume** and the **VR and Ringtone** using the slider.

▼ Bluetooth® Preparation (Type A)

Bluetooth® Hands-Free Preparation

Pairing code setting

The 4-digit pairing code setting for registration of your cell phone (pairing) can be set beforehand.

NOTE

The initial setting value is "0000".

1. Press the pick-up button or talk button with a short press.
2. **Say:** [Beep] "Setup"
3. **Prompt:** "Select one of the following: Pairing options, confirmation prompts, language, passcode, select phone or select music player."
4. **Say:** [Beep] "Pairing options"
5. **Prompt:** "Select one of the following: Pair, Edit, Delete, List, or Set Pairing Code."
6. **Say:** [Beep] "Set pairing code"
7. **Prompt:** "Your current pairing code is XXXX. Do you want to change it to a different pairing code?"
8. **Say:** [Beep] "Yes"
9. **Prompt:** "Please say a 4-digit pairing code."
10. **Say:** [Beep] "YYYY"
11. **Prompt:** "YYYY is this correct?"
12. **Say:** [Beep] "Yes" or "No"
13. If "Yes", go to Step 14. If "No", the procedure returns to Step 9.
14. **Prompt:** "Your new pairing code is YYYY. Use this pairing code when pairing devices to the Hands free system. Do you want to pair a device now?"
15. **Say:** [Beep] "Yes" or "No"
16. If "Yes", the system switches to the device registration mode. If "No", the system returns to standby status.

Device pairing

To use Bluetooth® Hands-Free, the device equipped with Bluetooth® has to be paired to the Bluetooth® unit using the following procedure.

A maximum of seven devices including hands-free mobile phones and Bluetooth® audio devices can be paired to one vehicle.

NOTE

If a Bluetooth® device has already been paired to the vehicle as a Bluetooth® audio device, it does not need to be paired again when using the device as a hands-free mobile phone. Conversely, it does not need to be paired again as a Bluetooth® audio device if it has already been paired as a hands-free mobile phone.

1. Activate the Bluetooth® application of the device.

NOTE

For the operation of the device, refer to its instruction manual.

2. Press the pick-up button or talk button with a short press.
3. **Say:** [Beep] "Setup"
4. **Prompt:** "Select one of the following: Pairing options, confirmation prompts, language, passcode, select phone or select music player."
5. **Say:** [Beep] "Pairing options"
6. **Prompt:** "Select one of the following: Pair, Edit, Delete, List, or Set Pairing Code."
7. **Say:** [Beep] "Pair"
8. **Prompt:** "Start the pairing process on your Bluetooth® device. Your pairing code is 0000 (XXXX). Input this on your Bluetooth® device when prompted on the device. See device manual for instructions."

Bluetooth®

9. Using the device, perform a search for the Bluetooth® device (Peripheral device).

NOTE

For the operation of the device, refer to its instruction manual.

10. Select “Mazda” from the device list searched by the device.
11. Input the 4-digit pairing code to the device.
12. **Prompt:** “Please say the name of the device after the beep.”
13. **Say:** [Beep] “XXXX - - -” (Say a “device tag”, an arbitrary name for the device.) Example: “Stan's device.”

NOTE



Say a paired “device tag” within 10 seconds.

If more than two devices are to be paired, they cannot be paired with the same or similar “device tag”.

14. **Prompt:** “XXXXXX - - -” (Ex. “Stan's device”) (Device tag). Is this correct?”
15. **Say:** [Beep] “Yes”
16. **Prompt:** “Pairing complete”

After a device is registered, the system automatically identifies the device. By activating Bluetooth® Hands-Free again, or by activating Bluetooth® Hands-Free first after switching the ignition from OFF to ACC, the system reads out a voice guidance, “XXXXXX - - -” (Ex. “Stan's device”) (Device tag) is connected”.

NOTE

- *When the pairing is completed, the  symbol is displayed.*
- *Some Bluetooth® audio devices need a certain amount of time before the  symbol is displayed.*
- *Device registration can also be done by operating the audio unit.*
- *Depending on the device, the registration status may be lost after a certain period of time. If this occurs, repeat the entire process from Step 1.*

Registered device read-out

Bluetooth® Hands-Free can read-out the devices registered to its system.

NOTE

Do this function only when parked. It is too distracting to attempt while driving and you may make too many errors to be effective.

1. Press the pick-up button or talk button with a short press.
2. **Say:** [Beep] “Setup”
3. **Prompt:** “Select one of the following: Pairing options, confirmation prompts, language, passcode, select phone or select music player.”
4. **Say:** [Beep] “Pairing options”
5. **Prompt:** “Select one of the following: Pair, Edit, Delete, List, or Set Pairing Code”
6. **Say:** [Beep] “List”

7. **Prompt:** “XXXXX..., XXXXX..., XXXXX... (Ex. Device A, device B, device C)” (The voice guidance reads out the device tags registered to the hands-free system.)

Press the talk button with a short press during the read-out at the desired device, and then say one of the following voice commands to execute it.

- “Select phone”: Selects device (Mobile phone) when the talk button is short-pressed.
- “Select music player”: Selects device (Music player) when the talk button is short-pressed.
- “Edit”: Edits device when the talk button is short-pressed.
- “Continue”: Continues the list readout.
- “Delete”: Deletes the registered device when the talk button is short-pressed.
- “Previous”: Returns to the previous device in read-out when the talk button is short-pressed.

8. **Prompt:** “End of list, would you like to start from the beginning?”
9. **Say:** [Beep] “No”
10. **Prompt:** “Returning to main menu.”

Device selection

If several devices have been paired, the Bluetooth® unit links the device last paired. If you would like to link a different paired device, it is necessary to change the link. The order of device priority after the link has been changed is maintained even when the ignition is switched off.

(Hands-free phone)

1. Press the pick-up button or talk button with a short press.
2. **Say:** [Beep] “Setup”
3. **Prompt:** “Select one of the following: Pairing options, confirmation prompts, language, passcode, select phone or select music player.”
4. **Say:** [Beep] “Select phone”
5. **Prompt:** “Please say the name of the device you would like to select. Available devices are XXXXX... (Ex. device A), XXXXX... (Ex. device B), XXXXX... (Ex. device C). Which device please?”
6. **Say:** [Beep] “XXXXX... (Ex. Device B)”
7. **Prompt:** “XXXXX... (Ex. Device B). Is this correct?”
8. **Say:** [Beep] “Yes” or “No”
9. If “Yes”, go to Step 10. If “No”, the procedure returns to Step 5.
10. **Prompt:** “XXXXX... (Ex. Device B) selected.”





(Music player)

1. Press the pick-up button or talk button with a short press.
2. **Say:** [Beep] “Setup”
3. **Prompt:** “Select one of the following: Pairing options, confirmation prompts, language, passcode, select phone or select music player.”
4. **Say:** [Beep] “Select music player”
5. **Prompt:** “Please say the name of the device you would like to select. Available devices are XXXXX... (Ex. device A), XXXXX... (Ex. device B), XXXXX... (Ex. device C). Which device please?”
6. **Say:** [Beep] “XXXXX... (Ex. Device B)”
7. **Prompt:** “XXXXX... (Ex. Device B). Is this correct?”

Bluetooth®

8. **Say:** [Beep] “Yes” or “No”
9. If “Yes”, go to Step 10. If “No”, the procedure returns to Step 5.
10. **Prompt:** “XXXXX... (Ex. Device B) selected.”

NOTE

- When the selected device connection is completed, the  or  symbol is displayed.
- Some Bluetooth® audio devices need a certain amount of time before the  or  symbol is displayed.
- Device (Music player) selection can also be done by operating the panel button.

Deleting a device

Registered devices (Mobile phone) can be deleted individually or collectively.

NOTE

Do this function only when parked. It is too distracting to attempt while driving and you may make too many errors to be effective.

1. Press the pick-up button or talk button with a short press.
2. **Say:** [Beep] “Setup”
3. **Prompt:** “Select one of the following: Pairing options, confirmation prompts, language, passcode, select phone or select music player.”
4. **Say:** [Beep] “Pairing options”
5. **Prompt:** “Select one of the following: Pair, Edit, Delete, List, or Set Pairing Code.”

NOTE

A registered device (Mobile phone) can be deleted using the registration list.

6. **Say:** [Beep] “Delete”

7. **Prompt:** “Please say the name of the device you would like to delete. Available devices are XXXXX... (Ex. device A), XXXXX... (Ex. device B), XXXXX... (Ex. device C), or all. Which device please?”
8. **Say:** [Beep] “X” (Say the number of the device to be deleted.)

NOTE

Say “All” to delete all devices (Mobile phone).

9. **Prompt:** “Deleting XXXXX... (Ex. device B...) (Registered device tag). Is this correct?”
10. **Say:** [Beep] “Yes”
11. **Prompt:** “Deleted”

Registered device editing

1. Press the pick-up button or talk button with a short press.
2. **Say:** [Beep] “Setup”
3. **Prompt:** “Select one of the following: Pairing options, confirmation prompts, language, passcode, select phone or select music player.”
4. **Say:** [Beep] “Pairing options”
5. **Prompt:** “Select one of the following: Pair, Edit, Delete, List, or Set Pairing Code.”
6. **Say:** [Beep] “Edit”
7. **Prompt:** “Please say the name of the device you would like to edit. Available devices are XXXXX... (Ex. device A), XXXXX... (Ex. device B), XXXXX... (Ex. device C). Which device please?”
8. **Say:** [Beep] “X” (Say the number of the device to be edited.)
9. **Prompt:** “New name please?”
10. **Say:** [Beep] “XXXXX... (Ex. Device C)” (Speak a “device tag” an arbitrary name for the device.)
11. **Prompt:** “XXXXX... (Ex. device C) (Device tag), is this correct?”

12. **Say:** [Beep] “Yes”
 13. **Prompt:** “New name saved.”

Bluetooth® Audio Preparation

Bluetooth® audio device set-up

Bluetooth® audio pairing, changes, deletions, and display of paired device information can be performed.

1. The mode changes as follows each time the menu button (**MENU**) is pressed. Select “BT SETUP”.

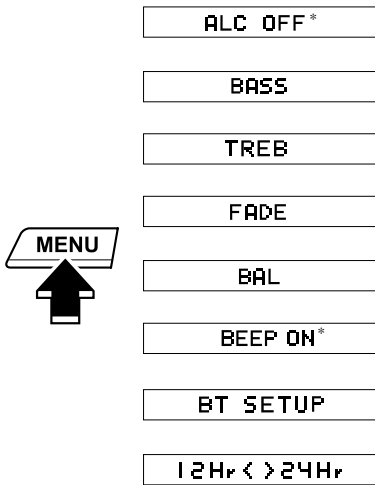

* Depending on the mode selected, the indication changes.

2. Turn the audio control dial and select a desired mode.

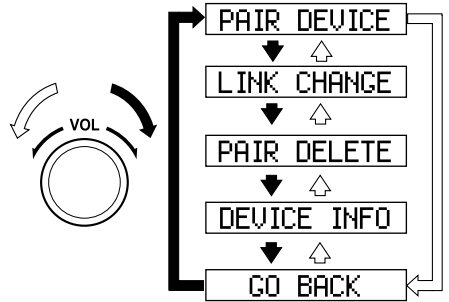

Display	Mode	Function
PAIR DEVICE	Pairing mode	Bluetooth® audio device pairing
LINK CHANGE	Link change mode	Changing link to Bluetooth® audio device
PAIR DELETE	Pairing deletion mode	Deleting link to Bluetooth® audio device
DEVICE INFO	Device information display mode	Displaying vehicle's Bluetooth® unit information

3. Press the audio control dial to determine the mode.

Bluetooth®

Bluetooth® audio device pairing

Any Bluetooth® audio device must be paired to the vehicle's Bluetooth® unit before it can be listened to over the vehicle's speakers.

A maximum of seven devices including Bluetooth® audio devices and hands-free mobile phones can be paired to one vehicle.

NOTE

- *If a Bluetooth® device has already been paired to the vehicle as a hands-free mobile phone, it does not need to be paired again when using the device as a Bluetooth® audio device. Conversely, it does not need to be paired again as a hands-free mobile phone if it has already been paired as a Bluetooth® audio device.*
- *Device registration can also be done using voice recognition.*

Concerning the operation of a Bluetooth® audio device itself, refer to its instruction manual.

Some Bluetooth® audio devices have PIN codes (four digits). Refer to the audio device's instruction manual because the pairing procedure differs depending on whether it has a PIN code or not.

Pairing a Bluetooth® audio device which has a four-digit PIN code

1. Using the audio control dial, select the pairing mode "PAIR DEVICE" in the "BT SETUP" mode. (Refer to "Bluetooth® audio device set-up" for details.)
2. Press the audio control dial to determine the mode. After "ENTER PIN" is displayed on the audio display for three seconds, "PIN 0000" is displayed and the PIN code can be input.

3. Input the PIN code of your Bluetooth® audio device by pressing channel preset buttons 1 to 4 while "PIN 0000" is displayed.

Press channel preset button 1 to input the first digit, 2 for the second, 3 for the third, and 4 for the fourth. For example, if the PIN code were "4213" press channel preset button 1 four times (1, 2, 3, 4), button 2 twice (1, 2), button 3 once (1), and button 4 three times (1, 2, 3). If the "PIN 0000" display disappears before finishing the PIN code input, repeat the procedure from Step 1.

NOTE

Some devices accept only a particular pairing code (Usually, "0000" or "1234").

If pairing cannot be completed, refer to the owner's manual of your mobile device, and try those numbers if necessary.

4. Press the audio control dial while the input PIN code is displayed. "PAIRING" flashes on the audio display.
5. Operate the Bluetooth® audio device and set it to the pairing mode while "PAIRING" is flashing.
6. When the pairing is completed, 🎵 and "PAIR SUCCESS" are displayed after about 10-30 seconds, after which "PAIR SUCCESS" continues to be displayed for three seconds, and then the unit returns to the normal display.

NOTE

- Some Bluetooth® audio devices need a certain amount of time before the  symbol is displayed.
- If the pairing failed, “Err” flashes for three seconds.
- Pairing cannot be performed while the vehicle is moving. If you attempt to perform pairing while the vehicle is moving, “PAIR DISABLE” is displayed.
- If seven Bluetooth® audio devices have already been paired to the vehicle, pairing cannot be performed and “MEMORY FULL” is displayed. Delete one paired device to pair another one.

Pairing a Bluetooth® audio device which does not have a four-digit PIN code

1. Using the audio control dial, select the pairing mode “PAIR DEVICE” in the “BT SETUP” mode. (Refer to “Bluetooth® audio set up” for details.)
2. Press the audio control dial to determine the mode. After “ENTER PIN” is displayed on the audio display for three seconds, “PIN 0000” is displayed and the PIN code can be input.
3. Press the audio control dial while “PIN 0000” is displayed. “PAIRING” flashes on the audio display.
4. Operate the Bluetooth® audio device and set it to the pairing mode while “PAIRING” is flashing.
5. As the Bluetooth® audio device requires a PIN code, input “0000”.
6. When the pairing is completed,  and “PAIR SUCCESS” are displayed after about 10-30 seconds, after which “PAIR SUCCESS” continues to be displayed for three seconds, and then the unit returns to the normal display.

NOTE

- If pairing cannot be completed, try “1234” instead. Refer to the owner's manual of your mobile device for the right PIN code.
- Some Bluetooth® audio devices need a certain amount of time before the  symbol is displayed.
- If the pairing failed, “Err” flashes for three seconds.
- Pairing cannot be performed while the vehicle is moving. If you attempt to perform pairing while the vehicle is moving, “PAIR DISABLE” is displayed.
- If seven Bluetooth® audio devices have already been paired to the vehicle, pairing cannot be performed and “MEMORY FULL” is displayed. Delete one paired device to pair another one.

Device selection

If several devices have been paired, the Bluetooth® unit links the device last paired. If you would like to link a different paired device, it is necessary to change the link. The order of device priority after the link has been changed is maintained even when the ignition is switched off.

1. Using the audio control dial, select the link change mode “LINK CHANGE” in the “BT SETUP” mode. (Refer to “Bluetooth® audio device set-up” for details.)
2. Press the audio control dial to determine the mode.
3. The name of the currently linked Bluetooth® audio device is displayed. If no Bluetooth® audio device is currently linked, the name of the first device among the paired devices is displayed.

- Turn the audio control dial to select the name of the device you would like to link.

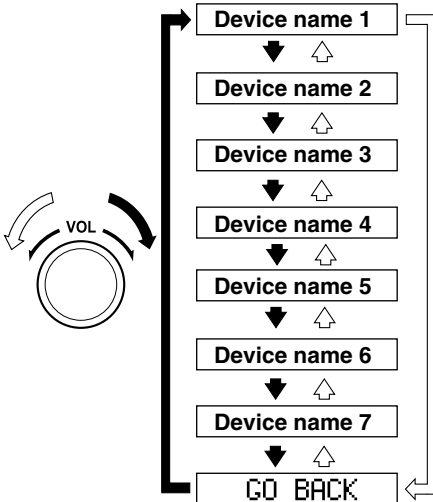

- Press the audio control dial to select the device you would like to link. The 🎵 symbol disappears, and “PAIRING” flashes in the audio display.

NOTE

When “GO BACK” is selected and the audio control dial is pressed, the display returns to “LINK CHANGE”.

- If the link to the desired device is successful, the 🎵 symbol is displayed again, together with “LINK CHANGED”. “LINK CHANGED” is displayed for three seconds, then it returns to the normal display.

NOTE

- Some Bluetooth® audio devices need a certain amount of time before the 🎵 symbol is displayed.
- If a hands-free type mobile phone has been the most recently paired device, the Bluetooth® unit links this device. If you would like to use a Bluetooth® audio type device which has been previously paired to the Bluetooth® unit, the link must be changed to this device.
- If an error occurs while trying to link a device, “Err” flashes in the audio display for three seconds, and the display returns to “LINK CHANGE”. If this occurs, check the pairing status of the Bluetooth® audio device and the location of the device in the vehicle (not in the trunk or a metal-type box), and then try the link operation again.
- Device selection can also be done using voice recognition.

How to confirm the device currently linked

Switch to the link-change mode. (Refer to “Changing the link to a Bluetooth® audio device”)

The device name displayed first is the device which is currently linked.

Deleting a device

- Using the audio control dial, select the pairing delete mode “PAIR DELETE” in the “BT SETUP” mode. (Refer to “Bluetooth® audio device set-up” for details.)
- Press the audio control dial to determine the mode.
- The name of the first device among the paired devices is displayed.

4. Rotate the audio control dial and select the name of the paired device you would like to delete.

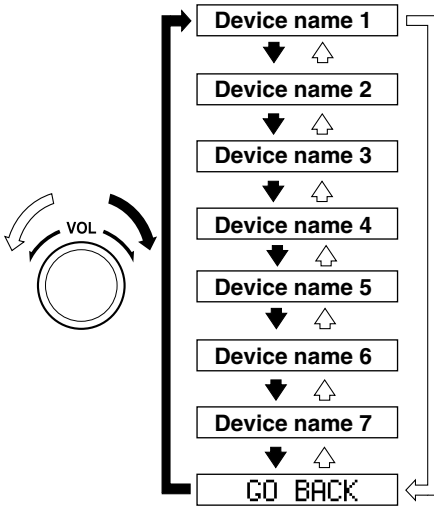

NOTE

Only the names of paired devices can be displayed. If only one device is paired, only the name for this device is displayed.

5. If a selection other than “GO BACK” is made and the audio control dial is pressed, “SURE ? NO” is displayed.
6. Rotate the audio control dial clockwise and switch the display to “SURE ? YES”.

NOTE

The display changes as follows depending on whether the audio control dial is rotated clockwise or counterclockwise.
 -Clockwise: “SURE ? YES” displayed
 -Counterclockwise: “SURE ? NO” displayed

7. Press the audio control dial to delete the selected device.

NOTE

Select “GO BACK” and press the audio control dial to return to the “PAIR DELETE” display.

8. “PAIR DELETED” is displayed for three seconds after the deletion is completed, and then it returns to the normal display.

NOTE

If an error occurs while trying to delete the paired device, “Err” flashes in the display for three seconds and the display returns to “LINK DELETE”.

Bluetooth® audio device information display

1. Using the audio control dial, select the pair device information display mode “DEVICE INFO” in the “BT SETUP” mode. (Refer to “Bluetooth® audio device set-up” for details.)
2. Press the audio control dial to determine the mode.
3. The name of the Bluetooth® unit device is displayed.
4. Rotate the audio control dial to select the information for the Bluetooth® unit which you would like to view.

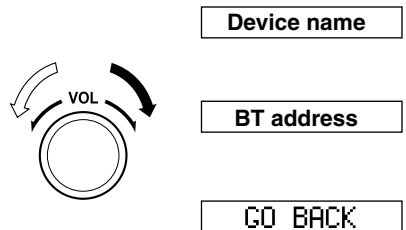

NOTE

When “GO BACK” is selected and the audio control dial is pressed, the display returns to “DEVICE INFO”.

▼ Available Language (Type A)

The available languages are English, Spanish, and Canadian French. If the language setting is changed, all of the voice guidance and voice input commands are done in the selected language.

NOTE

- If the language setting is changed, device registration is maintained.
- Phonebook records are not cleared, but each language has a separate phonebook. Therefore, entries created in one language will need to be re-entered in the phonebook of the new language.
- Do these steps before you start driving. These less used functions are too distracting to undertake while driving until you are fully familiar with the system.

(Method 1)

1. Press the pick-up button or talk button with a short press.
2. **Say:** [Beep] “Setup”
3. **Prompt:** “Select one of the following: Pairing options, confirmation prompts, language, passcode, select phone or select music player.”
4. **Say:** [Beep] “Language”
5. **Prompt:** “Select a language: English, French, or Spanish.”
6. **Say:** [Beep] “French” (Speak the desired language: “English”, “French” or “Spanish”)

NOTE

Other language settings can also be made while in the current setting by saying the name of the language in the native pronunciation.

7. **Prompt:** “French (Desired language) selected. Is this correct?”
8. **Say:** [Beep] “Yes”
9. **Prompt:** “French (Desired language) selected” (Spoken in the newly selected language).

(Method 2)

1. Press the pick-up button or talk button with a short press.
2. **Say:** [Beep] “French” (Say the desired language: “English”, “French” or “Spanish”). (Change the desired language by saying the language name.)

NOTE

Other language settings can also be made while in the current setting by saying the name of the language in the native pronunciation.

3. **Prompt:** “Would you like to change the language to French (Desired language)?”
4. **Say:** [Beep] “Yes”
5. **Prompt:** “Please wait. Switching to French phonebook. French selected” (Spoken in the newly selected language).

▼ Voice Recognition (Type A)

In this section, the basic operation of the voice recognition is explained.

Activating Voice Recognition

To Activate the Main Menu: Press the pick-up button or talk button with a short press.

Ending Voice Recognition

Use one of the following methods:

- Press and hold the talk-button.
- Press the hang-up button.

Skipping Voice Guidance (for faster operation)

Press and release the talk-button.

NOTE

- *The Bluetooth® Hands-Free system is operable several seconds after the ignition is switched to ACC or ON (requires less than 15 seconds).*
- *When operating the audio unit or the A/C while using Bluetooth® Hands-Free, the beep sounds or voice guidance (audio unit)/cannot be heard.*

Tutorial

The tutorial explains how to use Bluetooth® Hands-Free.

To activate the tutorial, do the following:

1. Press the pick-up button or talk button with a short press.
2. **Say:** [Beep] “Tutorial”
3. Follow the prompts to receive the appropriate voice guidance instructions.

Commands useable anytime during voice recognition

“Help” or “Go Back” are commands which can be used at anytime during voice recognition.

Help function use

The help function informs the user of all the available voice commands under the current conditions.

1. **Say:** [Beep] “Help”
2. Follow the prompts to receive the appropriate voice guidance instructions.

Returning to previous operation

This command is for returning to the previous operation while in the voice recognition mode.

Say: [Beep] “Go Back”

To prevent a deterioration in the voice recognition rate and voice quality, the following points should be observed:

- **The voice recognition cannot be performed while voice guidance or the beep sound is operating. Wait until the voice guidance or the beep sound is finished before saying your commands.**
- Dialects or different wording other than hands-free prompts cannot be recognized by voice recognition. Speak in the wording specified by the voice commands.
- It is not necessary to face the microphone or approach it. Speak the voice commands while maintaining a safe driving position.
- Do not speak too slow or too loud.
- Speak clearly, without pausing between words or numbers.

Bluetooth®

- Close the windows and/or the convertible top to reduce loud noises from outside the vehicle, or turn down the airflow of the air-conditioning system while Bluetooth® Hands-Free is being used.
- Make sure the vents are not directing air up towards the microphone.

NOTE

If the voice recognition performance is not satisfactory.

Refer to Voice Recognition Learning Function (Speaker Enrollment) (Type A) on page 5-89.

Refer to Troubleshooting on page 5-129.

▼ Security Setting (Type A)

If a passcode is set, the system cannot be activated unless the passcode is input.

NOTE

Do this function only when parked. It is too distracting to attempt while driving and you may make too many errors to be effective.

Passcode setting

1. Press the pick-up button or talk button with a short press.
2. **Say:** [Beep] “Setup”
3. **Prompt:** “Select one of the following: Pairing options, confirmation prompts, language, passcode, select phone or select music player.”
4. **Say:** [Beep] “Passcode”
5. **Prompt:** “Passcode is disabled. Would you like to enable it?”
6. **Say:** [Beep] “Yes”
7. **Prompt:** “Please say a 4-digit passcode. Remember this passcode. It will be required to use this system.”

8. **Say:** [Beep] “XXXX” (Say a desired 4-digit passcode, “PCode”.)
9. **Prompt:** “Passcode XXXX (Passcode, PCode). Is this correct?”
10. **Say:** [Beep] “Yes”
11. **Prompt:** “Passcode is enabled.”

Using Bluetooth® Hands-Free with a passcode

1. Press the pick-up button or talk button with a short press.
2. **Prompt:** “Hands-Free system is locked. State the passcode to continue.”
3. **Say:** [Beep] “XXXX” (Say the set passcode “PCode”.)
4. If the correct passcode is input, voice guidance “XXXXXX... (Ex. “Mary’s device”) (Device tag) is connected” is announced.

If the passcode is incorrect, voice guidance “XXXX (4-digit passcode, Pcode) incorrect passcode, please try again” is announced.

Canceling the passcode

NOTE

Do this function only when parked. It is too distracting to attempt while driving and you may make too many errors to be effective.

1. Press the pick-up button or talk button with a short press.
2. **Say:** [Beep] “Setup”
3. **Prompt:** “Select one of the following: Pairing options, confirmation prompts, language, passcode, select phone or select music player.”
4. **Say:** [Beep] “Passcode”
5. **Prompt:** “Passcode is enabled. Would you like to disable it?”
6. **Say:** [Beep] “Yes”
7. **Prompt:** “Passcode is disabled.”

Confirmation Prompts

The confirmation prompt confirms the command content to the user before advancing to the operation requested by the user. When this function is turned on, the system reads out the voice input command previously received and confirms whether the command is correct before advancing to the command execution.

When the confirmation prompt function is turned on:

(Ex. "Calling John's device. Is this correct?")

When the confirmation prompt function is turned off:

(Ex. "Calling John's device.")

NOTE

If the confirmation prompt function is turned off when making an emergency call, the system reads out and confirms the command before executing it.

1. Press the pick-up button or talk button with a short press.
2. **Say:** [Beep] "Setup"
3. **Prompt:** "Select one of the following: Pairing options, confirmation prompts, language, passcode, select phone or select music player."
4. **Say:** [Beep] "Confirmation prompts"
5. **Prompt:** "Confirmation prompts are on/off. Would you like to turn confirmation prompts off/on?"
6. **Say:** [Beep] "Yes"
7. **Prompt:** "Confirmation prompts are off/on."

▼ **Voice Recognition Learning Function (Speaker Enrollment) (Type A)**

The voice recognition learning function enables voice recognition appropriate to the characteristics of the user's voice. If the recognition of the voice input commands to the system is not adequate, this function can largely improve the system's voice recognition of the user. If your voice can be recognized sufficiently without using this function, you may not realize the added benefit of the function. To register your voice, the voice input command list must be read out. Read out the list when the vehicle is parked. Perform the registration in as quiet a place as possible (page 5-87). The registration must be performed completely. The required time is a few minutes. The user needs to be seated in the driver's seat with the voice input command list for voice recognition learning visible.

When voice recognition learning is done for the first time

1. Press the pick-up button or talk button with a short press.
2. **Say:** [Beep] "Voice training"
3. **Prompt:** "This operation must be performed in a quiet environment while the vehicle is stopped. See the owner's manual for the list of required training phrases. Press and release the talk button when you are ready to begin. Press the hang-up button to cancel at any time."
4. Press the talk button with a short press.
5. The voice guidance reads out the voice input command number (refer to the voice input command list for voice recognition learning). (Ex. "Please read phrase 1")

Bluetooth®

6. **Say:** [Beep] “0123456789” (Say the voice input command for voice recognition learning (1 to 8) according to the voice guidance.)
7. **Prompt:** “Speaker enrollment is complete.”

NOTE

If an error occurred in the voice recognition learning, re-learning can be done by pressing the talk button with a short press.

Voice recognition re-learning

If voice recognition learning has already been done.

1. Press the pick-up button or talk button with a short press.
2. **Say:** [Beep] “Voice training”
3. **Prompt:** “Enrollment is enabled/disabled. Would you like to disable/enable or retrain?”
4. **Say:** [Beep] “Retrain”
5. **Prompt:** “This operation must be performed in a quiet environment while the vehicle is stopped. See the owner's manual for the list of required training phrases. Press and release the talk button when you are ready to begin. Press the hang-up button to cancel at any time.”
6. Press the talk button with a short press.
7. The voice guidance reads out the voice input command number (refer to the voice input command list for voice recognition learning). (Ex. “Please read phrase 1”)
8. **Say:** [Beep] “0123456789” (Say the voice input command for voice recognition learning (1 to 8) according to the voice guidance.)
9. **Prompt:** “Speaker enrollment is complete.”

NOTE

If an error occurred in the voice recognition learning, re-learning can be done by pressing the talk button with a short press.

Voice input command list for voice recognition learning

When reading out, the following points must be observed:

- Read out the numbers one at a time correctly and naturally. (For example, “1234” must be read out “one, two, three, four” not “twelve, thirty four”.)
- Do not read out parentheses. “(” and hyphens “-” are used for separating numbers in a phone number.

Ex.

“(888) 555-1212” must be spoken “Eight, eight, eight, five, five, five, one, two, one, two.”

Phrase	Command
1	0123456789
2	(888) 555-1212
3	Call
4	Dial
5	Setup
6	Cancel
7	Continue
8	Help

NOTE

- The applicable phrase appears in the audio display.
- After user voice registration is completed, voice guidance “Speaker enrollment is complete” is announced.

Voice recognition learning on/off

1. Press the pick-up button or talk button with a short press.
2. **Say:** [Beep] “Voice training”
3. **Prompt:** “Enrollment is enabled/disabled. Would you like to disable/enable or retrain?”
4. **Say:** [Beep] “Disable” or “Enable”
5. When “Disable” is spoken, the voice recognition learning is turned off. When “Enable” is spoken, the voice recognition learning is turned on.
6. **Prompt:** “Speaker Enrollment is disabled/enabled.”

▼ Bluetooth® Preparation (Type B)

Device pairing

To use Bluetooth® audio and Hands-Free, the device equipped with Bluetooth® has to be paired to the unit using the following procedure. A maximum of seven devices including Bluetooth® audio devices and hands-free mobile phones can be paired.

NOTE

- *The Bluetooth® system may not operate for 1 or 2 minutes after the ignition is switched to ACC or ON. However, this does not indicate a problem. If the Bluetooth® system does not connect automatically after 1 or 2 minutes have elapsed, make sure that the Bluetooth® setting on the device is normal and attempt to reconnect the Bluetooth®-enabled device from the vehicle side.*
- *If Bluetooth®-enabled devices are used in the following locations or conditions, connection via Bluetooth® may not be possible.*
 - *The device is in a location hidden from the center display such as behind or under a seat, or inside the glove compartment.*
 - *The device contacts or is covered by a metal object or body.*
 - *The device is set to power-saving mode.*

Pairing Procedure

1. Select the  icon on the home screen to display the Settings screen.
2. Select the **Devices** tab.
3. Select **Bluetooth**.
4. Turn the Bluetooth® setting on.
5. Select **Add New Device** to display the message and switch to the device operation.
6. Using your device, perform a search for the Bluetooth® device (Peripheral device).
7. Select “Mazda” from the device list searched by the device.

Bluetooth®

8. **(Device with Bluetooth® version 2.0)**
Input the displayed 4-digit pairing code into the device.
(Device with Bluetooth® version 2.1 or higher)
Make sure the displayed 6-digit code on the audio is also displayed on the device, and touch the **Yes**.
Connection permission and phonebook access permission for your mobile device may be required depending on the mobile device.
9. If pairing is successful, the functions of the device connected to Bluetooth® are displayed.
10. **(Devices compatible with Mazda Email / SMS function)**
SMS (Short Message Service) messages, and E-mail for the device are downloaded automatically. A download permission operation for your device may be required depending on the device.

NOTE

When Call history and messages are downloaded automatically, each automatic download setting must be on. Refer to Communication Settings on page 5-112.

After a device is registered, the system automatically identifies the device. By activating Bluetooth® Hands-Free again, or by activating Bluetooth® Hands-Free first after switching the ignition from OFF to ACC, the device connection condition is indicated in the center display.

IMPORTANT note about pairing and automatic reconnection:

- **If pairing is redone on the same mobile phone device, first clear “Mazda” displayed on the Bluetooth® setting screen of the mobile device.**
- When the OS of the device is updated, the pairing information may be deleted. If this happens, reprogram the pairing information to the Bluetooth® unit.
- Before you pair your device, make sure that Bluetooth® is “ON”, both on your phone and on the vehicle.

Device selection

If several devices have been paired, the Bluetooth® unit links the device last paired. If you would like to link a different paired device, it is necessary to change the link. The order of device priority after the link has been changed is maintained even when the ignition is switched off.

Connecting other devices

1. Select the  icon on the home screen to display the Settings screen.
2. Select the **Devices** tab.
3. Select **Bluetooth**.
4. Turn the Bluetooth® setting on.
5. Select the name of the device you would like to connect.
6. **Phone and Audio** selection
Connects both devices as hands-free and Bluetooth® audio.
 - Phone Only** selection
Connects as a hands-free device.
 - Audio Only** selection
Connects as Bluetooth® audio.

NOTE

The following functions can be used for the Hands-free or audio.

- Hands-free: Phone calls and E-mail/SMS
- Audio: Bluetooth® audio, Pandora®, Aha™, Stitcher™ radio

Disconnecting a device

1. Select the  icon on the home screen to display the Settings screen.
2. Select the **Devices** tab.
3. Select **Bluetooth**.
4. Turn the Bluetooth® setting on.
5. Select the device name which is currently connected.
6. Select **Disconnect**.

Deleting a device

Selecting and deleting devices



1. Select the  icon on the home screen to display the Settings screen.
2. Select the **Devices** tab.
3. Select **Bluetooth**.
4. Turn the Bluetooth® setting on.
5. Select the device name which you would like to delete.
6. Select **Unpair This Device**.
7. Select **Yes**.

Deleting all devices

1. Select the  icon on the home screen to display the Settings screen.
2. Select the **Devices** tab.
3. Select **Bluetooth**.
4. Select **Custom Settings**.
5. Select **Unpair All Paired Devices**.
6. Select **Yes**.

Changing PIN code

PIN code (4 digits) can be changed.

1. Select the  icon on the home screen to display the Settings screen.
2. Select the **Devices** tab.
3. Select **Bluetooth**.
4. Select **Custom Settings**.
5. Select **Change Pairing Code**.
6. Input the new PIN code to be set.
7. Select .

▼ Available Language (Type B)

The Bluetooth® Hands-Free System applies to the following languages:

- English
- Spanish
- French

Refer to Settings on page 5-53.

▼ Voice Recognition (Type B)

In this section, the basic operation of the voice recognition is explained.

Activating Voice Recognition

Press the talk button.

Ending Voice Recognition

Use one of the following methods:

- Press the hang-up button.
- Say, “Cancel”.
- Operate the commander switch or the center display (only when vehicle is stopped).

Skipping Voice Guidance (for faster operation)

Press and release the talk button.

Troubleshooting for Voice Recognition

If you do not understand an operation method while in the voice recognition mode, say “Tutorial” or “Help”.

Commands useable anytime during voice recognition

“Go Back” and “Cancel” are commands which can be used at anytime during voice recognition.

Returning to previous operation

To return to the previous operation, say, “Go Back” while in voice recognition mode.

Cancel

To put the Bluetooth® Hands-Free system in standby mode, say, “Cancel” while in voice recognition mode.

To prevent a deterioration in the voice recognition rate and voice quality, the following points should be observed:

- **The voice recognition cannot be performed while voice guidance or the beep sound is operating. Wait until the voice guidance or the beep sound is finished before saying your commands.**
- Phone related commands are available only when your phone is connected via Bluetooth®. Make sure your phone is connected via Bluetooth® before you operate phone related voice commands.
- Music play commands, such as Play Artist and Play Album can be used only in USB audio mode.
- Do not speak too slowly or loudly (no loud voice).
- Speak clearly, without pausing between words or numbers.
- Dialects or different wording other than hands-free prompts cannot be recognized by voice recognition. Speak in the wording specified by the voice commands.
- It is not necessary to face the microphone or approach it. Speak the voice commands while maintaining a safe driving position.
- Close the windows and/or the convertible top to reduce loud noises from outside the vehicle, or turn down the airflow of the air-conditioning system while Bluetooth® Hands-Free is being used.
- Make sure the vents are not directing air up towards the microphone.

NOTE

*If the voice recognition performance is not satisfactory.
Refer to Troubleshooting on page 5-129.*

▼ Audio Operation Using Voice Recognition (Type B)

Voice command

When the talk button is pressed and the following command is spoken, the audio or navigation can be operated. The commands in the () can be omitted. The specified name and number are put into the {}.

Standard command

Voice command	Function
cancel	Ends the voice recognition mode.
(go) back	Returns to the previous operation.
help	Usable commands can be verified.
tutorial	Basic voice commands and methods of use can be verified.
(go to) home (screen)/main menu	Moves to the home screen.
(go to) communication	Moves to the communication screen.
(go to) navigation	Moves to the navigation screen.
(go to) entertainment (menu)	Moves to the entertainment screen.
(go to) settings	Moves to the setting screen.
(go to) favorites	Moves to the favorites screen.

Communication (phone) related command

Voice command	Function
Call {name in phonebook} (mobile/ home/work/other) Example: "Call John Mobile"	Call to the contact in the downloaded phonebook. Refer to Making a Call on page 5-103.
Redial	Call to the last contact you called. Refer to Making a Call on page 5-103.
Callback	Call to the last contact who called you. Refer to Making a Call on page 5-103.

Entertainment (audio) related command

Voice command	Function	Corresponding audio source
(Go to/Play) AM (Radio)	Switches the audio source to AM radio.	All
(Go to/Play) FM (Radio)	Switches the audio source to FM radio.	All
(Go to/Play) Bluetooth (Audio)	Switches the audio source to BT audio.	All
(Go to/Play) Pandora	Switches the audio source to Pandora®	All
(Go to/Play) Aha (Radio)	Switches the audio source to Aha™ Radio.	All
(Go to/Play) Stitcher	Switches the audio source to Stitcher™ Radio.	All
(Go to/Play) USB 1	Switches the audio source to USB 1.	All
(Go to/Play) USB 2	Switches the audio source to USB 2.	All
Play Playlist {Playlist name}	Plays the selected playlist.	USB
Play Artist {Artist name}	Plays the selected artist.	USB
Play Album {Album name}	Plays the selected album.	USB
Play Genre {Genre name}	Plays the selected genre.	USB
Play Folder {Folder name}	Plays the selected folder.	USB

Navigation related command*

For the navigation screen voice commands, refer to the separate navigation system manual.

NOTE

- *Some commands cannot be used depending on the grade and specification.*
- *Some commands cannot be used depending on the device connection conditions and the use conditions.*
- *The commands are examples of the available commands.*

Bluetooth® Hands-Free (Type A)

▼ Making a Call

Phonebook Usage

Telephone calls can be made by saying the name of a person (voice tag) whose phone number has been registered in Bluetooth® Hands-Free in advance. Refer to Phonebook registration.

1. Press the pick-up button or talk button with a short press.
2. **Say:** [Beep] “Call”
3. **Prompt:** “Name please.”
4. **Say:** [Beep] “XXXXX...” (Ex. “John's phone”)” (Say a voice tag registered in the phonebook.)
5. **Prompt:** “Calling XXXXX... (Ex. “John's phone”) XXXX (Ex. “at home”). Is this correct?” (Voice tag and phone number location registered in phonebook).
6. **Say:** [Beep] “Yes”
7. **Prompt:** “Dialing”

NOTE

The “Call” command and the voice tag can be combined.

Ex. In Step 2, say, “Call John's phone”, then, Steps 3 and 4 can be skipped.

Phonebook registration

Phone numbers can be registered to the Bluetooth® Hands-Free phonebook.

NOTE

Do this function only when parked. It is too distracting to attempt while driving and you may make too many errors to be effective.

1. Press the pick-up button or talk button with a short press.
2. **Say:** [Beep] “Phonebook”
3. **Prompt:** “Select one of the following: New entry, edit, list names, delete, erase all or import contact.”
4. **Say:** [Beep] “New entry”
5. **Prompt:** “Name please.”
6. **Say:** [Beep] “XXXXX...” (Ex. “Mary's phone”)” (Say a voice tag for the name registered.)
7. **Prompt:** “Adding XXXXX... (Ex. “Mary's phone”) (Registered voice tag). Is this correct?”
8. **Say:** [Beep] “Yes”
9. **Prompt:** “Home, Work, Mobile, or Other?”
10. **Say:** [Beep] “Mobile” (Say “Home”, “Work”, “Mobile”, or “Other”, for the desired location to be registered.)
11. **Prompt:** “Mobile (Location to be registered). Is this correct?”
12. **Say:** [Beep] “Yes”
13. **Prompt:** “Number, please.”
14. **Say:** [Beep] “XXXXXXXXXXXX” (Say the phone number to be registered.)
15. **Prompt:** “XXXXXXXXXXXX (Phone number registration). After the beep, continue to add numbers, or say Go-Back to re-enter the last entered numbers, or press the Pick-Up button to save the number.”

Bluetooth®**16. (Registration)**

Press the pick-up button or say “Enter”, then go to Step 17.

(Adding/inputting telephone number)

Say, “XXXX” (desired telephone number), then go to Step 15.

(Telephone number correction)

Say, “Go Back”. The prompt replies, “Go Back. The last entered numbers have been removed.”. Then go back to Step 13.

17. Prompt: “Number saved. Would you like to add another number for this entry?”

18. Say: [Beep] “Yes” or “No”.

19. If “Yes”, an additional phone number registration can be made for the same entry.

If “No”, the system returns to standby status.

(Import contact)

Phonebook data from your device (Mobile phone) can be sent and registered to your Bluetooth® Hands-Free phonebook using Bluetooth®.

1. Press the pick-up button or talk button with a short press.
2. **Say:** [Beep] “Phonebook”
3. **Prompt:** “Select one of the following: New entry, edit, list names, delete, erase all or import contact.”
4. **Say:** [Beep] “Import contact”
5. **Prompt:** “The hands free System is ready to receive a contact from a phone. Only a home, a work, and a mobile number can be imported, This process requires operation of a mobile phone. refer to the phone's manual for more information”

6. Device (Mobile phone) operation:

Select one entry from the phonebook and send it using Bluetooth®.

7. Prompt: “X (Number of locations which include data) numbers have been imported. What name would you like to use for these numbers?”

8. Say: [Beep] “XXXXX... (Ex. “Mary's phone”)” (Say a voice tag for the name registered.)

9. Prompt: “Adding XXXXX... (Ex. “Mary's phone”) (Voice tag). Is this correct?”

10. Say: [Beep] “Yes”

11. Prompt: “Number saved. Would you like to import another contact?”

12. Say: [Beep] “Yes” or “No”

13. If “Yes”, the procedure proceeds to Step 5.

If “No”, the system returns to standby status.

Editing phonebook

The data registered to the Bluetooth® Hands-Free phonebook can be edited.

NOTE

Do this function only when parked. It is too distracting to attempt while driving and you may make too many errors to be effective.

1. Press the pick-up button or talk button with a short press.
2. **Say:** [Beep] “Phonebook”
3. **Prompt:** “Select one of the following: New entry, edit, list names, delete, erase all or import contact.”
4. **Say:** [Beep] “Edit”
5. **Prompt:** “Please say the name of the entry you would like to edit or say, “List names”.”

6. **Say:** [Beep] “XXXXX... (Ex. “Mary’s phone”)” (Say the voice tag for the registered name to be edited in the phonebook.)
7. **Prompt:** “Home, Work, Mobile, or Other?”
8. **Say:** [Beep] “Home” (Say the registered location to be edited: “Home”, “Work”, “Mobile”, or “Other”).
9. **Prompt:** “XXXXX... (Ex. “Mary’s phone”) (Registered voice tag) XXXX (Ex. “Home”) (Registered location). Is this correct?”
10. **Say:** [Beep] “Yes”
11. **Prompt:** “The current number is XXXXXXXXXXXX (Ex. “555-1234”) (Currently registered number). New number, please.”

NOTE

If there was no previous phone number registered to a location (Ex. “Work”), the prompt will only read out “Number, please”

12. **Say:** [Beep] “XXXXXXXXXXXX (Ex. “555-5678”)” (Say the new phone number to be registered.)
13. **Prompt:** “XXXXXXXX (Telephone number) After the beep, continue to add numbers, or say Go-Back to re-enter the last entered numbers, or press the Pick-Up button to save the number.”

14. (Number Change)

Press the pick-up button, then go to Step 15.

(Adding/inputting telephone number)

Say, “XXXX” (desired telephone number), then go to Step 13.

(Telephone number correction)

Say, “Go Back”. The prompt replies, “Go Back. The last entered numbers have been removed. Number, please.”. Then go back to Step 12.

15. **Prompt:** “Number changed.”

Phonebook data deletion

(Erasing individual phonebook data)

Individual data registered to the Bluetooth® Hands-Free phonebook can be cleared.

NOTE

Do this function only when parked. It is too distracting to attempt while driving and you may make too many errors to be effective.

1. Press the pick-up button or talk button with a short press.
2. **Say:** [Beep] “Phonebook”
3. **Prompt:** “Select one of the following: New entry, edit, list names, delete, erase all or import contact.”
4. **Say:** [Beep] “Delete”
5. **Prompt:** “Please say the name of the entry you would like to delete or say, “List names”. ”
6. **Say:** [Beep] “XXXXX... (Ex. “John’s phone”) ” (Say the registered voice tag to be deleted from the phonebook.)
7. **Prompt:** “Deleting XXXXX... (Ex. “John’s phone”) (Registered voice tag) Home (Registered location). Is this correct?”
8. **Say:** [Beep] “Yes”

Bluetooth®

9. **Prompt:** “XXXXX... (Ex. “John's phone”) (Registered voice tag) Home (Registered location) deleted.”

(Complete deletion of the phonebook data)

All data registered to the Bluetooth® Hands-Free phonebook can be erased.

NOTE

Do this function only when parked. It is too distracting to attempt while driving and you may make too many errors to be effective.

1. Press the pick-up button or talk button with a short press.
2. **Say:** [Beep] “Phonebook”
3. **Prompt:** “Select one of the following: New entry, edit, list names, delete, erase all or import contact.”
4. **Say:** [Beep] “Erase all”
5. **Prompt:** “Are you sure you want to erase everything from your Hands Free system phonebook?”
6. **Say:** [Beep] “Yes”
7. **Prompt:** “You are about to delete everything from your Hands Free system phonebook. Do you want to continue?”
8. **Say:** [Beep] “Yes”
9. **Prompt:** “Please wait, erasing the Hands Free system phonebook.”
10. **Prompt:** “Hands-Free system phonebook erased.”

Read-out of names registered to the Bluetooth® Hands-Free phonebook

Bluetooth® Hands-Free can read out the list of names registered to its phonebook.

1. Press the pick-up button or talk button with a short press.
2. **Say:** [Beep] “Phonebook”

3. **Prompt:** “Select one of the following: New entry, edit, list names, delete, erase all or import contact.”
4. **Say:** [Beep] “List names”
5. **Prompt:** “XXXXX..., XXXXX..., XXXXX... (Ex. “John's phone”, Mary's phone, Bill's phone)” (Voice guidance reads out the voice tags registered to the phonebook.)
Press the talk button with a short press during the read-out at the desired name, and then say one of the following voice commands to execute it.
 - “Continue”: Continues the list readout.
 - “Call”: Calls the registered phonebook data when the talk button is short-pressed.
 - “Edit”: Edits the registered phonebook data when the talk button is short-pressed.
 - “Delete”: Deletes the registered phonebook data when the talk button is short-pressed.
 - “Previous”: Returns to the previous phonebook data in read-out when the talk button is short-pressed.
6. **Prompt:** “End of list, would you like to start from the beginning?”
7. **Say:** [Beep] “No”
8. The procedure returns to Step 3.

Redial Function

Redialing the number of the person previously dialed using the phone is possible.

1. Press the pick-up button or talk button with a short press.
2. **Say:** [Beep] “Redial”
3. **Prompt:** “Dialing”

Telephone Number Input

NOTE

Practice this while parked until you are confident you can do it while driving in a non-taxing road situation. If you are not completely comfortable, make all calls from a safe parking position, and only start driving when you can devote your full attention to driving.

1. Press the pick-up button or talk button with a short press.
2. **Say:** [Beep] “Dial”
3. **Prompt:** “Number, please”
4. **Say:** [Beep] “XXXXXXXXXXXXX (Telephone number)”
5. **Prompt:** “XXXXXXXXXXXXX. (Telephone number) After the beep, continue to add numbers, or say Go-Back to re-enter the last entered numbers, or press the Pick-Up button to execute dialing.”
6. **(Dialing)**
Press the pick-up button or say “Dial”, then go to Step 7.
(Adding/inputting telephone number)
Say, “XXXX” (desired telephone number), then go to Step 5.
(Telephone number correction)
Say, “Go Back”. The prompt replies, “Go Back. The last entered numbers have been removed.”. Then go back to Step 3.
7. **Prompt:** “Dialing”

NOTE

*The “Dial” command and a telephone number can be combined.
Ex. In Step 2, say, “Dial 123-4567” then, Steps 3 and 4 can be skipped.*

Emergency calls

A call can be made to the emergency phone number (911: U.S.A./Canada, 066: Mexico) using the voice input command. It may not function properly in some areas in Mexico.

1. Press the pick-up button or talk button with a short press.
2. **Say:** [Beep] “Emergency”
3. - **U.S.A./Canada vehicles - Prompt:** “Dialing “911”, is this correct?”
- **Mexico vehicles - Prompt:** “Dialing “066”, is this correct?”
4. **Say:** [Beep] “Yes”
5. **Prompt:** “Dialing”

▼ Receiving an Incoming Call

1. **Prompt:** “Incoming call, press the pick-up button to answer”
2. To accept the call, press the pick-up button.
To reject the call, press the hang-up button.

▼ Hanging Up a Call

Press the hang-up button during the call. A beep sound will confirm that call is ended.

▼ Mute

The microphone can be muted during a call.

1. Press the talk button with a short press.
2. **Say:** [Beep] “Mute”
3. **Prompt:** “Microphone muted”

Canceling mute

1. Press the talk button with a short press.
2. **Say:** [Beep] “Mute off”
3. **Prompt:** “Microphone unmuted”

▼ Transferring a Call from Hands-Free to a Device (Mobile Phone)

Communication between the hands-free unit and a device (Mobile phone) is canceled, and the line can be switched to a standard call using a device (Mobile phone).

1. Press the talk button with a short press.
2. **Say:** [Beep] “Transfer call”
3. **Prompt:** “Transferred call to phone”

▼ Transferring a Call from a Device (Mobile Phone) to Hands-Free

Communication between devices (Mobile phone) can be switched to Bluetooth® Hands-Free.

1. Press the talk button with a short press.
2. **Say:** [Beep] “Transfer call”
3. **Prompt:** “Transferred call to Hands Free system”

▼ Call interrupt

A call can be interrupted to receive an incoming call from a third party. Switch to a new incoming call using the following methods.

Method 1

1. Press the pick-up button.
2. **Prompt:** “Swapping calls.”

Method 2

1. Press the talk button with a short press.
2. **Say:** [Beep] “Swap calls”
3. **Prompt:** “Swapping calls.”

NOTE

- *To refuse an incoming call, press the hang-up button.*
- *After receiving a new incoming call, the previous call is placed on hold.*

Switching calls

Switching back to the previous call can also be done.

Method 1

1. Press the pick-up button.
2. **Prompt:** “Swapping calls.”

Method 2

1. Press the talk button with a short press.
2. **Say:** [Beep] “Swap calls”
3. **Prompt:** “Swapping calls.”

Three-way call function

1. Press the talk button with a short press.
2. **Say:** [Beep] “Join calls”
3. **Prompt:** “Joining calls”

Making a call using a telephone number

1. Press the talk button with a short press.
2. **Say:** [Beep] “Dial”
3. **Prompt:** “Number, please”
4. **Say:** [Beep] “XXXXXXXXXXXXX (Telephone number)”
5. **Prompt:** “XXXXXXXXXXXXX. (Telephone number) After the beep, continue to add numbers, or say Go-Back to re-enter the last entered numbers, or press the Pick-Up button to execute dialing.”
6. **(Dialing)**
Press the pick-up button or say “Dial”, then go to Step 7.
(Adding/inputting telephone number)
Say, “XXXX” (desired telephone number), then go to Step 5.
(Telephone number correction)
Say, “Go Back”. The prompt replies, “Go Back. The last entered numbers have been removed.”. Then go back to Step 3.
7. **Prompt:** “Dialing”

Making calls using the phonebook

1. Press the talk button with a short press.
2. **Say:** [Beep] “Call”
3. **Prompt:** “Name please.”
4. **Say:** [Beep] “XXXXX... (Ex. “John’s phone”)” (Say a voice tag registered in the phonebook.)
5. **Prompt:** “Calling XXXXX... (Ex. “John’s phone”) XXXX (Ex. “at home”). Is this correct?” (Voice tag and phone number location registered in phonebook).
6. **Say:** [Beep] “Yes”
7. **Prompt:** “Dialing”

Redialing function

1. Press the talk button with a short press.
2. **Say:** [Beep] “Redial”
3. **Prompt:** “Dialing”

Ending the current call

Press the hang-up button during the call.

▼ **DTMF (Dual Tone Multi-Frequency Signal) Transmission**

This function is used when transmitting DTMF via the user’s voice. The receiver of a DTMF transmission is generally a home telephone answering machine or a company’s automated guidance call center (When you send tone signals back according to the voice guidance recording).

1. Press the talk button with a short press.
2. **Say:** [Beep] “XXXX... send” (Say DTMF code)
3. **Prompt:** “Sending XXXX... (DTMF code)”

Bluetooth® Hands-Free (Type B)

▼ **Making a Call**

Phonebook Usage

Telephone calls can be made by saying the contact name in the downloaded phonebook or the name of a person whose phone number has been registered in the Bluetooth® Hands-Free. Refer to Import contact (Download Phonebook).

1. Press the talk button.
2. Wait for the beep sound.
3. **Say:** “Call XXXXX... (Ex. “John”) Mobile”.
4. Follow the voice guidance to place the call.

Screen operation

1. Select the  icon on the home screen to display the Communication screen.
2. Select **Contacts** to display the contact list.
3. Select the contact you would like to call to display the details for the contact.
4. Select the desired phone number to make the call.

Import contact (Download Phonebook)

Phonebook data from your device (Mobile phone) can be sent and registered to your Bluetooth® Hands-Free phonebook using Bluetooth®.

(Automatic downloading)

The “Auto Download Contacts” setting must be on. When hands-free is connected to the device, the phonebook is downloaded automatically. Refer to Communication Settings on page 5-112.

(Manually downloading)

If the “Auto Download Contacts” setting is off, download the phonebook using the following procedure.

1. Select the  icon on the home screen to display the Communication screen.
2. Select **Contacts** to display the contact list.
3. Select **Edit Contacts**.
4. Select **Import All Contacts** or **Import Selected Contact** to switch to the device operation.
5. If **Import All Contacts** is selected, select **Download**.
6. Download will be started from the mobile phone.

NOTE

- If “Import All Contacts” is performed after saving the phonebook to the Bluetooth® unit, the phonebook will be overwritten.
- A maximum of 1,000 contacts can be registered to the phonebook.
- Phonebook, incoming/outgoing call record, and favorite memories are exclusive to each mobile phone to protect privacy.

Favorites Contacts

A maximum of 50 contacts can be registered. It will take less time to make a call after registering the telephone number. In addition, you do not have to look for the person you want to call in the phonebook.

Registering your favorites

1. Select the  icon on the home screen to display the Communication screen.
2. Select **Favorites** to display the favorites list.
3. Select **Add/Edit Communication Favorites**.
4. Select **Add New Contact** or **Add New Contact Details**.
5. Select from the displayed list.

NOTE

When “Add New Contact” is selected, information such as the selected person’s name is also registered. In addition, when “Add New Contact Details” is selected, only the telephone number of the selected person is registered.

Calling a favorite

1. Select the  icon on the home screen to display the Communication screen.
2. Select **Favorites** to display the favorites list.
3. **(If only one phone number is registered to contact)**
Select the contact information you would like to call. Go to Step 5.
(If multiple phone numbers are registered to contact)
Select the contact you would like to call to display the screen indicating the details for the contact. Go to Step 4.
4. Select the phone number you would like to call.
5. Select **Yes**.

Deleting a favorite

1. Select the  icon on the home screen to display the Communication screen.
2. Select **Favorites** to display the favorites list.
3. Select **Add/Edit Communication Favorites**.
4. Select **Delete**.
5. Select the contact information which you would like to delete.
6. Select **Delete**.

Changing the display order of your favorites list

1. Select the  icon on the home screen to display the Communication screen.
2. Select **Favorites** to display the favorites list.
3. Select **Add/Edit Communication Favorites**.
4. Select **Move**.
5. The contact can be moved after it is selected.
6. Slide the contact or move it using the commander switch, then select **OK**.

Changing contact name of your favorites

1. Select the  icon on the home screen to display the Communication screen.
2. Select **Favorites** to display the favorites list.
3. Select **Add/Edit Communication Favorites**.
4. Select **Rename**.
5. Select the contact to display the keyboard screen.
6. If a new name is input and **OK** is selected, the contact name is stored.



NOTE

If the contact is long-pressed when the favorites list is displayed, the contact information can be edited (deleted, moved).

Telephone Number Input

NOTE

Practice this while parked until you are confident you can do it while driving in a non-taxing road situation. If you are not completely comfortable, make all calls from a safe parking position, and only start driving when you can devote your full attention to driving.

1. Select the  icon on the home screen to display the Communication screen.
2. When **Dial Phone** is pressed, the dial pad is displayed.
3. Input the telephone number using the dial pad.
4. Select  to make the call.

Numeral or symbol entry

Use the dial pad.

Long-press the  to input +.

Select  to delete the currently input value.

Long-press  to delete all input values.

Redial Function

Makes a call to the last person called (latest person on outgoing call record) from the mobile phone/vehicle.

1. Press the talk button.
2. Wait for the beep sound.
3. **Say:** “Redial”

Call back Function

Makes a call to the last person who called your (latest person on incoming call record) mobile phone/vehicle.

1. Press the talk button.
2. Wait for the beep sound.
3. **Say:** “Call back”

Mobile 911 (U.S.A./Canada only)

If the vehicle is involved in a moderate to severe collision, a call is made automatically to 911 from the connected device. The “Emergency Assistance Call” setting must be on.

Refer to Communication Settings on page 5-112.

CAUTION

Though the system can be set to not call 911, doing so will defeat the purpose of the system. Mazda recommends that the Mobile 911 system remain activated.

NOTE

- **Mobile 911 is a secondary function of the audio entertainment system. Therefore, the mobile 911 function does not assure that the call is always made to 911 after an accident occurs.**
 - *A Hands-free device must be paired and connected. The 911 operator can verify the vehicle's position information using the Hands-free device GPS if equipped.*
1. If the vehicle is involved in a moderate to severe collision, notification of the call to 911 is made via audio and screen display. To cancel the call, press **Cancel Emergency Assistance Call** or hang-up button within 10 seconds.
 2. If **Cancel Emergency Assistance Call** or hang-up button is not pressed within 10 seconds, the call is made to 911 automatically.

▼ Receiving an Incoming Call









When an incoming call is received, the incoming call notification screen is displayed. The “Incoming Call Notifications” setting must be on.

Refer to Communication Settings on page 5-112.

To accept the call, press the pick-up button on the audio control switch or select **Answer** on the screen.

To reject the call, press the hang-up button on the audio control switch or select **Ignore** on the screen.

The following icons are displayed on the screen during a call. Icons which can be used differ depending on use conditions.

Icon	Function
	Displays the Communication menu.
	Ends the call.
	Transferring a call from hands-free to a mobile phone Communication between the Bluetooth® unit and a device (mobile phone) is canceled, and an incoming call will be received by the device (mobile phone) like a standard call.
	Transferring a call from a device (mobile phone) to hands-free Communication between devices (mobile phone) can be switched to Bluetooth® Hands-Free.
	Mute The microphone can be muted during a call. When selected again, the mute is canceled.
	To make a 3-way call, select the contacts from the following: Call History : Call History is displayed. Contacts : The phonebook is displayed. Dial : The dial pad is displayed. Input the phone number. The device may be unusable depending on the contractual content.
	The call on hold is made to make a 3-way call. The device may be unusable depending on the contractual content.
	Switches the call on hold.
	DTMF (Dual Tone Multi-Frequency Signal) Transmission This function is used when transmitting DTMF via the dial pad. The receiver of a DTMF transmission is generally a home telephone answering machine or a company's automated guidance call center. Input the number using a dial pad.

NOTE

- If the ignition is switched off during a hands-free call, the line is transferred to the device (Mobile phone) automatically.
- If the DTMF code has two or more digits or symbols, each one must be transmitted individually.

▼ Call Interrupt

A call can be interrupted to receive an incoming call from a third party.

When **[Hold + Answer]** is selected or the pick-up button on the steering wheel is pressed, the current call is held and the system switches to the new incoming call.

When **[End + Answer]** is selected, the current call is ended and the system switches to the new incoming call (GSM network only).

When **[Ignore]** is selected or the hang-up button on the steering wheel is pressed, an incoming call is refused.

NOTE

- The function may not be available depending on the contractual content of the mobile device.
- The function may not be operable depending on the type of the telephone network and the mobile device.

▼ Receiving and Replying to Messages (available only with E-mail/SMS compatible phones)

SMS (Short Message Service) messages, and E-mail received by connected devices can be downloaded, displayed, and played (read by the system).

Additionally, replies can also be made to calls and messages in the received messages.

Downloading messages

Up to 20 new messages can be downloaded and displayed from a connected device.

NOTE

For E-mail, 20 messages for each account can be downloaded.

(Automatic downloading)

The “Auto Download Email” (E-mail) or “Auto Download Text Message” (SMS) setting must be on. A message is downloaded automatically when the Bluetooth® unit is connected to the device. Refer to Communication Settings on page 5-112.

(Manually downloading)

When the “Auto Download Email” (E-mail) or “Auto Download Text Message” (SMS) setting is off, the message is downloaded using the following procedure.

1. Select the  icon on the home screen to display the Communication screen.
2. Select **[Email]** or **[Text Messages]** to display the Inbox.
3. Select **[Update Inbox]**.
4. Download will be started from the mobile phone.

NOTE

- *Attached data is not downloaded.*
- *Messages up to 1 kilobyte (E-mail)/ 140-bytes (SMS) can be downloaded.*
- *A message list is created for each device.*
- *If the connected device does not correspond to MAP 1.0, the AT command is used to download. The downloaded message indicates that it is already read.*
- *Downloading using the AT command may not function depending on the connected device.*

Receiving messages

(Method 1)

When a device receives a message, a message received notification is displayed. The “Email Notifications” (E-mail) or “Text Notifications” (SMS) setting must be on.









Refer to Communication Settings on page 5-112.

Select **Read** and display the message.

(Method 2)

1. Select the  icon on the home screen to display the Communication screen.
2. Select **Notifications** and display the new message list for E-mail and SMS.
3. Select the message you would like to display.

The following icons are displayed in the lower part of the details on the message. Icons which can be used differ depending on use conditions.

Icon	Function
	Displays the Communication menu.
	Displays the inbox.
	Plays back a message. When selected again, playback is temporarily stopped.
	Displays the previous message.
	Displays the next message.
	Only replies to the sender of the currently displayed message. Select the sentence on the displayed reply screen and select the sentence for sending from the preset message. Select Send .
	(Only E-mail) Replies to all members including CC. Select the sentence on the displayed reply screen and select the sentence for sending from the preset message. Select Send .
	Makes a call to a person who sent a message. For E-mail, this function may not work depending on the device.
	Deletes a message. The messages stored in a device is also deleted.

NOTE

Up to three preset messages can be selected.

Example of use (verify unread E-mail)

1. Select the  icon on the home screen to display the Communication screen.
2. Select **Email** to display the inbox.

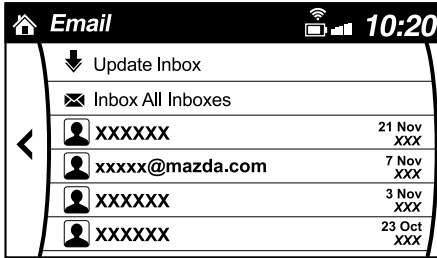



3. Select the unread message displayed in bold.
4. The details of the message are displayed and replying to the message, making a call, or playback can be performed.



Changing account for displaying (E-mail only)

1. Select **Inbox**.
2. Select the account which you would like to display. Only the messages for the selected account are displayed in the inbox.

Editing preset messages

1. Select the  icon on the home screen to display the Communication screen.
2. Select **Settings**.
3. Select **Edit Preset Messages**.
4. Select the preset message which you would like to edit. The keyboard screen is displayed.
5. When the message is input and  is selected, the message is stored as a preset message.

NOTE

- Select the  icon to change the language.
- Select the  icon to switch between capitalized and lower-case characters.
- Select the  icon to return to the previous screen without storing the edit.

▼ Communication Settings

Select the  icon on the home screen to display the Communication screen.
Select **Settings** to change the setting.

Item	Setting	Function
Bluetooth®	—	Go to Bluetooth® setting menu. Refer to Bluetooth® Preparation (Type B) on page 5-91.
Incoming Call Notifications	On/Off	Notifies when an incoming call is received.
Auto Download Text Message	On/Off	Downloads SMS automatically when the Bluetooth® unit is connected to the device.
Text Notifications	On/Off	Notifies when a new SMS is received.
Auto Download Email* ¹	On/Off	Downloads E-mail automatically when the Bluetooth® unit is connected to the device.
Email Notifications	On/Off	Notifies when a new Email is received.
Auto Download Call History	On/Off	Downloads Call History automatically when the Bluetooth® unit is connected to the device.
Auto Download Contacts* ¹	On/Off	Downloads the phonebook automatically when the Bluetooth® unit is connected to the device.
Ringtone	Car/Phone/Off	Changes the ringtone setting.
Phone Volume	Adjusts using the slider.	Adjusts the conversation volume.
VR and Ringtone	Adjusts using the slider.	Adjusts the voice guidance and ringtone volume.
Contacts Display Order	First Name, Last Name	Displays the contact information in alphabetical order of the first name.
	Last Name, First Name	Displays the contact information in alphabetical order of the last name.
Edit Preset Messages	—	Edits the preset message. Refer to Receiving and Replying to Messages (available only with E-mail/SMS compatible phones) on page 5-108.
Emergency Assistance Call	On/Off	Mobile Utilizes the Mobile 911 function.
Restore Factory settings	—	Initializes all Communication Settings.

*1 Depending on the device, it may be necessary to acquire download permission on the device side.

Bluetooth® Audio (Type A)

Applicable Bluetooth® specification (Recommended)

Ver. 2.0

Response profile

- A2DP (Advanced Audio Distribution Profile) Ver. 1.0/1.2
- AVRCP (Audio/Video Remote Control Profile) Ver. 1.0/1.3

A2DP is a profile which transmits only audio to the Bluetooth® unit. If your Bluetooth® audio device corresponds only to A2DP, but not AVRCP, you cannot operate it using the control panel of the vehicle's audio system. In this case, only the operations on the mobile device are available the same as when a portable audio device for a non-compliant Bluetooth® device is connected to the AUX terminal.

Function	A2DP	AVRCP	
		Ver. 1.0	Ver. 1.3
Playback	—	X	X
Pause	—	X	X
File (Track) up/down	—	X	X
Reverse	—	—	X
Fast-forward	—	—	X
Text display	—	—	X

X: Available
 —: Not available

NOTE

- The battery consumption of Bluetooth® audio devices increases while Bluetooth® is connected.
- If a general mobile phone device is USB connected during music playback over the Bluetooth® connection, the Bluetooth® connection is disconnected. For this reason, you cannot have music playback over a Bluetooth® connection and music playback using a USB connection at the same time.
- The system may not operate normally depending on the Bluetooth® audio device.

▼ How to Use the Bluetooth® Audio System

Switching to Bluetooth® audio mode

To listen to music or voice audio recorded to a Bluetooth® audio device, switch to the Bluetooth® audio mode to operate the audio device using the audio system control panel. Any Bluetooth® audio device must be paired to the vehicle's Bluetooth® unit before it can be used. Refer to Bluetooth® Preparation (Type A) on page 5-77.

1. Turn on the Bluetooth® audio device's power.
2. Switch the ignition to ACC or ON.
 Make sure that the “♪” symbol is displayed in the audio display. The symbol is not displayed if an un-paired Bluetooth® audio device is being used or the vehicle's Bluetooth® unit has a malfunction.

NOTE

Some Bluetooth® audio devices need a certain amount of time before the “♪” symbol is displayed.

Bluetooth®

- Press the media button (**MEDIA**) to switch to the Bluetooth® audio mode and start playback.

If the current device version is lower than AVRCP Ver. 1.3: “BT Audio” is displayed.

If the current device is AVRCP Ver. 1.3: The playback time is displayed.

NOTE

- If the Bluetooth® audio device does not begin playback, press the Play/Pause button (4).
- If a call is received on a hands-free mobile phone during playback from the Bluetooth® audio device, the playback is stopped. Playback from the Bluetooth® audio device resumes after the call ends.

Playback

- To listen to a Bluetooth® audio device over the vehicle's speaker system, switch the mode to Bluetooth® audio mode. (Refer to “Switching to Bluetooth® audio mode”)
- To stop playback, press the Play/Pause button (4).
- Press the button again to resume playback.

Selecting a file (track)**Selects the next file (track)**

Short-press the track up button (▶▶).

Selects the beginning of the current file (track)

Short-press the track down button (◀◀).

Fast-forward/Reverse (AVRCP Ver. 1.3)**Fast-forward**

Press and hold the fast-forward button (▶▶▶).

Reverse

Press and hold the reverse down button (◀◀◀).

Switching the display (only AVRCP Ver. 1.3)

The information displayed on the audio display changes as follows each time the text button (3) is pressed during playback.

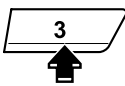
Button	Information displayed on audio display
	Elapsed time
	Album name
	Song name
	Artist name

NOTE

- If title information is not available, “NO TITLE” is displayed.
- This unit cannot display some characters. Characters which cannot be displayed are indicated by an asterisk (*).

Display scroll

Only 13 characters can be displayed at one time. To display the rest of the characters of a long title, press and hold the text button (3). The display scrolls the next 13 characters. Press and hold the text button (3) again after the last 13 characters have been displayed to return to the beginning of the title.

▼ Bluetooth® Audio Device Information Display

If a Bluetooth® audio device is connected, the following information is displayed in the audio display.

	AVRCP Ver. lower than 1.3	AVRCP Ver. 1.3
Device name	X	X
Title	—	X
Artist name	—	X
Album name	—	X
File number	—	X
Playback time	—	X
Folder number	—	—

X: Available
 —: Not available

NOTE

Some information may not display depending on the device, and if the information cannot be displayed, “NO TITLE” is indicated.

Bluetooth® Audio (Type B)

Applicable Bluetooth® specification (Recommended)

Ver. 1.1/1.2/2.0 + EDR/2.1 + EDR/3.0 (conformity)

Response profile

- A2DP (Advanced Audio Distribution Profile) Ver. 1.0/1.2
- AVRCP (Audio/Video Remote Control Profile) Ver. 1.0/1.3/1.4

Bluetooth®

A2DP is a profile which transmits only audio to the Bluetooth® unit. If your Bluetooth® audio device corresponds only to A2DP, but not AVRCP, you cannot operate it using the control panel of the vehicle's audio system. In this case, only the operations on the mobile device are available the same as when a portable audio device for a non-compliant Bluetooth® device is connected to the AUX terminal.

Function	A2DP	AVRCP		
		Ver. 1.0	Ver. 1.3	Ver. 1.4
Playback	X	X	X	X
Pause	X	X	X	X
File (Track) up/down	—	X	X	X
Reverse	—	—	X	X
Fast-forward	—	—	X	X
Text display	—	—	X	X
Repeat	—	—	Depends on device	Depends on device
Shuffle	—	—	Depends on device	Depends on device
Scan	—	—	Depends on device	Depends on device
Folder up/down	—	—	—	Depends on device

X: Available

—: Not available

NOTE

- *The battery consumption of Bluetooth® audio devices increases while Bluetooth® is connected.*
- *If a general mobile phone device is USB connected during music playback over the Bluetooth® connection, the Bluetooth® connection is disconnected. For this reason, you cannot have music playback over a Bluetooth® connection and music playback using a USB connection at the same time.*
- *The system may not operate normally depending on the Bluetooth® audio device.*

▼ How to Use the Bluetooth® Audio System

Switching to Bluetooth® audio mode

To listen to music or voice audio recorded to a Bluetooth® audio device, switch to the Bluetooth® audio mode to operate the audio device using the audio system control panel. Any Bluetooth® audio device must be paired to the vehicle's Bluetooth® unit before it can be used.

Refer to Bluetooth® Preparation (Type B) on page 5-91.

1. Turn on the Bluetooth® audio device's power.
2. Switch the ignition to ACC or ON.
3. Select the  icon on the home screen to display the Entertainment screen.
4. When **Bluetooth** is selected, switches to the Bluetooth® audio mode to begin playback.









NOTE

- If Bluetooth® audio is used after using Pandora®, Aha™ or Stitcher™ radio, the application on the mobile device has to be closed first.
- If the Bluetooth® audio device does not begin playback, select the  icon.
- If the mode is switched from Bluetooth® audio mode to another mode (radio mode), audio playback from the Bluetooth® audio device stops.

Playback

To listen to a Bluetooth® audio device over the vehicle's speaker system, switch the mode to Bluetooth® audio mode. (Refer to “Switching to Bluetooth® audio mode”)

After switching to the Bluetooth® audio mode, the following icons are displayed in the lower part of the display. Icons which can be used differ depending on the version of the Bluetooth® audio device which you are currently using.

Icon	Function
	Displays the Entertainment menu. Use to switch to a different audio source.
	(AVRCP Ver. 1.4 only) Displays the top level folder/file list. Select the folder which you want to select. The files in the selected folder are displayed. Select the file you want to play.
	(AVRCP Ver. 1.3 or higher) Replays the song currently being played repeatedly. When selected again, the songs in the folder are played repeatedly. Select it again to cancel. Icons change when the song is repeated or the folder is repeated.
	(AVRCP Ver. 1.3 or higher) Plays songs in the folder in random order. When selected again, the songs on the device are played in random order. Select it again to cancel. Icons change during folder shuffle or device shuffle.
	Scans the titles in a folder and plays the beginning of each song to aid in finding a desired song. When selected again, the beginning of each song on the device is played. When selected again, the operation is canceled and the song currently being played continues.
	Returns to the beginning of the previous song. Long-press to fast reverse. It stops when you remove your hand from the icon or the commander knob.
	Plays the Bluetooth® audio. When selected again, playback is temporarily stopped.
	Advances to the beginning of the next song. Long-press to fast forward. It stops when you remove your hand from the icon or the commander knob.
	Displays sound settings to adjust audio quality level. Refer to Volume/Display/Sound Controls on page 5-40.

▼ **Bluetooth® Audio Device
 Information Display**

If a Bluetooth® audio device is connected, the following information is displayed in the center display.

	AVRCP Ver. lower than 1.3	AVRCP Ver. 1.3	AVRCP Ver. 1.4 or higher
Device name	X	X	X
Remaining battery charge of device	X	X	X
Song name	—	X	X
Artist name	—	X	X
Album name	—	X	X
Playback time	—	X	X
Genre name	—	X	X
Album art image	—	—	—

X: Available
 —: Not available

NOTE

Some information may not display depending on the device, and if the information cannot be displayed, “Unknown - - -” is indicated.

▼ How to Use Pandora®**What is Pandora®?**

Pandora®*1 is free personalized Internet radio. Simply enter a favorite artist, track, genre, and Pandora® will create a personalized station that plays their music and more like it. Rate songs by giving thumbs-up and thumbs-down feedback to further refine your station, discover new music and help Pandora® play only music you like.

*1 Pandora®, the Pandora® logo, and the Pandora® trade dress are trademarks or registered trademarks of Pandora Media, Inc., used with permission.









NOTE

To operate Pandora® from your Bluetooth® device, perform the following in advance:

- Create Pandora® account on the Web.
- Create Pandora® station using Pandora® application.
- Install Pandora® application on your device.

Playback

Select the  icon on the home screen to display the Entertainment screen. When Pandora is selected, the following icons are indicated in the bottom part of the center display.

Icon	Function
	Displays the Entertainment menu. Use to switch to a different audio source.
	Displays the station list. Use to switch to other stations.
	Thumbs-Down Press the  icon to tell Pandora® not to play this track.
	Thumbs-Up Press the  icon to tell Pandora® “you like this track” and it helps to bring in more tracks like it to your station.
	Bookmarking Bookmarks the song or artist currently being played.
	Plays the track. When selected again, playback is temporarily stopped.
	Goes to the next song.

Icon	Function
	Displays sound settings to adjust audio quality level. Refer to Volume/Display/Sound Controls on page 5-40.

NOTE

- The skip function may not be available depending on the device.
- The number of skips is limited by Pandora®.
- If the  icon is selected when the skip song function is running, the next song is skipped.

Selection from station list

Selection can be made from a programmed radio station list.

1. Select the  icon.
2. Select the desired radio station.

NOTE

When **Shuffle** is selected, songs randomly selected from the radio station list are played.

Selecting the sort method

The displayed order of the station list can be changed.

1. Select the  icon.
2. Select **Sort By:**.
3. Select **Date** to display in the order starting from the newly created station.
4. Select **A-Z** to display in alphabetical order.

NOTE

The displayed order of **Shuffle** cannot be changed.

Bookmarking

You can bookmark song or artist to check out later on the Web.

1. Select the  icon.
2. Select **Bookmark Song** to bookmark the song.
3. Select **Bookmark Artist** to bookmark the artist.

▼ How to Use Aha™**What is Aha™?**

Aha^{*1} is an application which can be used to enjoy various Internet content such as Internet radio and podcasts.

Stay connected to your friends activities by getting updates from Facebook and Twitter.

Using the location-based service, nearby services and destinations can be searched or real-time local information can be obtained.

For details on Aha, refer to “<http://www.aharadio.com/>”.

*1 Aha, the Aha logo, and the Aha trade dress are trademarks or registered trademarks of Harman International Industries, Inc., used with permission.





NOTE











- *The service content provided by Aha varies depending on the country in which the user resides. In addition, the service is not available in some countries.*
- *To operate Aha from your Bluetooth® device, perform the following in advance:*
 - *Install the Aha application to your device.*
 - *Create an Aha account for your device.*
 - *Log onto Aha using your device.*
 - *Select the preset station on your device.*

Playback

Select the  icon on the home screen to display the Entertainment screen. When aha is selected, the following icons are displayed at the bottom of the center display. The displayed icon differs depending on the selected station.

In addition, icons other than the following icons may be displayed.

Icon	Function
	Displays the Entertainment menu. Use to switch to a different audio source.
	Displays the main menu. Use to switch to other stations.
	Displays the content list. Use to switch to other desired content on the station.
	Shout Records voice. Records voice and posts it as playable audio to Facebook and other social stations.

Icon	Function
	Like *2 Evaluates the current content as “Like”.
	Dislike *2 Evaluates the current content as “Dislike”.
	Reverses for 15 seconds.
	Map (vehicles with navigation system) Displays the destination searched by the location based services on the navigation system.
	Call A call can be made to the telephone number of a shop searched using the Location Based Services. Available when a device is connected as a Hands-Free.
	Returns to the previous content.
	Pauses playback of the content. When selected again, playback resumes.
	Goes to the next content.
	Fast-forwards for 30 seconds.
	Displays sound settings to adjust audio quality level. Refer to Volume/Display/Sound Controls on page 5-40.

*2 Some stations may use alternate variations of Like and Dislike, based on station type or provider.

Main menu

Select the ☰ icon.

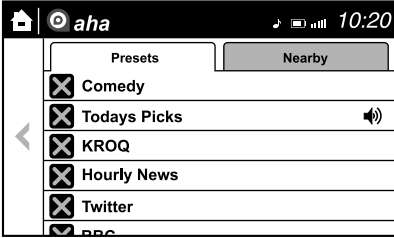

Switch the tab and select the station category.

Tab	Function
Presets	Displays the preset station list set on the device. Select the preset station name to play the station content.
Nearby	Select the desired station. Guidance is provided to the searched destination near the vehicle's position. You can designate desired categories previously set using the filter setting on your device.



NOTE

The available Location Based Services may differ because the services depend on the content provided by Aha™.

Example of use (Location Based Services)

1. Select the desired station from the “Nearby” tab on the main menu.
 The destination name or address playback starts in the order of the destination name list.



2. When the  icon is selected, the currently displayed destination is displayed on the navigation system (vehicles with navigation system).
3. When the  icon is selected, a phone call is placed to the currently displayed destination.
4. Select the  icon to display the content list.
 Selection of other destinations from the list can be made.

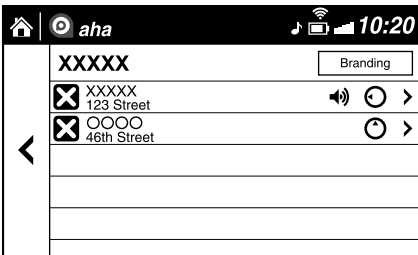

Shout

Some social stations, such as Facebook or Karaoke, support the ability to record and share voice messages using the “Shout” function.

1. Select the  icon and start the countdown (3, 2, 1, 0). Recording starts when the countdown reaches zero.
2. Records voice.
3. Select **[Save]** and store/post the recording.

NOTE

- Recordable time varies depending on the station (Max. 30 seconds).
- Recording stops automatically when the recordable time has elapsed. You can then post or delete the recording.

▼ How to Use Stitcher™ Radio**What is Stitcher™ Radio?**

Stitcher™¹ radio is an application which can be used to listen to Internet radio or stream podcasts.

Recommended content is automatically selected by registering content which you put into your favorites, or by pressing the Like or Dislike button.

For details on Stitcher™ Radio, refer to “<http://stitcher.com/>”.

*1 Stitcher™, the Stitcher™ logo, and the Stitcher™ trade dress are trademarks or registered trademarks of Stitcher, Inc., used with permission.







NOTE



To operate Stitcher™ Radio from your Bluetooth® device, perform the following in advance:

- *Install the Stitcher™ Radio application to your device.*
- *Create a Stitcher™ Radio account for your device.*
- *Log onto Stitcher™ Radio using your device.*

Playback

Select the  icon on the home screen to display the Entertainment screen. When Stitcher is selected, the following icons are indicated in the bottom part of the center display.

Icon	Function
	Displays the Entertainment menu. Use to switch to a different audio source.
	Displays the station list. Use to switch to other stations.
	Dislike Evaluates the current program as “Dislike”.
	Like Evaluates the current program as “Like”.
	Adds the current station to your favorites or deletes the current station from your favorites.
	Reverses for 30 seconds.

Icon	Function
	Plays the station. Select it again to pause playback.
	Goes to the next station.
	Displays sound settings to adjust audio quality level. Refer to Volume/Display/Sound Controls on page 5-40.

Station list

1. Select the  icon to display the station list.
 - ① Favorites station name: Select to display the program registered to your favorites.
 - ② Category name: A recommended category selected from your favorites by Stitcher™ is displayed.
 Select it to display the category program.

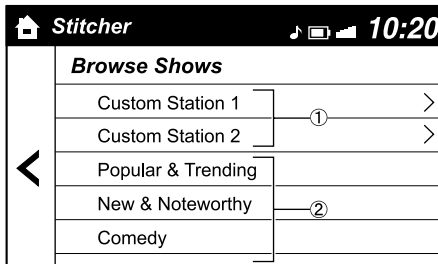

2. Select the program name to play it.

Add to your favorites

If the current program has not been registered to your favorites, it can be registered to your favorites.

1. Select the ★ icon to display the favorites station which the registration can be added.
2. Select the station name which you want to register.
3. Select **[OK]** to add the program to the selected favorites station.

NOTE

- *Multiple favorites stations can be selected and registered.*
- *Favorites stations registered by oneself as well those set by default are displayed.*

Delete from your favorites

If the current program has already been registered to your favorites, the program can be deleted from your favorites.

1. Select the ★ icon.
2. The program is automatically deleted from the favorites station.

Troubleshooting

Mazda Bluetooth® Hands-Free Customer Service

If you have any problems with Bluetooth®, contact our toll-free customer service center.

- **U.S.A.**
Phone: 800-430-0153 (Toll-free)
Web: www.mazdausa.com/mazdaconnect
- **Canada**
Phone: 800-430-0153 (Toll-free)
Web: www.mazdahandsfree.ca
- **Mexico**
Center of Attention to Client (CAC)
Phone: 01-800-01-MAZDA (Toll-free)
Web: www.mazdamexico.com.mx

Bluetooth® Device pairing, connection problems

Symptom	Cause	Solution method
Unable to perform pairing	—	First make sure the device is compatible with the Bluetooth® unit, and then check whether the Bluetooth® function and the Find Mode/Visible setting*1 on the device are turned on. If pairing is still not possible after this, contact an Authorized Mazda Dealer or Mazda Bluetooth® Hands-Free Customer Service.
Pairing cannot be performed again	The pairing information paired to the Bluetooth® unit or device is not recognized correctly.	Perform pairing using the following procedure. •Clear “Mazda” stored in the device. •Perform pairing again.
Unable to perform pairing	The Bluetooth® function and the Find Mode/Visible setting*1 on the device may turn off automatically after a period of time has elapsed depending on the device.	Check whether the Bluetooth® function and the Find Mode/Visible setting*1 on the device are turned on and pairing or reconnect.
Does not connect automatically when starting the engine		
Automatically connects, but then disconnects suddenly		
Disconnects intermittently	The device is in a location in which radio wave interference can occur easily, such as in a bag or in a rear pocket of a pair of pants.	Move the device to a location in which radio wave interference is less likely to occur.
Does not connect automatically when starting the engine	The pairing information is updated when the device OS is updated.	Perform pairing again.

*1 Setting which detects the existence of a device external to the Bluetooth® unit

NOTE

- *When the OS of the device is updated, the pairing information may be deleted. If this happens, reprogram the pairing information to the Bluetooth® unit.*
- *If you pair your phone which has already been paired to your vehicle more than once in the past, you need to delete “Mazda” on your mobile device. Then, execute the Bluetooth® search on your mobile device once again, and pair to a newly detected “Mazda”.*
- *Before you pair your device, make sure that Bluetooth® is “ON”, both on your phone and on the vehicle.*
- *If Bluetooth®-enabled devices are used in the following locations or conditions, connection via Bluetooth® may not be possible.*
 - *The device is in a location hidden from the center display such as behind or under a seat, or inside the glove compartment.*
 - *The device contacts or is covered by a metal object or body.*
 - *The device is set to power-saving mode.*
- *Different Bluetooth®-enabled devices can be used for Bluetooth® Hands-Free and Bluetooth® audio. For example, device A can be connected as a Bluetooth® Hands-Free device and device B can be connected as a Bluetooth® audio device. However, the following may occur when they are used at the same time.*
 - *The Bluetooth® connection of the device is disconnected.*
 - *Noise occurs in the Hands-Free audio.*
 - *Hands-Free operates slowly.*

Voice recognition related problems

Symptom	Cause	Solution method
Poor voice recognition	<ul style="list-style-type: none"> • Excessive, slow speech. • Excessive, forceful speech (shouting). • Speaking before the beep sound has ended. • Loud noise (speaking or noise from outside/inside vehicle). • Airflow from A/C is blowing against the microphone. • Speaking in off-standard expressions (dialect). 	Regarding the causes indicated on the left, be careful with how you speak. In addition, when numbers are spoken in a sequence, recognition ability will improve if no stop is placed between the numbers.
False recognition of numbers		
Poor voice recognition	There is a malfunction in the microphone.	A poor connection or malfunction with the microphone may have occurred. Consult an Authorized Mazda Dealer.
Phone-related voice recognition is disabled	There is a problem with the connection between the Bluetooth® unit and the device.	If there is any malfunction after checking the pairing situation, check for device pairing or connection problems.

Symptom	Cause	Solution method
Names in the phonebook are not easily recognized	The Bluetooth® system is under a condition in which recognition is difficult.	By carrying out the following measures, the rate of recognition will improve. <ul style="list-style-type: none"> *Clear memory from the phonebook which is not used very often. *Avoid shortened names, use full names. (Recognition improves the longer the name is. By not using names such as “Mom”, “Dad”, recognition will improve.)
When operating the audio, a song name is not recognized	Song names cannot be recognized by voice.	—
You want to skip guidance	—	Guidance can be skipped by quickly pressing and releasing the Talk button.

Regarding problems with calls

Symptom	Cause	Solution method
When starting a call, vehicle noise from the other party can be heard	For about three seconds after starting a call, the Bluetooth® unit's Noise Suppression function requires time to adapt to the call environment.	This does not indicate a problem with the device.
The other party cannot be heard or the speaker's voice is quiet	The volume is set at zero or low.	Increase the volume.

Other problems

Symptom	Cause	Solution method
The indication for the remaining battery is different between the vehicle and the device	The indication method is different between the vehicle and the device.	—
When a call is made from the vehicle, the telephone number is updated in the incoming/outgoing call record but the name does not appear	The number has not been registered into the phonebook.	If the number has been registered into the phonebook, the incoming/outgoing call record is updated by the name in the phonebook when the engine is restarted.
The cell phone does not synchronize with the vehicle regarding the incoming/outgoing call record	Some types of cell phones do not synchronize automatically.	Operate the cell phone for synchronization.
It takes a long time to complete the function for changing the language	A maximum of 60 seconds is required.	—

Interior Equipment

Sunvisors

When you need a sunvisor, lower it for use in front.

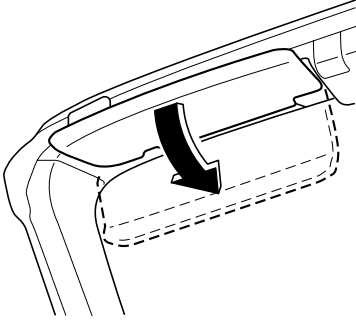

▼ Vanity Mirrors

To use the vanity mirror, lower the sunvisor.

Interior Lights

NOTE

Do not leave the lights on for long periods while the engine is turned off. Otherwise the battery power could be depleted.

Overhead Light

Switch Position	Overhead Light
OFF	Light off
DOOR	*Light is on when any door is open *Light is on or off when the illuminated entry system is on
ON	Light on

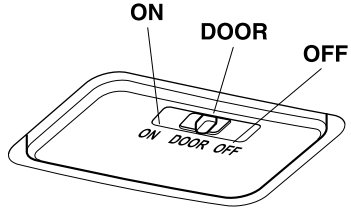

Trunk Light

The trunk light is on when the lid is open and off when it's closed.

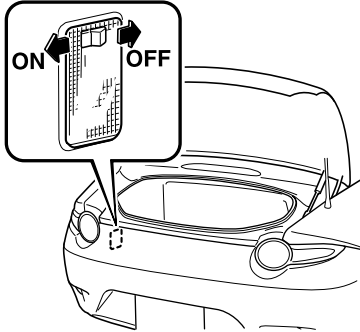

NOTE

To prevent the battery from being discharged, do not leave the trunk open for a long period when the engine is not running.

▼ **Illuminated Entry System**

When the illuminated entry system operates, the overhead lights turn on in the following conditions:

- The driver's door is unlocked after the ignition is switched OFF.
- The ignition is switched OFF with all doors closed.

NOTE

- *The illuminated entry system operates when the overhead light switch is in the DOOR position.*
- *The illumination time differs depending on the operation.*
- **Battery saver**
If an interior light is left on with the ignition switched OFF, the light is turned off automatically after about 30 minutes to prevent battery depletion.
- *The operation of the illuminated entry system can be changed.*
Refer to Personalization Features on page 9-9.

Interior Equipment

Accessory Sockets

The accessory socket is located deep in the back of the footwell on the passenger side. Only use genuine Mazda accessories or the equivalent requiring no greater than 120 W (DC 12 V, 10 A).

The ignition must be switched to ACC or ON.

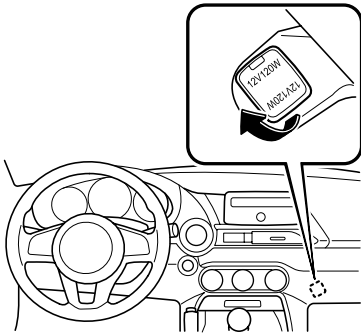

CAUTION

- To prevent accessory socket damage or electrical failure, pay attention to the following:
 - Do not use accessories that require more than 120 W (DC 12 V, 10 A).
 - Do not use accessories that are not genuine Mazda accessories or the equivalent.
 - Close the cover when the accessory socket is not in use to prevent foreign objects and liquids from getting into the accessory socket.
 - Correctly insert the plug into the accessory socket.
 - Do not insert the cigarette lighter into the accessory socket.
- Noise may occur on the audio playback depending on the device connected to the accessory socket.
- Depending on the device connected to the accessory socket, the vehicle's electrical system may be affected, which could cause the warning light to illuminate. Disconnect the connected device and make sure that the problem is resolved. If the problem is resolved, disconnect the device from the socket and switch the ignition off. If the problem is not resolved, consult an Authorized Mazda Dealer.

NOTE

To prevent discharging of the battery, do not use the socket for long periods with the engine off or idling.

Cup Holder

! WARNING

Never use a cup holder to hold hot liquids while the vehicle is moving:

Using a cup holder to hold hot liquids while the vehicle is moving is dangerous. If the contents spill, you could be scalded.

Do not put anything other than plastic bottles, cups or drink cans in cup holders:

Putting objects other than plastic bottles, cups or drink cans in a cup holder is dangerous. During sudden braking or maneuvering, occupants could be hit and injured, or objects could be thrown around the vehicle, causing interference with the driver and the possibility of an accident. Only use a cup holder for plastic bottles, cups or drink cans.

! CAUTION

- Do not place plastic bottles without caps in the cup holders. Otherwise, the contents may spill while the vehicle is being driven.
- Do not place excessive weight on the cup holders such as by resting your hands or elbows on them. Otherwise, the cup holders could be damaged.
- If a passenger is present, install the front cup holder to the rear console. Otherwise, a knee might hit it and cause the contents to spill.

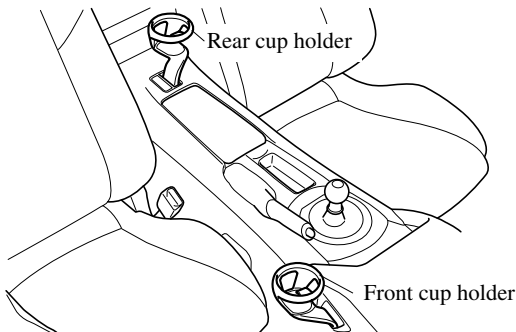

Interior Equipment

Removing cup holders

Use both hands when removing the cup holder.

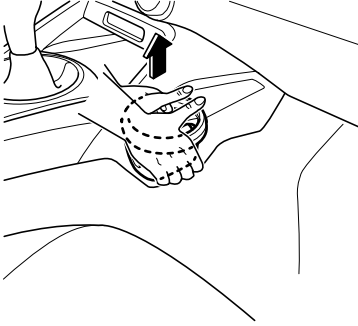

Installing cup holders



When installing a cup holder, insert it all the way into the installation hole and make sure that it is secured in place. Otherwise, the cup holder may fall off while the vehicle is being driven and cause the beverage to spill.

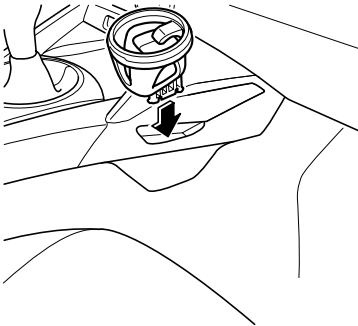

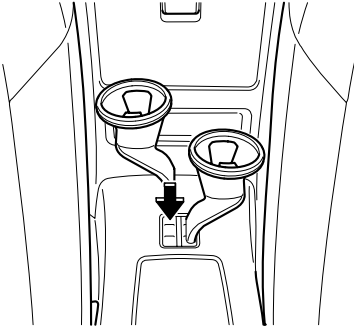

NOTE

- *The front cup holder can be removed and installed to the rear console.*

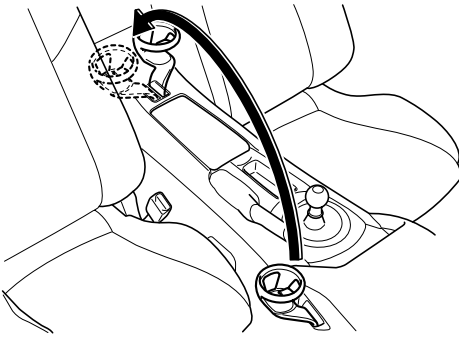

- *The rear cup holder is designed for use on the rear console and cannot be installed to the front side.*

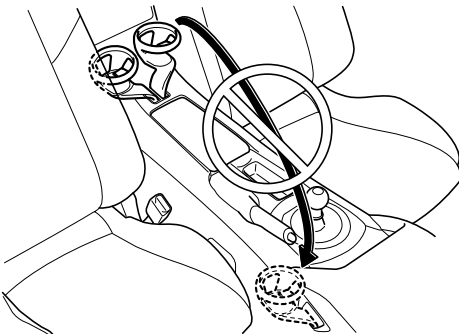

Interior Equipment

Storage Compartments

! WARNING

Keep storage boxes closed when driving:

Driving with the storage boxes open is dangerous. To reduce the possibility of injury in an accident or a sudden stop, keep the storage boxes closed when driving.

Do not put articles in storage spaces with no lid:

Putting articles in storage spaces with no lid is dangerous as they could be thrown around the cabin if the vehicle is suddenly accelerated and cause injury depending on how the article is stored.

! CAUTION

Do not leave lighters or eyeglasses in the storage boxes while parked under the sun. A lighter could explode or the plastic material in eyeglasses could deform and crack from high temperature.

▼ Console Box

To use, open the lid.

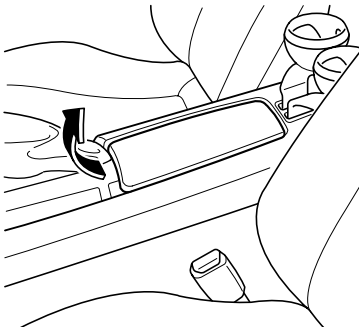

▼ Seat Side Box

! CAUTION

When using the rear console cup holders, remove any cups before opening the seat side box. If the seat side box is opened with cups still in them, the lid will hit the cups and cause the contents to spill.

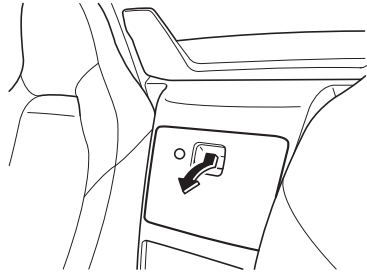

To open, press the latch down to open the seat side box.

Insert the auxiliary key and turn it clockwise to lock, counterclockwise to unlock.

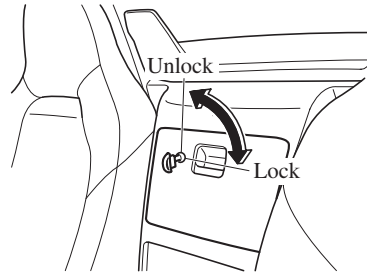

▼ Back Trim Storage Box

Small items can be stored in the back trim storage box.

(Soft top model)

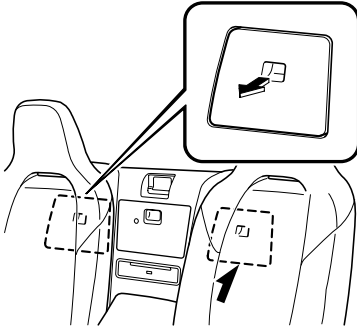

(Retractable fastback model)

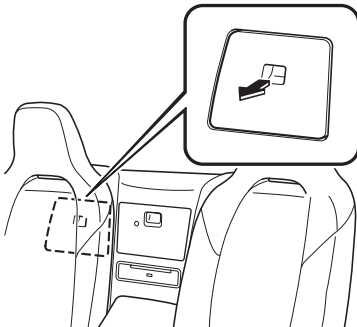

To use the back trim storage box

1. Slide the seat all the way forward and fold the seatback forward.
Refer to Seat Operation on page 2-4.
2. Remove the lids.

When finished, return the seat to its original position and secure it. After returning the seat to its original position, make sure the seat is secured by attempting to lightly move it forward and backward.

⚠ CAUTION

Do not forcefully push objects into the back trim storage box. Otherwise, the box could be damaged.

Interior Equipment

Windblocker

This windblocker reduces rear wind blast into the cabin when driving with the convertible top down.

(Soft top model)

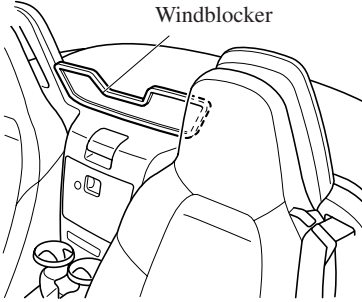

(Retractable fastback model)

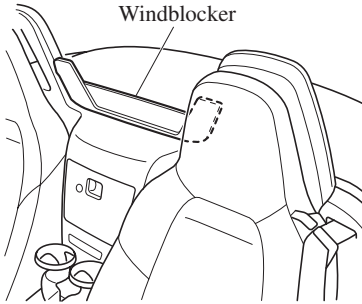

6

Maintenance and Care

How to keep your Mazda in top condition.

Essential Information	6-2
Introduction	6-2
Scheduled Maintenance.....	6-4
Scheduled Maintenance (U.S.A., Canada, and Puerto Rico).....	6-4
Scheduled Maintenance (Mexico)	6-13
Maintenance Monitor.....	6-20
Owner Maintenance.....	6-22
Owner Maintenance Precautions	6-22
Hood.....	6-24
Engine Compartment Overview	6-26
Engine Oil	6-27
Engine Coolant.....	6-29
Brake/Clutch Fluid.....	6-31
Washer Fluid	6-31
Body Lubrication	6-32
Wiper Blades.....	6-33
Battery.....	6-36
Key Battery Replacement	6-38
Tires.....	6-41
Light Bulbs.....	6-45
Fuses	6-54
Appearance Care.....	6-59
Exterior Care.....	6-59
Interior Care	6-68

Essential Information

Introduction

Be careful not to hurt yourself when inspecting your vehicle, replacing a tire, or doing some kind of maintenance such as car washing.

In particular, wear thick work gloves such as cotton gloves when touching areas that are difficult to see while inspecting or working on your vehicle. Doing inspections or procedures with your bare hands could cause injury.

If you are unsure about any procedure it describes, we strongly urge you to have a reliable and qualified service shop perform the work, preferably an Authorized Mazda Dealer.

Factory-trained Mazda technicians and genuine Mazda parts are best for your vehicle. Without this expertise and the parts that have been designed and made especially for your Mazda, inadequate, incomplete, and insufficient servicing may result in problems. This could lead to vehicle damage or an accident and injuries.

For expert advice and quality service, consult an Authorized Mazda Dealer.

To continue warranty eligibility and to protect your investment, it is your responsibility to properly maintain your vehicle according to factory recommended schedules outlined in this manual. As part of this you must keep your maintenance records, receipts, repair orders and any other documents as evidence this maintenance was performed. You must present these documents, should any warranty coverage disagreement occur. Failure to do so can result in your warranty being voided either in whole or in part.

This evidence may consist of the following:

- The Mazda Scheduled Maintenance Record, refer to the Warranty Booklet, must be completely filled out showing mileage, repair order number, date for each service, and signed by a qualified automotive service technician who service vehicles.
- Original copies of repair orders or other receipts that include the mileage and date the vehicle was serviced. Each receipt should be signed by a qualified automotive service technician.
- For self maintenance, a statement that you completed the maintenance yourself, displaying mileage and the date the work was performed. Also, receipts for the replacement parts (fluid, filters, etc.) indicating the date and mileage must accompany this statement.

NOTE

If you elect to perform maintenance yourself or have your vehicle serviced at a location other than an Authorized Mazda Dealer, Mazda requires that all fluids, parts and materials must meet Mazda standards for durability and performance as described in this manual.

Claims against the warranty resulting from lack of maintenance, as opposed to defective materials or authorized Mazda workmanship, will not be honored.

Any auto repair shop using parts equivalent to your Mazda's original equipment may perform maintenance. **But we recommend that it always be done by an Authorized Mazda Dealer using genuine Mazda parts.**

Selecting "Maintenance Monitor" enables the system to notify you of your vehicle's approaching inspection/servicing period (page 6-20).

The malfunction diagnosis connector is designed exclusively for connecting the specially designed device to perform on-board diagnosis.

Do not connect any devices other than the specially designed malfunction diagnosis devices for servicing. If any device other than the malfunction diagnosis device is connected, it may affect the vehicle's electrical devices or lead to damage such as battery depletion.

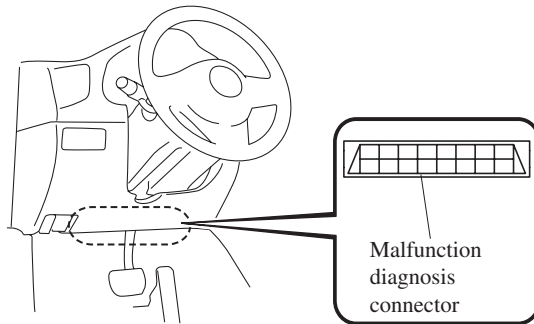

Scheduled Maintenance

Scheduled Maintenance (U.S.A., Canada, and Puerto Rico)

Follow Schedule 1 if the vehicle is operated mainly where none of the following conditions (severe driving conditions) apply.

- Repeated short-distance driving
- Driving in dusty conditions
- Driving with extended use of brakes
- Driving in areas where salt or other corrosive materials are used
- Driving on rough or muddy roads
- Extended periods of idling or low-speed operation
- Driving for long periods in cold temperatures or extremely humid climates
- Driving in extremely hot conditions
- Driving in mountainous conditions continually

If any do apply, follow Schedule 2. (Canada residents follow Schedule 2.)

Vehicles using Engine Oil Flexible Maintenance

Engine Oil Flexible Maintenance is available for U.S.A. and Puerto Rico residents whose vehicle is operated mainly where none of the following conditions apply:

- Extended periods of idling or low-speed operation such as police car, taxi or driving school car
- Driving in dusty conditions

If any do apply, follow Schedule 2 with engine oil fixed maintenance.

Once engine oil flexible maintenance is selected, the vehicle calculates the remaining oil life based on engine operating conditions. The vehicle lets you know when an oil change is due by illuminating the wrench indicator light in the instrument cluster. Change the oil as soon as possible within the next 500 km (300 mile) or 15 days. Refer page 6-20 for the details. Mazda Genuine 0W-20 Oil and Castrol® 0W-20 Oil are required to achieve optimum performance.

NOTE

- *Please ensure that the Flexible Oil Maintenance Setting is reset after each Oil and Filter replacement.*
- *For maintenance guidelines beyond the miles/months listed, follow the maintenance intervals provided in the Scheduled Maintenance Tables.*

Scheduled Maintenance

▼ Schedule 1

U.S.A. and Puerto Rico residents - Engine oil flexible maintenance interval

Use when the maintenance monitor for “Oil Change” is set to “Flexible”. For details, see maintenance monitor. (page 6-20)

Maintenance Interval	Number of months or kilometers (miles), whichever comes first.								
	Months	12	24	36	48	60	72	84	96
	×1000 km	16	32	48	64	80	96	112	128
	×1000 miles	10	20	30	40	50	60	70	80
ENGINE									
Drive belts			I				I		
Engine oil & filter* ¹	Replace when wrench indicator light is ON. (Max interval: 12 months/16,000 km (10,000 miles))								
COOLING SYSTEM									
Engine coolant* ²	Replace at first 192,000 km (120,000 miles) or 10 years; after that, every 96,000 km (60,000 miles) or 5 years.								
FUEL SYSTEM									
Air filter	Replace when any equivalent timing of replacing engine oil. (Max interval: 36 months/60,000 km (37,500 miles))								
Fuel lines and hoses* ³		I		I		I		I	
Hoses and tubes for emission* ³				I					I
IGNITION SYSTEM									
Spark plugs	Replace every 120,000 km (75,000 miles).								
CHASSIS and BODY									
Brake lines, hoses and connections		I		I		I		I	
Disc brakes	I	I	I	I	I	I	I	I	I
Manual transmission oil	Replace every 96,000 km (60,000 miles) or 4 years.								
Tire (Rotation)* ⁴	Rotate when any equivalent timing of replacing engine oil. (Max interval: 8,000 km (5,000 miles))								
Steering operation and linkages		I		I		I		I	
Front and rear suspension, ball joints and wheel bearing axial play		I		I		I		I	
Rear differential oil	* ⁵								
Driveshaft dust boots		I		I		I		I	
Bolts and nuts on chassis and body		T		T		T		T	
Exhaust system and heat shields				I					I
Emergency flat tire repair kit (if installed)* ⁶	Inspect annually.								

Scheduled Maintenance

Chart symbols:

I: Inspect: Inspect and clean, repair, adjust, fill up, or replace if necessary.

T: Tighten

Remarks:

- *1 The engine oil and filter must be changed at least once a year or within 16,000 km (10,000 miles) since last engine oil and filter change. The system must be reset whenever replacing the engine oil regardless of the message/wrench indicator light display.
- *2 Use of FL-22 is recommended when replacing engine coolant. Using engine coolant other than FL-22 may cause serious damage to the engine and cooling system.
- *3 According to state/provincial and federal regulations, failure to perform maintenance on these items will not void your emissions warranties. However, Mazda recommends that all maintenance services be performed at the recommended time or mileage/kilometer period to ensure long-term reliability.
- *4 The Tire Pressure Monitoring System (TPMS) initialization must be performed so that the system operates normally (if equipped).
- *5 If this component has been submerged in water, the oil should be replaced.
- *6 Check the tire repair fluid expiration date every year when performing the periodic maintenance. Replace the tire repair fluid bottle with new one before the expiration date.

Scheduled Maintenance

U.S.A. and Puerto Rico residents - Fixed maintenance interval

Use when the maintenance monitor for “Oil Change” is set to “Fixed”. For details, see maintenance monitor. (page 6-20)

Maintenance Interval	Number of months or kilometers (miles), whichever comes first.								
	Months	6	12	18	24	30	36	42	48
	×1000 km	12	24	36	48	60	72	84	96
	×1000 miles	7.5	15	22.5	30	37.5	45	52.5	60
ENGINE									
Drive belts						I			
Engine oil & filter	R	R	R	R	R	R	R	R	R
COOLING SYSTEM									
Engine coolant*1	Replace at first 192,000 km (120,000 miles) or 10 years; after that, every 96,000 km (60,000 miles) or 5 years.								
FUEL SYSTEM									
Air filter						R			
Fuel lines and hoses*2					I				I
Hoses and tubes for emission*2									I
IGNITION SYSTEM									
Spark plugs	Replace every 120,000 km (75,000 miles).								
CHASSIS and BODY									
Brake lines, hoses and connections					I				I
Disc brakes		I			I		I		I
Manual transmission oil									R
Tire (Rotation)*3*4	Rotate every 12,000 km (7,500 miles).								
Steering operation and linkages					I				I
Front and rear suspension, ball joints and wheel bearing axial play					I				I
Rear differential oil	*5								
Driveshaft dust boots					I				I
Bolts and nuts on chassis and body					T				T
Exhaust system and heat shields	Inspect every 72,000 km (45,000 miles) or 5 years.								
Emergency flat tire repair kit (if installed)*6	Inspect annually.								

Chart symbols:

I: Inspect: Inspect and clean, repair, adjust, fill up, or replace if necessary.

R: Replace

T: Tighten

Scheduled Maintenance

Remarks:

- *1 Use of FL-22 is recommended when replacing engine coolant. Using engine coolant other than FL-22 may cause serious damage to the engine and cooling system.
- *2 According to state/provincial and federal regulations, failure to perform maintenance on these items will not void your emissions warranties. However, Mazda recommends that all maintenance services be performed at the recommended time or mileage/kilometer period to ensure long-term reliability.
- *3 To equalize tread wear for maintaining good performance in handling and braking, rotate the tires every 12,000 km (7,500 miles). However Mazda recommends to rotate every 8,000 km (5,000 miles) to help increase tire life and distribute wear more evenly.
- *4 The Tire Pressure Monitoring System (TPMS) initialization must be performed so that the system operates normally (if equipped).
- *5 If this component has been submerged in water, the oil should be replaced.
- *6 Check the tire repair fluid expiration date every year when performing the periodic maintenance. Replace the tire repair fluid bottle with new one before the expiration date.

Scheduled Maintenance

▼ Schedule 2

U.S.A. and Puerto Rico residents - Severe driving conditions maintenance interval

Maintenance Interval	Number of months or kilometers (miles), whichever comes first.												
	Months	6	12	18	24	30	36	42	48	54	60	66	72
	×1000 km	8	16	24	32	40	48	56	64	72	80	88	96
	×1000 miles	5	10	15	20	25	30	35	40	45	50	55	60
ENGINE													
Drive belts							I						I
Engine oil & filter	Flexible*1	Replace when wrench indicator light is ON. (Max interval: 12 months/16,000 km (10,000 miles))											
	Fixed	R	R	R	R	R	R	R	R	R	R	R	R
COOLING SYSTEM													
Engine coolant*2	Replace at first 192,000 km (120,000 miles) or 10 years; after that, every 96,000 km (60,000 miles) or 5 years.												
Engine coolant level	I	I	I	I	I	I	I	I	I	I	I	I	I
FUEL SYSTEM													
Air filter*3	Replace when any equivalent timing of replacing engine oil. (Max interval: 36 months or 60,000 km (37,500 miles))												
Fuel lines and hoses*4				I				I					I
Hoses and tubes for emission*4								I					
IGNITION SYSTEM													
Spark plugs	Replace every 120,000 km (75,000 miles).												
ELECTRICAL SYSTEM													
Function of all lights	I	I	I	I	I	I	I	I	I	I	I	I	I
CHASSIS and BODY													
Brake lines, hoses and connections				I				I					I
Brake and clutch fluid level	I	I	I	I	I	I	I	I	I	I	I	I	I
Disc brakes		I		I		I		I		I		I	I
Manual transmission oil	Replace every 48,000 km (30,000 miles) or 2 years.												
Tire (Rotation)*5	Rotate when any equivalent timing of replacing engine oil. (Max interval: 8,000 km (5,000 miles))												
Tire inflation pressure and tire wear*5	I	I	I	I	I	I	I	I	I	I	I	I	I
Steering operation and linkages				I				I					I
Front and rear suspension, ball joints and wheel bearing axial play				I				I					I
Rear differential oil	*6												
Driveshaft dust boots				I				I					I
Bolts and nuts on chassis and body				T				T					T
Exhaust system and heat shields	Inspect every 72,000 km (45,000 miles) or 5 years.												

Scheduled Maintenance

Maintenance Interval	Number of months or kilometers (miles), whichever comes first.												
	Months	6	12	18	24	30	36	42	48	54	60	66	72
	×1000 km	8	16	24	32	40	48	56	64	72	80	88	96
	×1000 miles	5	10	15	20	25	30	35	40	45	50	55	60
All locks and hinges	L	L	L	L	L	L	L	L	L	L	L	L	L
Washer fluid level	I	I	I	I	I	I	I	I	I	I	I	I	I
Emergency flat tire repair kit (if installed)*7	Inspect annually.												

Chart symbols:

I: Inspect: Inspect and clean, repair, adjust, fill up, or replace if necessary.

R: Replace

L: Lubricate

T: Tighten

Remarks:

*1 Engine oil flexible maintenance is available for U.S.A. and Puerto Rico residents whose vehicle is operated mainly where none of the following conditions apply.

- Extended periods of idling or low-speed operation such as police car, taxi or driving school car
- Driving in dusty conditions

If any do apply, follow fixed maintenance.

The engine oil and filter must be changed at least once a year or within 16,000 km (10,000 miles) since last engine oil and filter change. Reset the engine oil data whenever replacing the engine oil regardless of the message/wrench indicator light display.

- *2 Use of FL-22 is recommended when replacing engine coolant. Using engine coolant other than FL-22 may cause serious damage to the engine and cooling system.
- *3 If the vehicle is operated in very dusty or sandy areas, clean and if necessary, replace the air filter more often than the recommended intervals.
- *4 According to state/provincial and federal regulations, failure to perform maintenance on these items will not void your emissions warranties. However, Mazda recommends that all maintenance services be performed at the recommended time or mileage/kilometer period to ensure long-term reliability.
- *5 The Tire Pressure Monitoring System (TPMS) initialization must be performed so that the system operates normally (if equipped).
- *6 If this component has been submerged in water, the oil should be replaced.
- *7 Check the tire repair fluid expiration date every year when performing the periodic maintenance. Replace the tire repair fluid bottle with new one before the expiration date.

Scheduled Maintenance

Canada residents

Maintenance Interval	Number of months or kilometers (miles), whichever comes first.												
	Months	6	12	18	24	30	36	42	48	54	60	66	72
	×1000 km	8	16	24	32	40	48	56	64	72	80	88	96
	×1000 miles	5	10	15	20	25	30	35	40	45	50	55	60
ENGINE													
Drive belts							I						I
Engine oil & filter	R	R	R	R	R	R	R	R	R	R	R	R	R
COOLING SYSTEM													
Engine coolant* ¹	Replace at first 192,000 km (120,000 miles) or 10 years; after that, every 96,000 km (60,000 miles) or 5 years.												
Engine coolant level	I	I	I	I	I	I	I	I	I	I	I	I	I
FUEL SYSTEM													
Air filter	I	I	I	I	I	I	I	I	I	I	I	I	I
	Replace every 56,000 km (35,000 miles) or 3 years.												
Fuel lines and hoses* ²				I					I				I
Hoses and tubes for emission* ²									I				
IGNITION SYSTEM													
Spark plugs	Replace every 120,000 km (75,000 miles).												
ELECTRICAL SYSTEM													
Function of all lights	I	I	I	I	I	I	I	I	I	I	I	I	I
CHASSIS and BODY													
Brake lines, hoses and connections				I					I				I
Brake and clutch fluid level	I	I	I	I	I	I	I	I	I	I	I	I	I
Disc brakes	Inspect every 24,000 km (15,000 miles) or 1 years.												
Manual transmission oil	Replace every 48,000 km (30,000 miles) or 2 years.												
Tire (Rotation)* ³	Rotate every 8,000 km (5,000 miles).												
Tire inflation pressure and tire wear* ³	I	I	I	I	I	I	I	I	I	I	I	I	I
Steering operation and linkages				I					I				I
Front and rear suspension, ball joints and wheel bearing axial play				I					I				I
Rear differential oil	* ⁴												
Driveshaft dust boots				I					I				I
Bolts and nuts on chassis and body				T					T				T
Exhaust system and heat shields	Inspect every 72,000 km (45,000 miles) or 5 years.												
All locks and hinges	L	L	L	L	L	L	L	L	L	L	L	L	L
Washer fluid level	I	I	I	I	I	I	I	I	I	I	I	I	I
Emergency flat tire repair kit (if installed)* ⁵	Inspect annually.												

Scheduled Maintenance

Chart symbols:

I: Inspect: Inspect and clean, repair, adjust, fill up, or replace if necessary.

R: Replace

L: Lubricate

T: Tighten

Remarks:

- *1 Use of FL-22 is recommended when replacing engine coolant. Using engine coolant other than FL-22 may cause serious damage to the engine and cooling system.
- *2 According to state/provincial and federal regulations, failure to perform maintenance on these items will not void your emissions warranties. However, Mazda recommends that all maintenance services be performed at the recommended time or mileage/kilometer period to ensure long-term reliability.
- *3 The Tire Pressure Monitoring System (TPMS) initialization must be performed so that the system operates normally (if equipped).
- *4 If this component has been submerged in water, the oil should be replaced.
- *5 Check the tire repair fluid expiration date every year when performing the periodic maintenance. Replace the tire repair fluid bottle with new one before the expiration date.

Scheduled Maintenance (Mexico)

Follow Schedule 1 if the vehicle is operated mainly where none of the following conditions (severe driving conditions) apply.

- Repeated short-distance driving
- Driving in dusty conditions
- Driving with extended use of brakes
- Driving in areas where salt or other corrosive materials are used
- Driving on rough or muddy roads
- Extended periods of idling or low-speed operation
- Driving for long periods in cold temperatures or extremely humid climates
- Driving in extremely hot conditions
- Driving in mountainous conditions continually

If any do apply, follow Schedule 2.

NOTE

For maintenance guidelines beyond the kilometers/months listed, follow the maintenance intervals provided in the Scheduled Maintenance Tables.

Scheduled Maintenance

▼ Schedule 1

Maintenance Interval	Number of months or kilometers, whichever comes first												
	Months	6	12	18	24	30	36	42	48	54	60	66	72
	×1000 km	10	20	30	40	50	60	70	80	90	100	110	120
ENGINE													
Drive belts				I					I				I
Engine oil & filter	R	R	R	R	R	R	R	R	R	R	R	R	R
COOLING SYSTEM													
Cooling system				I					I				I
Engine coolant*1	Replace at first 200,000 km or 10 years; after that, every 100,000 km or 5 years												
FUEL SYSTEM													
Air filter		R		R		R		R		R		R	
Fuel lines and hoses				I ²					I ²				I
Hoses and tubes for emission				I ²					I ²				I
Fuel filter	Replace every 60,000 km												
IGNITION SYSTEM													
Spark plugs	I	I	I	I	I	I	I	I	I	I	I	I	I
	Replace every 120,000 km												
CHASSIS and BODY													
Brake lines, hoses and connections		I		I		I		I		I		I	
Brake and clutch fluid level	I	I	I		I	I	I		I	I	I		
Brake fluid				R				R					R
Disc brakes	I	I	I	I	I	I	I	I	I	I	I	I	I
Manual transmission oil								R					
Tire (Rotation) ³	Rotate every 10,000 km												
Tire inflation pressure and tire wear ³	I	I	I	I	I	I	I	I	I	I	I	I	I
Steering operation and linkages	I	I	I	I	I	I	I	I	I	I	I	I	I
Front and rear suspension, ball joints and wheel bearing axial play		I		I		I		I		I		I	
Rear differential oil	⁴												
Driveshaft dust boots		I		I		I		I		I		I	
Bolts and nuts on chassis and body		T		T		T		T		T		T	
Exhaust system and heat shields		I		I		I		I		I		I	
All locks and hinges	L	L	L	L	L	L	L	L	L	L	L	L	L
Washer fluid level	I	I	I	I	I	I	I	I	I	I	I	I	I
Emergency flat tire repair kit (if installed) ⁵	Inspect annually.												

Scheduled Maintenance

Chart symbols:

I: Inspect: Inspect and clean, repair, adjust, fill up, or replace if necessary.

R: Replace

L: Lubricate

T: Tighten

Remarks:

- *1 Use of FL-22 is recommended when replacing engine coolant. Using engine coolant other than FL-22 may cause serious damage to the engine and cooling system.
- *2 According to state/provincial and federal regulations, failure to perform maintenance on these items will not void your emissions warranties. However, Mazda recommends that all maintenance services be performed at the recommended time or kilometer period to ensure long-term reliability.
- *3 The Tire Pressure Monitoring System (TPMS) initialization must be performed so that the system operates normally (if equipped).
- *4 If this component has been submerged in water, the oil should be replaced.
- *5 Check the tire repair fluid expiration date every year when performing the periodic maintenance. Replace the tire repair fluid bottle with new one before the expiration date.

Scheduled Maintenance

▼ Schedule 2

Maintenance Interval	Number of months or kilometers, whichever comes first												
	Months	3	6	9	12	15	18	21	24	27	30	33	36
	×1000 km	5	10	15	20	25	30	35	40	45	50	55	60
ENGINE													
Drive belts									I				
Engine oil & filter	R	R	R	R	R	R	R	R	R	R	R	R	R
COOLING SYSTEM													
Cooling system									I				
Engine coolant*1	Replace at first 200,000 km or 10 years; after that, every 100,000 km or 5 years												
Engine coolant level	I	I	I	I	I	I	I	I	I	I	I	I	I
FUEL SYSTEM													
Air filter		C		R		C		R		C		R	
Fuel lines and hoses								I ²					
Hoses and tubes for emission								I ²					
Fuel filter	Replace every 60,000 km												
IGNITION SYSTEM													
Spark plugs		I		I		I		I		I		I	
	Replace every 120,000 km												
ELECTRICAL SYSTEM													
Function of all lights	I	I	I	I	I	I	I	I	I	I	I	I	I
CHASSIS and BODY													
Brake lines, hoses and connections				I				I					I
Brake and clutch fluid level		I		I		I				I			I
Brake fluid								R					
Disc brakes		I		I		I		I		I			I
Manual transmission oil								R					
Tire (Rotation)*3	Rotate every 10,000 km												
Tire inflation pressure and tire wear*3		I		I		I		I		I			I
Steering operation and linkages		I		I		I		I		I			I
Front and rear suspension, ball joints and wheel bearing axial play				I				I					I
Rear differential oil	*4												
Driveshaft dust boots				I				I					I
Bolts and nuts on chassis and body				T				T					T
Exhaust system and heat shields				I				I					I
All locks and hinges		L		L		L		L		L			L

Scheduled Maintenance

Maintenance Interval	Number of months or kilometers, whichever comes first												
	Months	3	6	9	12	15	18	21	24	27	30	33	36
	×1000 km	5	10	15	20	25	30	35	40	45	50	55	60
Washer fluid level		I		I		I		I		I		I	
Emergency flat tire repair kit (if installed)*5	Inspect annually.												

Chart symbols:

I: Inspect: Inspect and clean, repair, adjust, fill up, or replace if necessary.

R: Replace

L: Lubricate

C: Clean

T: Tighten

Remarks:

- *1 Use of FL-22 is recommended when replacing engine coolant. Using engine coolant other than FL-22 may cause serious damage to the engine and cooling system.
- *2 According to state/provincial and federal regulations, failure to perform maintenance on these items will not void your emissions warranties. However, Mazda recommends that all maintenance services be performed at the recommended time or kilometer period to ensure long-term reliability.
- *3 The Tire Pressure Monitoring System (TPMS) initialization must be performed so that the system operates normally (if equipped).
- *4 If this component has been submerged in water, the oil should be replaced.
- *5 Check the tire repair fluid expiration date every year when performing the periodic maintenance. Replace the tire repair fluid bottle with new one before the expiration date.

Scheduled Maintenance

(Cont.)

Maintenance Interval	Number of months or kilometers, whichever comes first												
	Months	39	42	45	48	51	54	57	60	63	66	69	72
	×1000 km	65	70	75	80	85	90	95	100	105	110	115	120
ENGINE													
Drive belts				I									I
Engine oil & filter	R	R	R	R	R	R	R	R	R	R	R	R	R
COOLING SYSTEM													
Cooling system				I									I
Engine coolant*1	Replace at first 200,000 km or 10 years; after that, every 100,000 km or 5 years												
Engine coolant level	I	I	I	I	I	I	I	I	I	I	I	I	I
FUEL SYSTEM													
Air filter		C		R		C		R		C			R
Fuel lines and hoses				I ²									I
Hoses and tubes for emission				I ²									I
Fuel filter	Replace every 60,000 km												
IGNITION SYSTEM													
Spark plugs		I		I		I		I		I		I	I
	Replace every 120,000 km												
ELECTRICAL SYSTEM													
Function of all lights	I	I	I	I	I	I	I	I	I	I	I	I	I
CHASSIS and BODY													
Brake lines, hoses and connections				I				I					I
Brake and clutch fluid level		I					I	I		I			
Brake fluid				R									R
Disc brakes		I		I		I		I		I			I
Manual transmission oil				R									R
Tire (Rotation)*3	Rotate every 10,000 km												
Tire inflation pressure and tire wear*3		I		I		I		I		I		I	I
Steering operation and linkages		I		I		I		I		I			I
Front and rear suspension, ball joints and wheel bearing axial play				I				I					I
Rear differential oil	*4												
Driveshaft dust boots				I				I					I
Bolts and nuts on chassis and body				T				T					T
Exhaust system and heat shields				I				I					I
All locks and hinges		L		L		L		L		L		L	L

Scheduled Maintenance

Maintenance Interval	Number of months or kilometers, whichever comes first												
	Months	39	42	45	48	51	54	57	60	63	66	69	72
	×1000 km	65	70	75	80	85	90	95	100	105	110	115	120
Washer fluid level		I			I			I		I		I	
Emergency flat tire repair kit (if installed)*5	Inspect annually.												

Chart symbols:

I: Inspect: Inspect and clean, repair, adjust, fill up, or replace if necessary.

R: Replace

L: Lubricate

C: Clean

T: Tighten

Remarks:

- *1 Use of FL-22 is recommended when replacing engine coolant. Using engine coolant other than FL-22 may cause serious damage to the engine and cooling system.
- *2 According to state/provincial and federal regulations, failure to perform maintenance on these items will not void your emissions warranties. However, Mazda recommends that all maintenance services be performed at the recommended time or kilometer period to ensure long-term reliability.
- *3 The Tire Pressure Monitoring System (TPMS) initialization must be performed so that the system operates normally (if equipped).
- *4 If this component has been submerged in water, the oil should be replaced.
- *5 Check the tire repair fluid expiration date every year when performing the periodic maintenance. Replace the tire repair fluid bottle with new one before the expiration date.

Scheduled Maintenance

Maintenance Monitor

▼ Maintenance Monitor (Type A audio)

“Oil Change” with a flexible setting*¹ is available. Consult your Authorized Mazda Dealer when you want to change the setting*². Once the system turns on, the wrench indicator light in the instrument cluster will be illuminated when remaining oil life becomes less than 1,000 km (600 mile), or remaining days are less than 15 (whichever comes first).

Reset method

Press and hold the selector with the ignition switched off, then switch it on. Keep pressing the selector for more than 5 seconds. The master warning light will flash for a few seconds when the reset is completed.

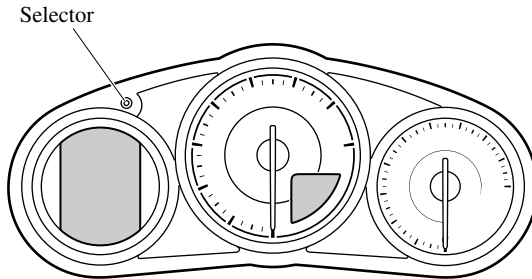

*1 The flexible setting is available in the United States and Puerto Rico. Based on the engine operating conditions, the onboard computer in your vehicle calculates the remaining oil life. Mazda Genuine 0W-20 oil and Castrol® 0W-20 oil are required to achieve optimum calculation performance.

*2 Once the Flexible Oil Maintenance Setting is selected, the system must be reset whenever replacing the engine oil.

▼ Maintenance Monitor (Type B audio)

1. Select the  icon on the home screen to display the “Applications” screen.
2. Select “Vehicle Status Monitor”.
3. Select “Maintenance” to display the maintenance list screen.
4. Switch the tab and select the setting item you want to change.

Scheduled Maintenance

You can customize settings in the setup display as follows:

Tab	Item	Explanation
Scheduled	Setting	Notification can be switched on/off.
	Time (months)	Displays the time or distance until maintenance is due. Select this item to set the maintenance period. The wrench indication/indicator light in the instrument cluster will be illuminated when the remaining distance is less than 1,000 km or 600 mile, or the remaining number of days is less than 15 (whichever comes first).
	Distance (km or mile)	
	Reset	Resets the time and distance to the initial values. Once the system turns on, it needs to be reset whenever carrying out maintenance.
Tire Rotation	Setting	Notification can be switched on/off.
	Distance (km or mile)	Displays the distance until tire rotation is due. Select this item to set the tire rotation distance. The wrench indication/indicator light in the instrument cluster will be illuminated when the remaining distance is less than 1,000 km or 600 mile.
	Reset	Resets the remaining distance to the initial value. Once the system turns on, it needs to be reset whenever rotating the tires.
Oil Change	Setting Interval	Oil replacement period can be selected from the flexible setting or fixed setting, or it can be set to non-display. The flexible setting is available only in the United States and Puerto Rico. Once engine oil flexible maintenance is selected, the vehicle calculates the remaining oil life based on the engine operating conditions. The vehicle lets you know when an oil change is due by illuminating the wrench indicator light in the instrument cluster. Mazda Genuine 0W-20 oil and Castrol® 0W-20 oil are required to achieve optimum performance.
	Distance (km or mile) (Displays only in fixed setting)	Displays the distance until the oil replacement is due. Select this item to set the oil replacement distance. The wrench indication/indicator light in the instrument cluster will be illuminated when the remaining distance is less than 1,000 km or 600 mile.
	Oil life (%) (Displays only in flexible setting)	Displays the engine oil life until the oil replacement is due. The wrench indication/indicator light in the instrument cluster will be illuminated when the remaining oil life distance is less than 1,000 km (600 mile), or remaining days are less than 15 (whichever comes first).
	Reset	In flexible setting: Resets the remaining oil life to 100%. In fixed setting: Resets the remaining distance to the initial value. Once the Flexible Oil Maintenance Setting is selected, the system must be reset whenever replacing the engine oil.

Owner Maintenance

Owner Maintenance Precautions

The owner or a qualified service technician should make these vehicle inspections at the indicated intervals to ensure safe and dependable operation.

Bring any problem to the attention of an Authorized Mazda Dealer or qualified service technician as soon as possible.

When Refueling

- Brake and clutch fluid level (page 6-31)
- Engine coolant level (page 6-29)
- Engine oil level (page 6-28)
- Washer fluid level (page 6-31)

At Least Monthly

Tire inflation pressures (page 6-41)

At Least Twice a Year (For Example, Every Spring and Fall)

You can do the following scheduled maintenance items if you have some mechanical ability and a few basic tools and if you closely follow the directions in this manual.

- Engine coolant (page 6-29)
- Engine oil (page 6-27)

Improper or incomplete service may result in problems. This section gives instructions only for items that are easy to perform.

As explained in the Introduction (page 6-2), several procedures can be done only by a qualified service technician with special tools.

Improper owner maintenance during the warranty period may affect warranty coverage. Refer to Introduction (page 6-2) for owner's responsibility in protecting your investment. For details, read the separate Mazda Warranty statement provided with the vehicle. If you are unsure about any servicing or maintenance procedure, have it done by an Authorized Mazda Dealer.

There are strict environmental laws regarding the disposal of waste oil and fluids. Please dispose of your waste properly and with due regard to the environment.

We recommend that you entrust the oil and fluid changes of your vehicle to an Authorized Mazda Dealer.

 WARNING

Do not perform maintenance work if you lack sufficient knowledge and experience or the proper tools and equipment to do the work. Have maintenance work done by a qualified technician:

Performing maintenance work on a vehicle is dangerous if not done properly. You can be seriously injured while performing some maintenance procedures.

If you must run the engine while working under the hood, make certain that you remove all jewelry (especially rings, bracelets, watches, and necklaces) and all neckties, scarves, and similar loose clothing before getting near the engine or cooling fan which may turn on unexpectedly:

Working under the hood with the engine running is dangerous. It becomes even more dangerous when you wear jewelry or loose clothing.

Either can become entangled in moving parts and result in injury.



Pull over to a safe location, then switch the ignition off and make sure the fan is not running before attempting to work near the cooling fan:

Working near the cooling fan when it is running is dangerous. The fan could continue running indefinitely even if the engine has stopped and the engine compartment temperature is high. You could be hit by the fan and seriously injured.

Do not leave items in the engine compartment:

After you have finished checking or doing servicing in the engine compartment, do not forget and leave items such as tools or rags in the engine compartment.

Tools or other items left in the engine compartment could cause engine damage or a fire leading to an unexpected accident.

Owner Maintenance

Hood

WARNING

Always check that the hood is closed and securely locked:

A hood that is not closed and securely locked is dangerous as it could fly open while the vehicle is moving and block the driver's vision which could result in a serious accident.

▼ Opening the Hood

1. With the vehicle parked, pull the release handle to unlock the hood.

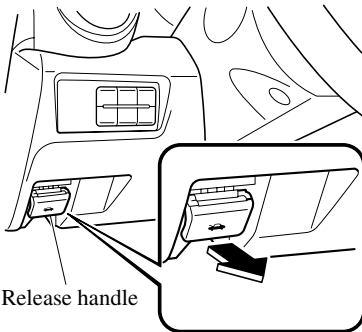

2. Insert your hand into the hood opening, slide the latch lever to the right, and lift up the hood.

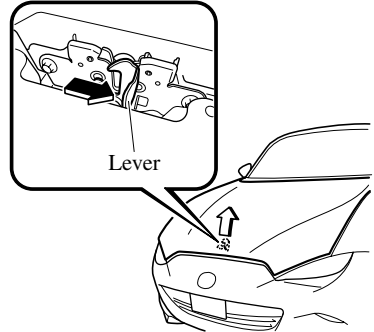

3. Grasp the support rod in the padded area and secure it in the support rod hole indicated by the arrow to hold the hood open.

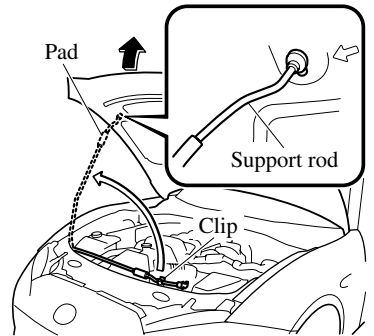

▼ Closing the Hood

1. Check under the hood area to make certain all filler caps are in place and all loose items (e.g. tools, oil containers, etc.) have been removed.
2. Lift the hood, grasp the padded area on the support rod, and secure the support rod in the clip. Verify that the support rod is secured in the clip before closing the hood.

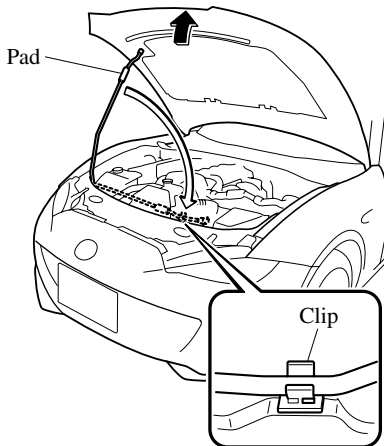

3. Lower the hood slowly to a height of about 20 cm (7.9 in) above its closed position and then let it drop.

⚠ CAUTION

When closing the hood, do not push it excessively such as by applying your weight. Otherwise, the hood could be deformed.

Engine Compartment Overview

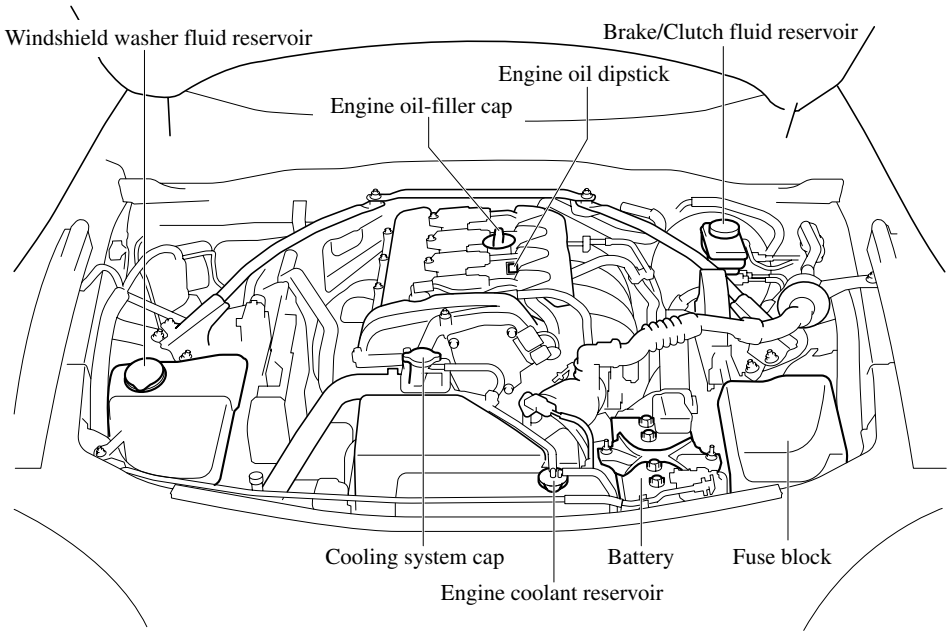

Engine Oil

NOTE

Changing the engine oil should be performed by an Authorized Mazda Dealer.

Refer to Introduction (page 6-2) for owner's responsibility in protecting your investment.

▼ Recommended Oil

U.S.A., Canada, and Puerto Rico

Use SAE 0W-20 engine oil.

Mazda Genuine Oil is used in your Mazda vehicle. Mazda Genuine 0W-20 Oil is required to achieve optimum fuel economy.

For maintenance service, Mazda recommends Mazda Genuine Parts and Castrol® (U.S.A. only).



(ILSAC)

Only use SAE 0W-20 oil “Certified For Gasoline Engines” by the American Petroleum Institute (API).

Oil with this trademark symbol conforms to the current engine and emission system protection standards and fuel economy requirements of the International Lubricant Standardization and Approval Committee (ILSAC), comprised of U.S. and Japanese automobile manufacturers.

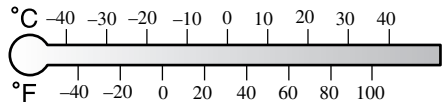

0W-20

Owner Maintenance

Except U.S.A., Canada, and Puerto Rico

Use SAE 5W-30 engine oil.

Oil container labels provide important information.

A chief contribution this type of oil makes to fuel economy is reducing the amount of fuel necessary to overcome engine friction.

For maintenance service, Mazda recommends Mazda Genuine Parts and Castrol® (Mexico only).



(ILSAC)

(Mexico)

Use SAE 5W-30 engine oil. If SAE 5W-30 engine oil is not available, use SAE 5W-20 engine oil.

The quality designation SM, or ILSAC must be on the label.

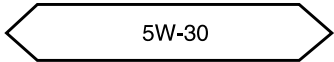
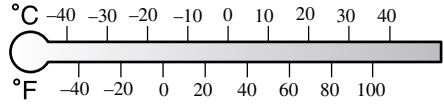

▼ Inspecting Engine Oil Level

1. Be sure the vehicle is on a level surface.
2. Warm up the engine to normal operating temperature.
3. Turn it off and wait at least 5 minutes for the oil to return to the oil pan.
4. Pull out the dipstick, wipe it clean, and reinsert it fully.

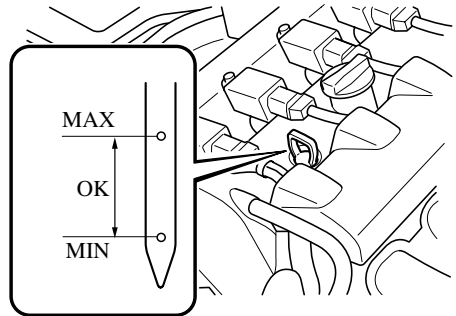

5. Pull it out again and examine the level. The level is normal if it is between the MIN and MAX marks. If it is near or below MIN, add enough oil to bring the level to MAX.

⚠ CAUTION

Do not overfill the engine oil. This may cause engine damage.

6. Make sure the O-ring on the dipstick is positioned properly before reinserting the dipstick.
7. Reinsert the dipstick fully.

Engine Coolant

▼ Inspecting Coolant Level

WARNING

Do not use a match or live flame in the engine compartment. DO NOT ADD COOLANT WHEN THE ENGINE IS HOT:

A hot engine is dangerous. If the engine has been running, parts of the engine compartment can become very hot. You could be burned. Carefully inspect the engine coolant in the coolant reservoir, but do not open it.



Pull over to a safe location, then switch the ignition off and make sure the fan is not running before attempting to work near the cooling fan:

Working near the cooling fan when it is running is dangerous. The fan could continue running indefinitely even if the engine has stopped and the engine compartment temperature is high. You could be hit by the fan and seriously injured.



Do not remove either cooling system cap when the engine and radiator are hot:

When the engine and radiator are hot, scalding coolant and steam may shoot out under pressure and cause serious injury.

NOTE

Changing the coolant should be done by an Authorized Mazda Dealer.

Owner Maintenance

Inspect the antifreeze protection and coolant level in the coolant reservoir at least once a year—at the beginning of the winter season—and before traveling where temperatures may drop below freezing.

Inspect the condition and connections of all cooling system and heater hoses. Replace any that are swollen or deteriorated.

The coolant should be at full in the radiator and between the FULL and LOW marks on the coolant reservoir when the engine is cool.

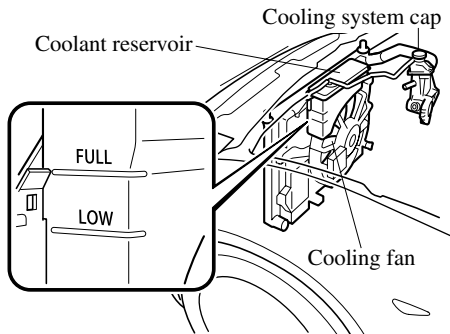



If it is at or near LOW, add enough coolant to the coolant reservoir to provide freezing and corrosion protection and to bring the level to FULL.

Securely tighten the coolant reservoir tank cap after adding coolant.

CAUTION

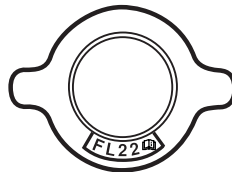
- *Radiator coolant will damage paint. Rinse it off quickly if spilled.*
- *Use only soft (demineralized) water in the coolant mixture. Water that contains minerals will cut down on the coolant's effectiveness.*
- *Do not add only water. Always add a proper coolant mixture.*
- *The engine has aluminum parts and must be protected by an ethylene-glycol-based coolant to prevent corrosion and freezing.*
- *DO NOT USE coolants Containing Alcohol, methanol, Borate or Silicate. These coolants could damage the cooling system.*
- *DO NOT MIX alcohol or methanol with the coolant. This could damage the cooling system.*
- *Do not use a solution that contains more than 60% antifreeze. This would reduce effectiveness.*
- *If the "FL22" mark is shown on or near the cooling system cap, use of FL-22 is recommended when replacing engine coolant. Using engine coolant other than FL-22 may cause serious damage to the engine and cooling system.*



FL22 

If the coolant reservoir is empty or new coolant is required frequently, consult an Authorized Mazda Dealer.

Brake/Clutch Fluid

▼ Inspecting Brake/Clutch Fluid Level

! WARNING

If the brake/clutch fluid level is low, have the brakes inspected:

A low brake/clutch fluid level is dangerous.

A low level could indicate brake lining wear or a brake system leak which could cause the brakes to fail and lead to an accident.

The brakes and clutch draw fluid from the same reservoir.

Inspect the fluid level in the reservoir regularly. It should be kept between the MAX and MIN lines.

The level normally drops with accumulated distance, a condition associated with wear of brake and clutch linings. If it is excessively low, have the brake/clutch system inspected by an Authorized Mazda Dealer.

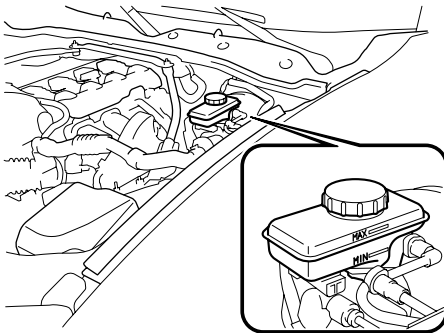

Washer Fluid

▼ Inspecting Washer Fluid Level

! WARNING

Use only windshield washer fluid or plain water in the reservoir:

Using radiator antifreeze as washer fluid is dangerous. If sprayed on the windshield, it will dirty the windshield, affect your visibility, and could result in an accident.

Using Washer Fluid Without Anti-freeze Protection in Cold Weather:

Operating your vehicle in temperatures below 4 degrees C (40 degrees F) using washer fluid without anti-freeze protection is dangerous as it could cause impaired windshield vision and result in an accident. In cold weather, always use washer fluid with anti-freeze protection.

NOTE

State or local regulations may restrict the use of volatile organic compounds (VOCs), which are commonly used as anti-freeze agents in washer fluid. A washer fluid with limited VOC content should be used only if it provides adequate freeze resistance for all regions and climates in which the vehicle will be operated.

Owner Maintenance

Inspect fluid level in the washer fluid reservoir; add fluid if necessary.

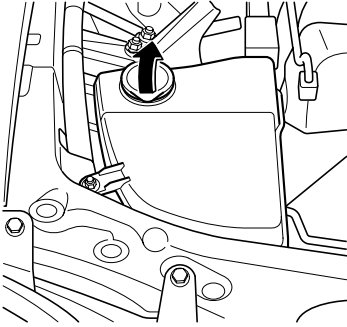

Use plain water if washer fluid is unavailable.
But use only washer fluid in cold weather to prevent it from freezing.

Body Lubrication

All moving points of the body, such as door and hood hinges and locks, should be lubricated each time the engine oil is changed. Use a nonfreezing lubricant on locks during cold weather.

Make sure the hood's secondary latch keeps the hood from opening when the primary latch is released.

Wiper Blades

⚠ CAUTION

- *Hot waxes applied by automatic car washers have been known to affect the wiper's ability to clean windows.*
- *To prevent damage to the wiper blades, do not use gasoline, kerosene, paint thinner, or other solvents on or near them.*
- *When the wiper lever is in the AUTO position and the ignition is switched ON, the wipers may move automatically in the following cases:*
 - *If the windshield above the rain sensor is touched.*
 - *If the windshield above the rain sensor is wiped with a cloth.*
 - *If the windshield is struck with a hand or other object.*
 - *If the rain sensor is struck with a hand or other object from inside the vehicle.*

Be careful not to pinch hands or fingers as it may cause injury, or damage the wipers. When washing or servicing the vehicle, make sure the wiper lever is in the OFF position.

Contamination of either the windshield or the blades with foreign matter can reduce wiper effectiveness. Common sources are insects, tree sap, and hot wax treatments used by some commercial car washes.

If the blades are not wiping properly, clean the window and blades with a good cleaner or mild detergent; then rinse thoroughly with clean water. Repeat if necessary.

▼ Replacing Windshield Wiper Blades

When the wipers no longer clean well, the blades are probably worn or cracked. Replace them.

⚠ CAUTION

To prevent damage to the wiper arms and other components, do not try to sweep the wiper arm by hand.

NOTE

When raising both windshield wiper arms, raise the driver's side wiper arm first. When lowering the wiper arms, slowly lower the wiper arm from the passenger's side first while supporting it with your hand. Forcefully lowering the wiper arms could damage the wiper arm and blade, and may scratch or crack the windshield.

(Type A)

1. Raise the wiper arm.
2. Open the clip and slide the blade assembly in the direction of the arrow.

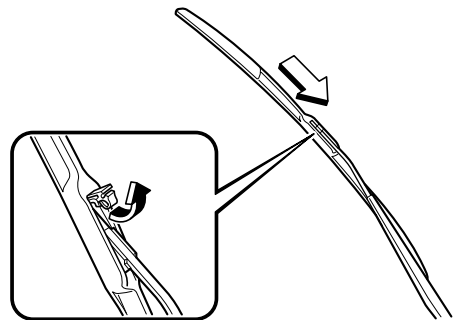

Owner Maintenance

3. Tilt the blade assembly and remove it from the arm.

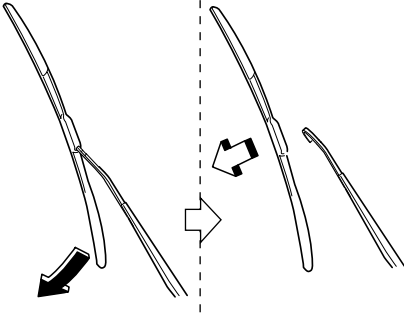

CAUTION

To prevent damage to the windshield let the wiper arm down easily, do not let it slip down on the windshield.

4. Pull down the blade rubber and slide it out of blade holder.

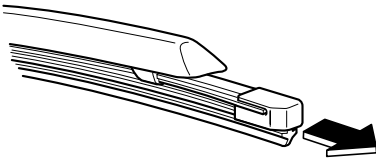

5. Remove the metal stiffeners from each blade rubber and install them in the new blade.

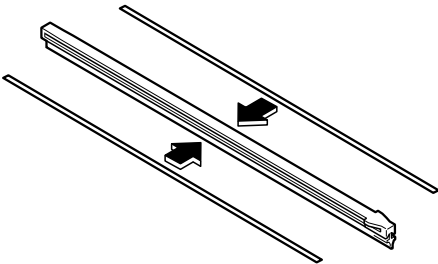

CAUTION

- Do not bend or discard the stiffeners. You need to use them again.
- If the metal stiffeners are switched, the blade's wiping efficiency could be reduced. So do not use the driver's side metal stiffeners on the passenger's side, or vice versa.
- Be sure to reinstall the metal stiffeners in the new blade rubber so that the curve is the same as it was in the old blade rubber.

6. Carefully insert the new blade rubber. Then install the blade assembly in the reverse order of removal.

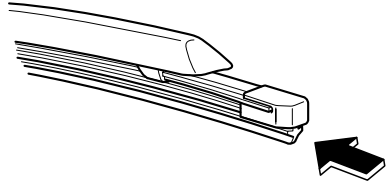

(Type B)

1. Raise the wiper arm and turn the blade assembly to expose the plastic locking clip. Compress the clip and slide the assembly downward; then lift it off the arm.

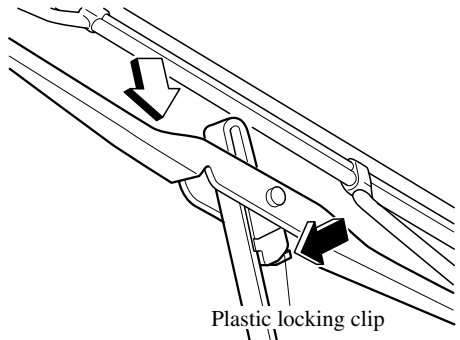

CAUTION

To prevent damage to the windshield let the wiper arm down easily, do not let it slap down on the windshield.

2. Hold the end of the rubber and pull until the tabs are free of the metal support.

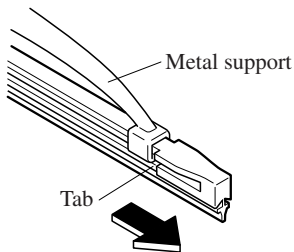

3. Remove the metal stiffeners from each blade rubber and install them in the new blade.

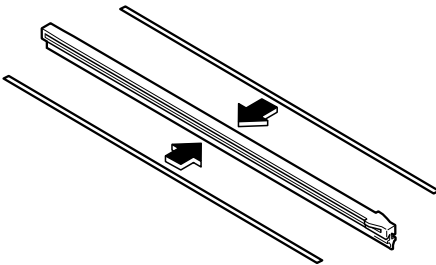

CAUTION

- > Do not bend or discard the stiffeners. You need to use them again.
- > If the metal stiffeners are switched, the blade's wiping efficiency could be reduced.
So do not use the driver's side metal stiffeners on the passenger's side, or vice versa.
- > Be sure to reinstall the metal stiffeners in the new blade rubber so that the curve is the same as it was in the old blade rubber.

4. Carefully insert the new blade rubber. Then install the blade assembly in the reverse order of removal.

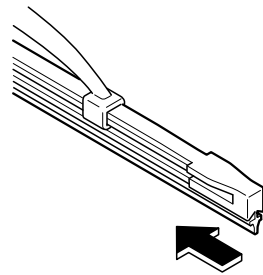

NOTE

Install the blade so that the tabs are toward the bottom of the wiper arm.

Battery

WARNING

Wash hands after handling the battery and related accessories:

Battery posts, terminals and related accessories contain lead and lead compounds, chemicals known to the State of California to cause cancer and reproductive harm.



Read the following precautions carefully before using the battery or inspecting to ensure safe and correct handling:



Always wear eye protection when working near the battery:

Working without eye protection is dangerous. Battery fluid contains SULFURIC ACID which could cause blindness if splashed into your eyes. Also, hydrogen gas produced during normal battery operation, could ignite and cause the battery to explode.



Wear eye protection and protective gloves to prevent contact with battery fluid:

Spilled battery fluid is dangerous. Battery fluid contains SULFURIC ACID which could cause serious injuries if it gets in eyes, or on the skin or clothing. If this happens, immediately flush your eyes with water for 15 minutes or wash your skin thoroughly and get medical attention.



Always keep batteries out of the reach of children:

Allowing children to play near batteries is dangerous. Battery fluid could cause serious injuries if it gets in the eyes or on the skin.



Keep flames and sparks away from open battery cells and do not allow metal tools to contact the positive (+) or negative (-) terminal of the battery when working near a battery. Do not allow the positive (+) terminal to contact the vehicle body:

Flames and sparks near open battery cells are dangerous. Hydrogen gas, produced during normal battery operation, could ignite and cause the battery to explode. An exploding battery can cause serious burns and injuries. Keep all flames including cigarettes and sparks away from open battery cells.



Keep all flames, including cigarettes, and sparks away from open battery cells:

Flames and sparks near open battery cells are dangerous. Hydrogen gas, produced during normal battery operation, could ignite and cause the battery to explode. An exploding battery can cause serious burns and injuries.

NOTE

Before performing battery maintenance, remove the battery cover.

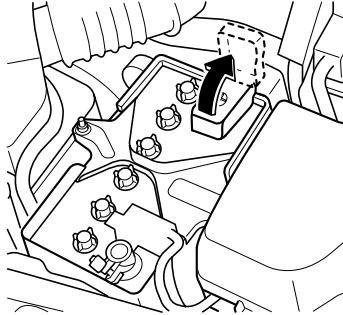

Owner Maintenance

▼ Battery Maintenance

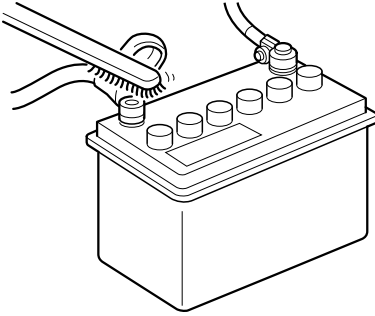

To get the best service from a battery:

- Keep it securely mounted.
- Keep the top clean and dry.
- Keep terminals and connections clean, tight, and coated with petroleum jelly or terminal grease.
- Rinse off spilled electrolyte immediately with a solution of water and baking soda.
- If the vehicle will not be used for an extended time, disconnect the battery cables and charge the battery every six weeks.

▼ Battery Replacement

Contact an Authorized Mazda Dealer for a battery replacement purchase.

Key Battery Replacement

If the buttons on the transmitter are inoperable and the operation indicator light does not flash, the battery may be dead.

Replace with a new battery before the transmitter becomes unusable.

⚠ CAUTION

- *Make sure the battery is installed correctly. Battery leakage could occur if it is not installed correctly.*
- *When replacing the battery, be careful not to touch any of the internal circuitry and electrical terminals, bend the electrical terminals, or get dirt in the transmitter as the transmitter could be damaged.*
- *There is the danger of explosion if the battery is not correctly replaced.*
- *Dispose of used batteries according to the following instructions.*
 - *Insulate the plus and minus terminals of the battery using cellophane or equivalent tape.*
 - *Never disassemble.*
 - *Never throw the battery into fire or water.*
 - *Never deform or crush.*
- *Replace only with the same type battery (CR2025 or equivalent).*

The following conditions indicate that the battery power is low:

- The KEY indicator light (green) flashes in the instrument cluster for about 30 seconds after the engine is turned off (for vehicles with a type A instrument cluster (page 4-26), messages are displayed in the instrument cluster).
- The system does not operate and the operation indicator light on the transmitter does not flash when the buttons are pressed.
- The system's operational range is reduced.

Replacing the battery at an Authorized Mazda Dealer is recommended to prevent damage to the key. If replacing the battery by yourself, follow the instruction.

Replacing the key battery

1. Press the knob and pull out the auxiliary key.

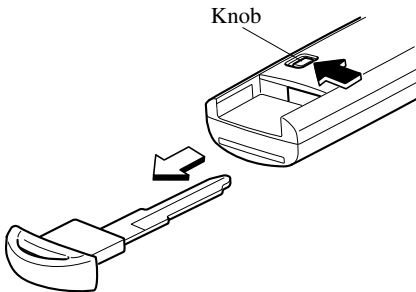

2. Twist a tape-wrapped flathead screwdriver in the direction of the arrow and open the cover slightly.

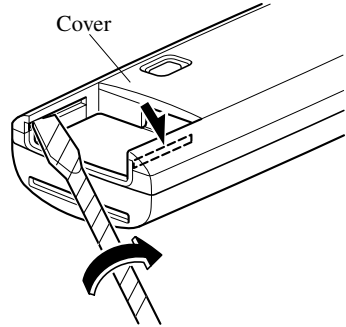

3. Insert the tape-wrapped flathead screwdriver into the gap and slide it in the direction of the arrow.

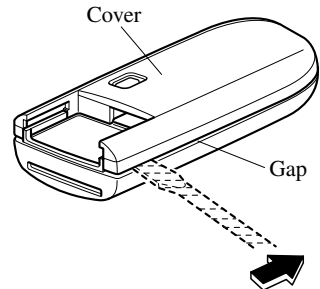

4. Twist the flathead screwdriver in the direction of the arrow and remove the cover.

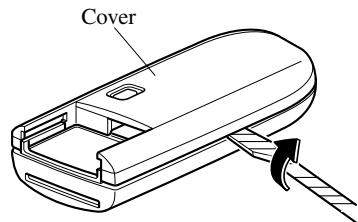

Owner Maintenance

5. Remove the battery cap, then remove the battery.

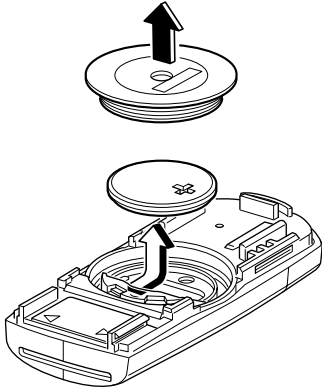

6. Insert a new battery with the positive pole facing up, and then cover the battery with the battery cap.

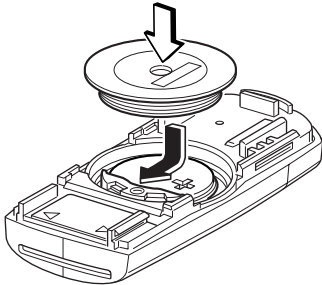

7. Close the cover.

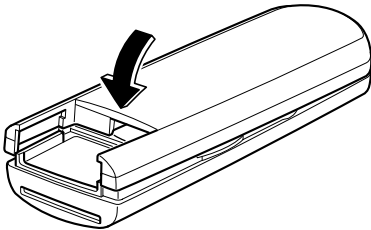

8. Reinsert the auxiliary key.

CAUTION

- Be careful not to allow the rubber ring shown in the figure to be scratched or damaged.
- If the rubber ring detaches, reattach it before inserting a new battery.

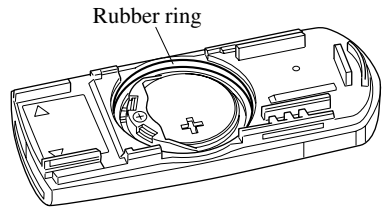

Tires

For reasons of proper performance, safety, and better fuel economy, always maintain recommended tire inflation pressures and stay within the recommended load limits and weight distribution.

WARNING

Using Different Tire Types:

Driving your vehicle with different types of tires is dangerous. It could cause poor handling and poor braking; leading to loss of control.

Except for the limited use of the temporary spare tire, use only the same type tires (radial, bias-belted, bias-type) on all four wheels.

Using Wrong-Sized Tires:

Using any other tire size than what is specified for the vehicle (page 9-8) is dangerous. It could seriously affect ride, handling, ground clearance, tire clearance, and speedometer calibration. This could cause you to have an accident. Use only tires that are the correct size specified for the vehicle.

▼ Tire Inflation Pressure

WARNING

Always inflate the tires to the correct pressure:

Overinflation or underinflation of tires is dangerous. Adverse handling or unexpected tire failure could result in a serious accident.

Refer to Tires on page 9-8.

Use only a Mazda-genuine tire valve cap:

Use of a non-genuine part is dangerous as the correct tire air pressure cannot be maintained if the tire valve becomes damaged. If the vehicle is driven under this condition, the tire air pressure will decrease which could result in a serious accident. Do not use any part for the tire valve cap that is not a Mazda-genuine part.

Inspect all tire pressures monthly when the tires are cold. Maintain recommended pressures for the best ride, handling, and minimum tire wear.

Refer to the specification charts (page 9-8).

(With tire pressure monitoring system)

After adjusting the tire pressure, initialization of the tire pressure monitoring system is necessary to make the system operate normally.

Refer to Tire Pressure Monitoring System Initialization on page 4-108.

NOTE

- *Always check tire pressure when tires are cold.*
- *Warm tires normally exceed recommended pressures. Do not release air from warm tires to adjust the pressure.*

Owner Maintenance

- *Underinflation can cause reduced fuel economy, uneven and accelerated tire wear; and poor sealing of the tire bead, which will deform the wheel and cause separation of tire from rim.*
- *Overinflation can produce a harsh ride, uneven and accelerated tire wear; and a greater possibility of damage from road hazards.*

Keep your tire pressure at the correct levels. If one frequently needs inflating, have it inspected.

▼ Tire Rotation

! WARNING

Rotate tires periodically:

Irregular tire wear is dangerous. To equalize tread wear for maintaining good performance in handling and braking, rotate the tires every 12,000 km (7,500 miles). However Mazda recommends to rotate every 8,000 km (5,000 miles) to help increase tire life and distribute wear more evenly. Refer to Scheduled Maintenance on page 6-4.

During rotation, inspect them for correct balance.

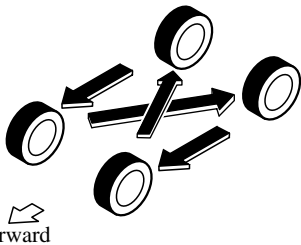

Do not include (TEMPORARY USE ONLY) spare tire in rotation.

Also, inspect them for uneven wear and damage. Abnormal wear is usually caused by one or a combination of the following:

- Incorrect tire pressure
- Improper wheel alignment
- Out-of-balance wheel
- Severe braking

After rotation, inflate all tire pressures to specification (page 9-8) and inspect the lug nuts for tightness.

(With tire pressure monitoring system)

After adjusting the tire pressure, initialization of the tire pressure monitoring system is necessary to make the system operate normally. Refer to Tire Pressure Monitoring System Initialization on page 4-108.

! CAUTION

Rotate unidirectional tires and radial tires that have an asymmetrical tread pattern or studs only from front to rear, not from side to side. Tire performance will be reduced if rotated from side to side.

(With limited-slip differential)

Do not use the following:

- *Tires not of the designated size*
- *Tires of different sizes or types at the same time*
- *Tires not sufficiently inflated*

If these instructions are not followed, the rotation of the left and right wheels will be different and will thus apply a constant load on the limited-slip differential.

This will cause a malfunction.

▼ Replacing a Tire

! WARNING

Always use tires that are in good condition:

Driving with worn tires is dangerous. Reduced braking, steering, and traction could result in an accident.

Replace all four tires at the same time:

Replacing just one tire is dangerous. It could cause poor handling and poor braking resulting in loss of vehicle control. Mazda strongly recommends that you replace all four tires at the same time.

If a tire wears evenly, a wear indicator will appear as a solid band across the tread. Replace the tire when this happens.

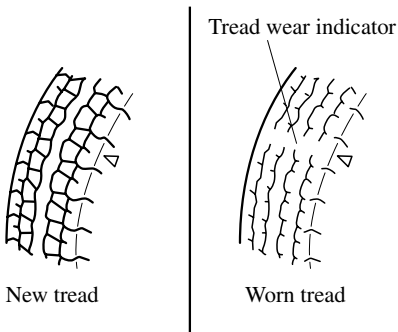

You should replace the tire before the band crosses the entire tread.

(With tire pressure monitoring system)

After adjusting the tire pressure, initialization of the tire pressure monitoring system is necessary to make the system operate normally.

Refer to Tire Pressure Monitoring System Initialization on page 4-108.

NOTE

Tires degrade over time, even when they are not being used on the road. It is recommended that tires generally be replaced when they are 6 years or older. Heat caused by hot climates or frequent high loading conditions can accelerate the aging process. The period in which the tire was manufactured (both week and year) is indicated by a 4-digit number. Refer to Tire Labeling on page 8-24.

▼ Replacing a Wheel

! WARNING

Always use wheels of the correct size on your vehicle:

Using a wrong-sized wheel is dangerous. Braking and handling could be affected, leading to loss of control and an accident.

! CAUTION

A wrong-sized wheel may adversely affect:

- Tire fit
- Wheel and bearing life
- Ground clearance
- Snow-chain clearance
- Speedometer calibration
- Headlight aim
- Bumper height
- Tire Pressure Monitoring System*

Owner Maintenance

NOTE

- *When replacing a wheel, make sure the new one is the same as the original factory wheel in diameter, rim width, and offset (inset/outset).*
- *For details, contact an Authorized Mazda Dealer.*

Proper tire balancing provides the best riding comfort and helps reduce tread wear. Out-of-balance tires can cause vibration and uneven wear, such as cupping and flat spots.

Light Bulbs

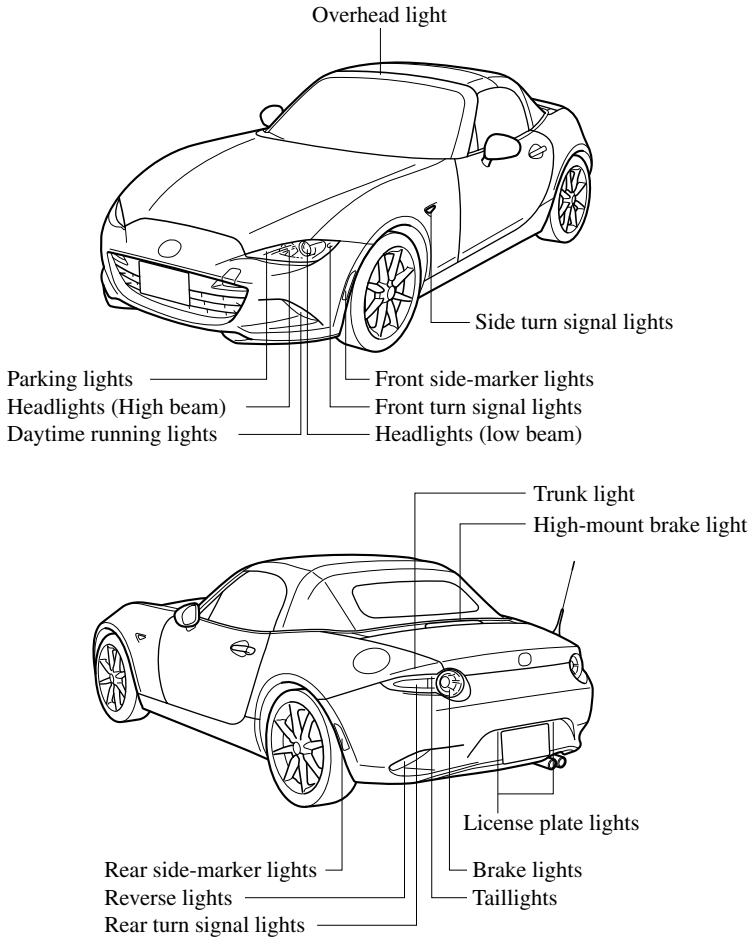

Owner Maintenance

⚠ CAUTION

When removing the lens or lamp unit using a flathead screwdriver, make sure that the flathead screwdriver does not contact the interior terminal. If the flathead screwdriver contacts the terminal, a short circuit may occur.

NOTE

- To replace the bulb, contact an Authorized Mazda Dealer.
- Use the protective cover and carton for the replacement bulb to dispose of the old bulb promptly and out of the reach of children.

▼ Replacing Exterior Light Bulbs

Headlights, Daytime running lights (LED type), Parking lights, High-mount brake light, Brake lights, Taillights

The LED bulb cannot be replaced as a single unit because it is an integrated unit. The LED bulb has to be replaced with the unit. We recommend an Authorized Mazda Dealer when the replacement is necessary.

Daytime running lights (Bulb type)

1. Make sure the ignition is switched off, and the headlight switch is off.
2. Pull the center of each plastic retainer and remove the retainers.

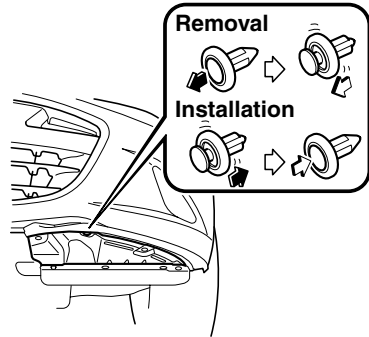

3. Turn the screw counterclockwise and remove it, and then partially peel back the mudguard.

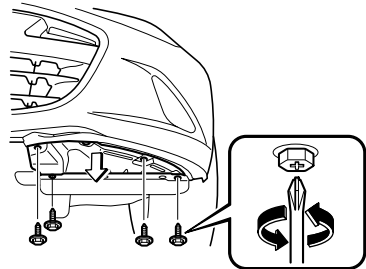

4. Turn the socket and bulb assembly counterclockwise and remove it.

5. Disconnect the bulb from the socket.

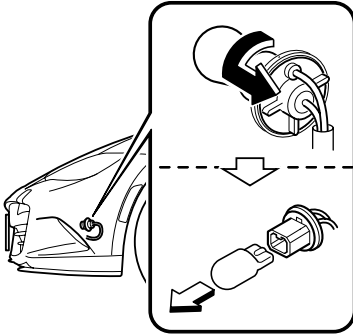

6. Install the new bulb in the reverse order of the removal procedure.

Front side-marker lights

1. Make sure the ignition is switched off, and the headlight switch is off.
2. If you are changing the right bulb, start the engine, turn the steering wheel all the way to the right, and turn off engine. If you are changing the left bulb, turn the steering wheel to the left.
3. Pull the center of each plastic retainer and remove the retainers, and then partially peel back the mudguard.

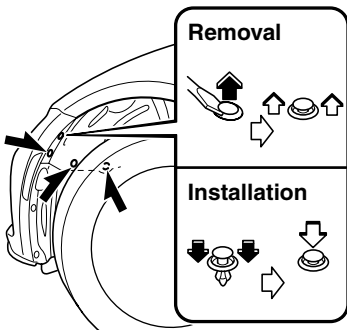

4. Turn the socket and bulb assembly counterclockwise and remove it.

5. Disconnect the bulb from the socket.

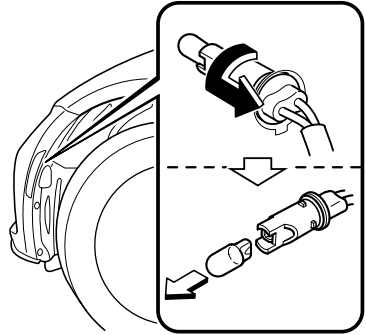

6. Install the new bulb in the reverse order of the removal procedure.

Front turn signal lights

1. Make sure the ignition is switched off, and the headlight switch is off.
2. If you are changing the right bulb, start the engine, turn the steering wheel all the way to the right, and turn off engine. If you are changing the left bulb, turn the steering wheel to the left.
3. Pull the center of each plastic retainer and remove the retainers, and then partially peel back the mudguard.

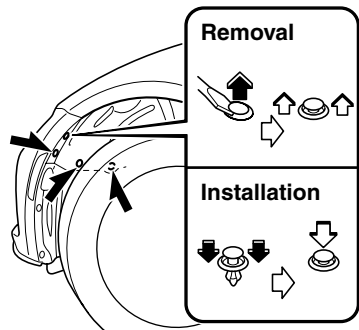

Owner Maintenance

4. Disconnect the connector from the unit by pressing the tab on the connector with your finger and pulling the connector rearward.

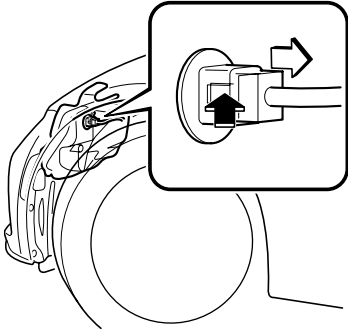

5. Turn the socket and bulb assembly counterclockwise and remove it.
6. Disconnect the bulb from the socket.

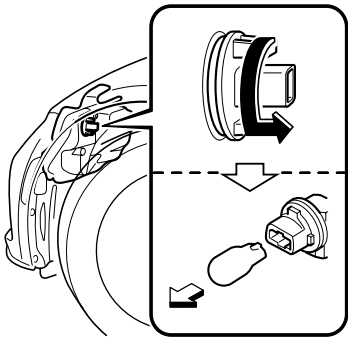

7. Install the new bulb in the reverse order of the removal procedure.

Side turn signal lights

1. Make sure the ignition is switched off, and the headlight switch is off.
2. If you are changing the right bulb, start the engine, turn the steering wheel all the way to the right, and turn off engine. If you are changing the left bulb, turn the steering wheel to the left.

3. Pull the center of each plastic retainer and remove the retainers, and then partially peel back the mudguard.

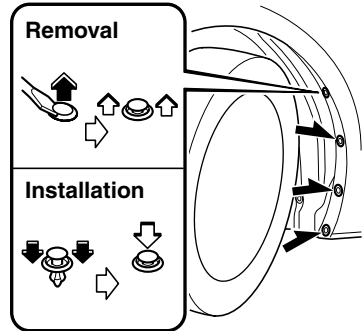

4. Remove the unit by pressing the tab on the unit with your finger and pulling the unit forward.

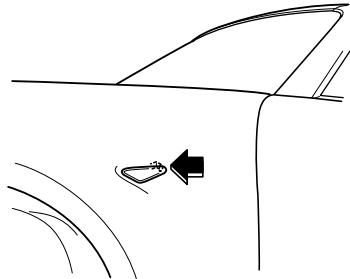

5. Detach the electrical connector from the unit by pulling it to the rear.

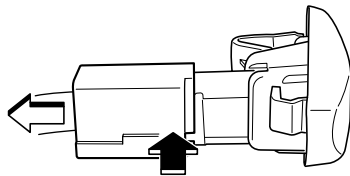

6. Install the new side turn signal unit in the reverse order of the removal procedure.

Rear turn signal lights

1. Make sure the ignition is switched off, and the headlight switch is off.
2. Pull the center of each plastic retainer and remove the retainers and the trunk side trim.

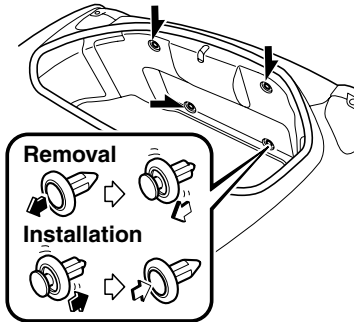

3. Disconnect the connector from the unit by pressing the tab on the connector with your finger and pulling the connector downward.

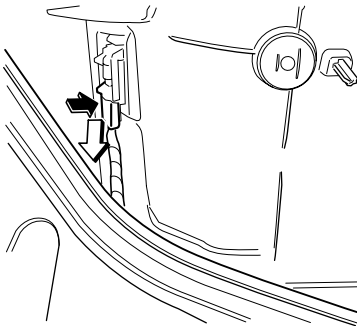

4. Pull the center of each plastic retainer and remove the retainers, and then partially peel back the trunk side trim.

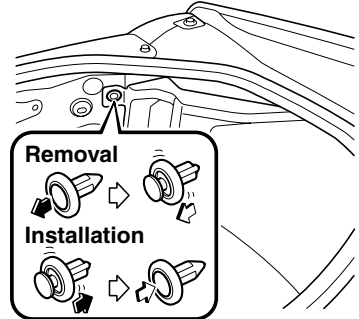

Owner Maintenance

5. To provide a hole for inserting a finger to remove the rear combination lamp unit later in the procedure, pinch the top and bottom of the grommet shown in the figure and press it out of the hole in the direction of the rear combination lamp unit.

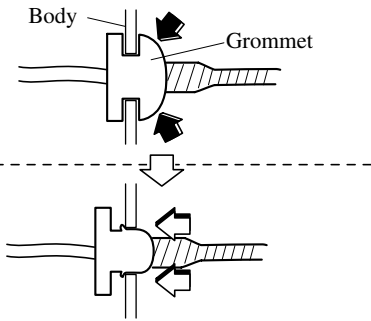
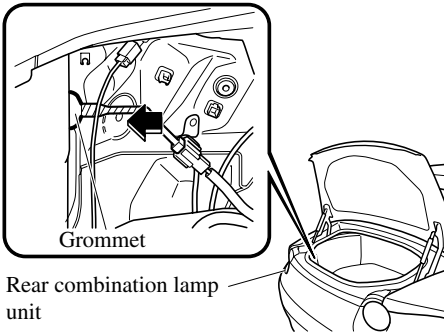

6. Apply protective tape as shown in the figure. Otherwise, the rear combination lamp unit will contact the body and may scratch or damage it. Always apply three layers of protective tape to the area indicated in the figure.

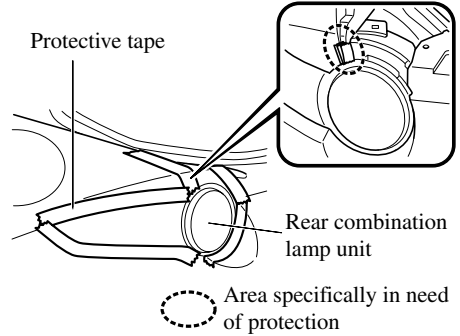

CAUTION

- Do not use tape with strong adhesive strength. Otherwise, the vehicle paint may peel off.
- Always apply three layers of protective tape to the area indicated in the figure. Otherwise, the body may become scratched or damaged when pulling out the rear combination lamp unit.

7. Remove the screw and nut.

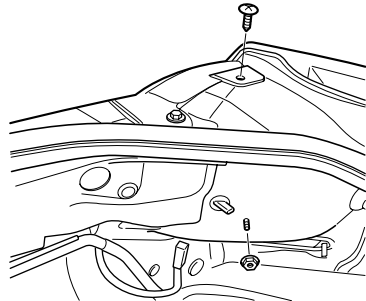

8. To remove the rear combination lamp unit, insert your finger from inside the trunk and into the hole from which the grommet was removed in Step 5, and while holding the lamp lens (round part) of the rear combination lamp with your hand, press the rear combination lamp unit until the hook detaches from the clip.

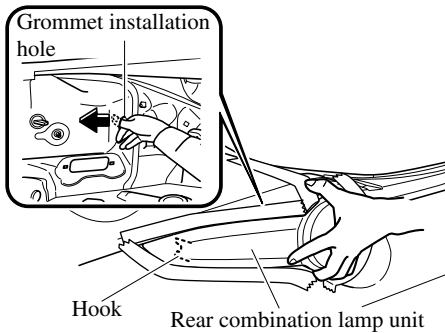

9. After the hook is detached, pull out the rear combination lamp unit in the direction of the arrow and remove it.

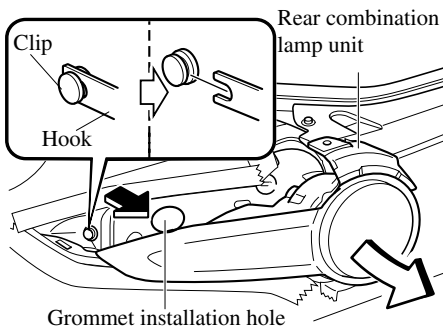

⚠ CAUTION

Carefully pull out the rear combination lamp unit when removing it from the body.

The wiring may become damaged if the rear combination lamp unit is forcefully pulled out.

10. Turn the socket and bulb assembly counterclockwise and remove it.
11. Disconnect the bulb from the socket.

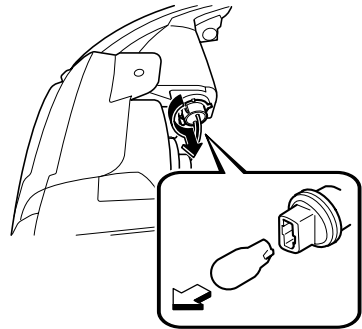

12. Install the new bulb in the reverse order of the removal procedure.

Owner Maintenance

Rear side-marker lights

1. Make sure the ignition is switched off, and the headlight switch is off.
2. Turn the socket and bulb assembly counterclockwise and remove it.
3. Disconnect the bulb from the socket.

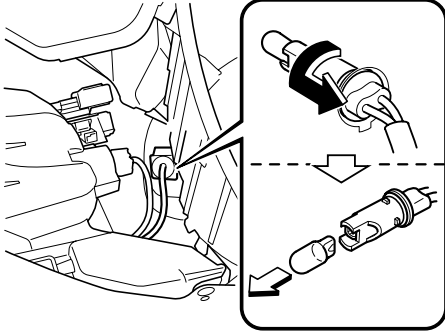

4. Install the new bulb in the reverse order of the removal procedure.

Reverse lights

1. Make sure the ignition is switched off, and the headlight switch is off.
2. Turn the socket and bulb assembly counterclockwise and remove it.
3. Disconnect the bulb from the socket.

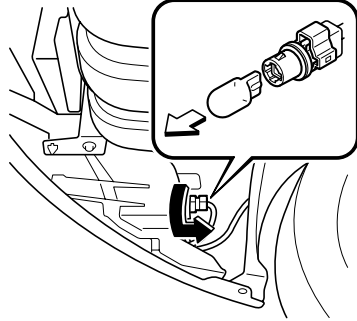

4. Install the new bulb in the reverse order of the removal procedure.

License plate lights

1. Make sure the ignition is switched off, and the headlight switch is off.
2. Remove the unit by pressing the tab on the unit with your finger and pulling the unit downward.

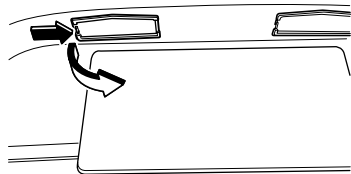

3. Turn the socket and bulb assembly counterclockwise and remove it.

4. Disconnect the bulb from the socket.

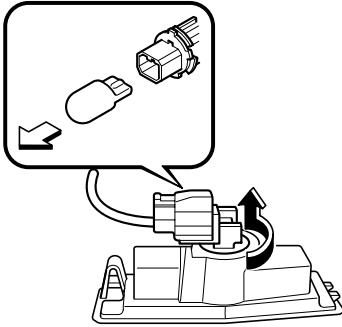

5. Install the new bulb in the reverse order of the removal procedure.

▼ Replacing Interior Light Bulbs

Overhead light

1. Wrap a small flathead screwdriver with a soft cloth to prevent damage to the lens, and then remove the lens by carefully prying on the edge of the lens with the flathead screwdriver.
2. Disconnect the bulb by pulling it out.

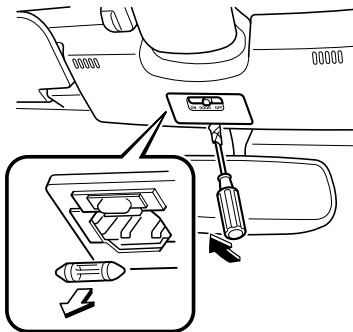

3. Install the new bulb in the reverse order of the removal procedure.

Trunk light

1. Wrap a small flathead screwdriver with a soft cloth to prevent damage to the lens, and then remove the lens by carefully prying on the edge of the lens with the flathead screwdriver.

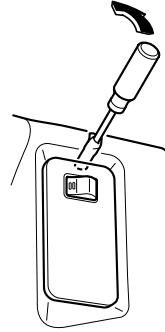

2. Disconnect the connector from the unit.
3. Disconnect the bulb by pulling it out.

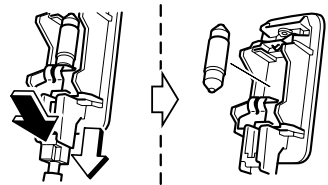

4. Install the new bulb in the reverse order of the removal procedure.

Owner Maintenance

Fuses

Your vehicle's electrical system is protected by fuses.

If any lights, accessories, or controls do not work, inspect the appropriate circuit protector. If a fuse has blown, the inside element will be melted.

If the same fuse blows again, avoid using that system and consult an Authorized Mazda Dealer as soon as possible.

▼ Fuse Replacement

Replacing the fuses on the vehicle's left side

If the electrical system does not work, first inspect the fuses on the vehicle's left side.

1. Make sure the ignition is switched off, and other switches are off.
2. Open the fuse panel cover.

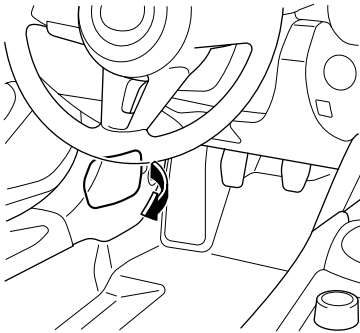

3. Pull the fuse straight out with the fuse puller provided on the fuse block located in the engine compartment.

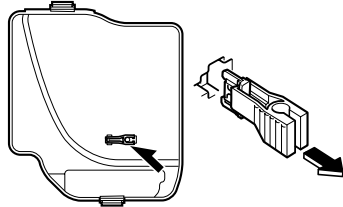

4. Inspect the fuse and replace it if it is blown.

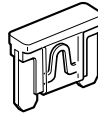

Normal

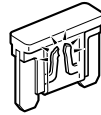

Blown

5. Insert a new fuse of the same amperage rating, and make sure it fits tightly. If it does not fit tightly, have an expert install it. We recommend an Authorized Mazda Dealer.

If you have no spare fuses, borrow one of the same rating from a circuit not essential to vehicle operation, such as the AUDIO or OUTLET circuit.

⚠ CAUTION

Always replace a fuse with a genuine Mazda fuse or equivalent of the same rating. Otherwise you may damage the electric system.

6. Reinstall the cover and make sure that it is securely installed.

Replacing the fuses under the hood

If the headlights or other electrical components do not work and the fuses in the cabin are normal, inspect the fuse block under the hood. If a fuse is blown, it must be replaced. Follow these steps:

1. Make sure the ignition is switched off, and other switches are off.
2. Remove the fuse block cover.

NOTE

If the lock is forcefully opened, the fuse block cover may come in contact with the frame when it is removed and become scratched.

When removing the cover, remove it slowly according to the following procedure.

1. Disengage the rear lock by pressing down on the front tab with your fingers.
2. Remove the front tab while slightly lifting the front of the cover.

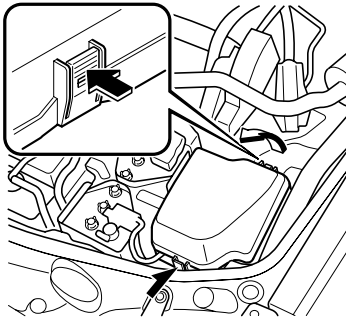

3. Remove the cover while lifting it and sliding it to the rear.

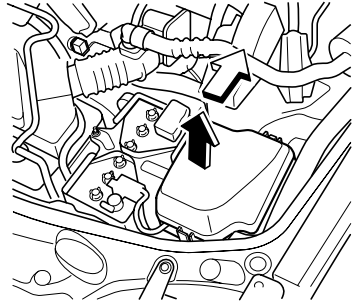

3. If any fuse but the MAIN fuse is blown, replace it with a new one of the same amperage rating.

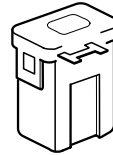

Normal



Blown

⚠ WARNING

Do not replace the main fuse and multiplex slow blow fuse by yourself. Have an Authorized Mazda Dealer perform the replacement:

Replacing these fuses by yourself is dangerous because they are high current fuses. Incorrect replacement could cause an electrical shock or a short circuit resulting in a fire.

4. Reinstall the cover and make sure that it is securely installed.

Owner Maintenance

▼ Fuse Panel Description

Fuse block (Engine compartment)

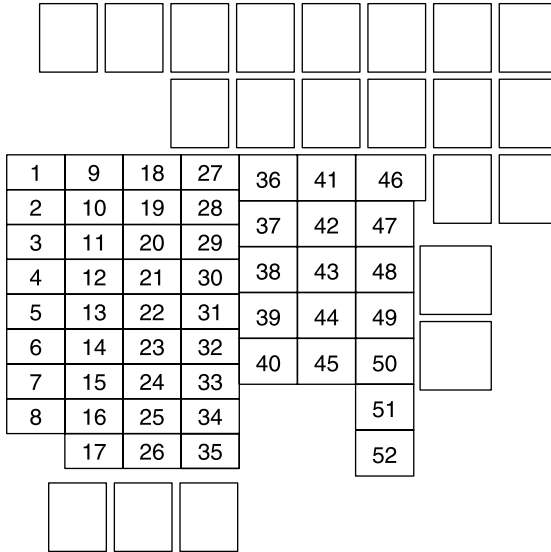

DESCRIPTION		FUSE RATING	PROTECTED COMPONENT
1	ENG IG3	5 A	—
2	ENG IG2	5 A	—
3	HORN2	7.5 A	Horn
4	C/U IG1	15 A	For protection of various circuits
5	ENG IG1	7.5 A	Engine control system
6	—	—	—
7	INTERIOR	15 A	Overhead light
8	ENG+B	7.5 A	Engine control system
9	AUDIO2	15 A	Audio system
10	METER1	10 A	Instrument cluster
11	SRS1	7.5 A	Air bag
12	—	—	—
13	RADIO	7.5 A	Audio system
14	ENGINE3	20 A	Engine control system
15	ENGINE1	10 A	Engine control system
16	ENGINE2	15 A	Engine control system
17	AUDIO1	25 A	Audio system

Owner Maintenance

DESCRIPTION		FUSE RATING	PROTECTED COMPONENT
18	A/C MAG	7.5 A	Air conditioner
19	AT PUMP H/L HI	20 A	Transmission control system*
20	AT	15 A	Transmission control system*
21	D LOCK	25 A	Power door locks
22	H/L RH	20 A	Headlight (RH)
23	ENG+B2	7.5 A	Engine control system
24	TAIL	20 A	Taillights, License plate lights, Parking lights
25	DRL	15 A	—
26	ROOM	25 A	Overhead light
27	FOG	15 A	—
28	H/CLEAN	20 A	—
29	STOP	10 A	Brake lights
30	HORN	15 A	Horn
31	H/L LH	20 A	Headlight (LH)
32	ABS/DSC S	30 A	ABS, Dynamic stability control system
33	HAZARD	15 A	Hazard warning flashers, Turn signal lights
34	FUEL PUMP	15 A	Fuel system
35	ENG+B3	5 A	—
36	WIPER	20 A	Windshield wipers
37	CABIN+B	50 A	For protection of various circuits
38	—	—	—
39	—	—	—
40	ABS/DSC M	50 A	ABS, Dynamic stability control system
41	EVVT A/R PUMP	20 A	Engine control system
42	EVPS	30 A	Brake control system
43	FAN1	30 A	Cooling fan
44	FAN2	40 A	—
45	ENG.MAIN	40 A	Engine control system
46	EPS	60 A	Power steering system
47	DEFOG	30 A	Rear window defogger
48	IG2	30 A	For protection of various circuits
49	INJECTOR	30 A	Engine control system
50	HEATER	40 A	Air conditioner
51	—	—	—
52	—	—	—

Owner Maintenance

Fuse block (Left side)

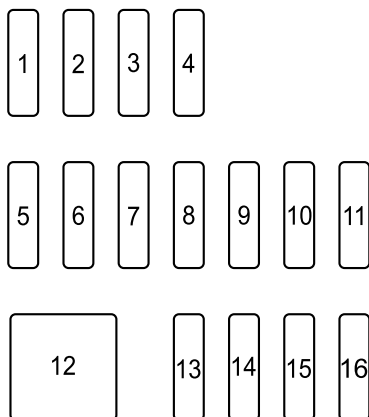

	DESCRIPTION	FUSE RATING	PROTECTED COMPONENT
1	RHT R	30 A	Retractable fastback (RH)*
2	RHT L	30 A	Retractable fastback (LH)*
3	—	—	—
4	—	—	—
5	F.OUTLET	15 A	Accessory sockets
6	—	—	—
7	AT IND	7.5 A	AT shift indicator*
8	MIRROR	7.5 A	Power control mirror
9	R_DECK R	30 A	Retractable fastback (RH)*
10	R_DECK L	30 A	Retractable fastback (LH)*
11	F.WASHER	15 A	Windshield washer
12	P.WINDOW	30 A	Power windows
13	—	—	—
14	SRS2/ESCL	15 A	—
15	SEAT WARM	20 A	Seat warmer*
16	M.DEF	7.5 A	Mirror defogger*

Exterior Care

The paintwork on your Mazda represents the latest technical developments in composition and methods of application.

Environmental hazards, however, can harm the paint's protective properties, if proper care is not taken.

Here are some examples of possible damage, with tips on how to prevent them.

Etching Caused by Acid Rain or Industrial Fallout

Occurrence

Industrial pollutants and vehicle emissions drift into the air and mix with rain or dew to form acids. These acids can settle on a vehicle's finish. As the water evaporates, the acid becomes concentrated and can damage the finish.

And the longer the acid remains on the surface, the greater the chance is for damage.

Prevention

It is necessary to wash and wax your vehicle to preserve its finish according to the instructions in this section. These steps should be taken immediately after you suspect that acid rain has settled on your vehicle's finish.

Damage Caused by Bird Dropping, Insects, or Tree Sap

Occurrence

Bird droppings contain acids. If these are not removed they can eat away the clear and color base coat of the vehicle's paintwork.

When insects stick to the paint surface and decompose, corrosive compounds form. These can erode the clear and color base coat of the vehicle's paintwork if they are not removed.

Tree sap will harden and adhere permanently to the paint finish. If you scratch the sap off while it is hard, some vehicle paint could come off with it.

Prevention

It is necessary to have your Mazda washed and waxed to preserve its finish according to the instructions in this section. This should be done as soon as possible.

Bird droppings can be removed with a soft sponge and water. If you are traveling and these are not available, a moistened tissue may also take care of the problem. The cleaned area should be waxed according to the instructions in this section.

Insects and tree sap are best removed with a soft sponge and water or a commercially available chemical cleaner.

Another method is to cover the affected area with dampened newspaper for one to two hours. After removing the newspaper, rinse off the loosened debris with water.

Appearance Care

Water Marks

Occurrence

Rain, fog, dew, and even tap water can contain harmful minerals such as salt and lime. If moisture containing these minerals settles on the vehicle and evaporates, the minerals will concentrate and harden to form white rings. The rings can damage your vehicle's finish.

Prevention

It is necessary to wash and wax your vehicle to preserve its finish according to the instructions in this section. These steps should be taken immediately after you find water marks on your vehicle's finish.

Paint Chipping

Occurrence

Paint chipping occurs when gravel thrown in the air by another vehicle's tires hits your vehicle.

How to avoid paint chipping

Keeping a safe distance between you and the vehicle ahead reduces the chances of having your paint chipped by flying gravel.

NOTE

- *The paint chipping zone varies with the speed of the vehicle. For example, when traveling at 90 km/h (56 mph), the paint chipping zone is 50 m (164 ft).*
- *In low temperatures a vehicle's finish hardens. This increases the chance of paint chipping.*
- *Chipped paint can lead to rust forming on your Mazda. Before this happens, repair the damage by using Mazda touch-up paint according to the instructions in this section. Failure to repair the affected area could lead to serious rusting and expensive repairs.*

Follow **all** label and container directions when using a chemical cleaner or polish. Read all warnings and cautions.

▼ Maintaining the Finish

Washing



- *When the wiper lever is in the **AUTO** position and the ignition is switched ON, the wipers may move automatically in the following cases:*
 - *If the windshield above the rain sensor is touched or wiped with a cloth.*
 - *If the windshield is struck with a hand or other object from either outside or inside the vehicle.*

*Keep hands and scrapers clear of the windshield when the wiper lever is in the **AUTO** position and the ignition is switched ON as fingers could be pinched or the wipers and wiper blades damaged when the wipers activate automatically. If you are going to clean the windshield, be sure the wipers are turned off completely (when it is most likely that the engine is left running) this is particularly important when clearing ice and snow.*

- *Do not spray water in the engine compartment. Otherwise, it could result in engine-starting problems or damage to electrical parts.*
- *When washing and waxing the vehicle, be careful not to apply excessive force to any single area of the vehicle hood. Otherwise, you could dent the vehicle.*

- *Do not use automatic car washing machines and car washing devices using high water pressure.*
- *Make sure that the fuel lid is closed and lock the doors. Otherwise, the fuel lid may be forcefully opened by water pressure causing damage to the vehicle or fuel lid.*

To help protect the finish from rust and deterioration, wash your Mazda thoroughly and frequently, at least once a month, with lukewarm or cold water.

If the vehicle is washed improperly, the paint surface could be scratched. Here are some examples of how scratching could occur.

Scratches occur on the paint surface when:

- The vehicle is washed without first rinsing off dirt and other foreign matter.
- The vehicle is washed with a rough, dry, or dirty cloth.
- The vehicle is washed at a car wash that uses brushes that are dirty or too stiff.
- Cleansers or wax containing abrasives are used.

NOTE

- *Mazda is not responsible for scratches caused by automatic car washes or improper washing.*
- *Scratches are more noticeable on vehicles with darker paint finishes.*

Appearance Care

To minimize scratches on the vehicle's paint finish:

- Rinse off any dirt or other foreign matter using lukewarm or cold water before washing.
- Use plenty of lukewarm or cold water and a soft cloth when washing the vehicle. Do not use a nylon cloth.
- Rub gently when washing or drying the vehicle.
- Take your vehicle only to a car wash that keeps its brushes well maintained.
- Do not use abrasive cleansers or wax that contain abrasives.

CAUTION

Do not use steel wool, abrasive cleaners, or strong detergents containing highly alkaline or caustic agents on chrome-plated or anodized aluminum parts. This may damage the protective coating; also, cleaners and detergents may discolor or deteriorate the paint.

Pay special attention to removing salt, dirt, mud, and other foreign material from the underside of the fenders, and make sure the drain holes in the lower edges of the doors and rocker panels are clean.

Insects, tar, tree sap, bird droppings, industrial fallout, and similar deposits can damage the finish if not removed immediately. When prompt washing with plain water is ineffective, use a mild soap made for use on vehicles.

Thoroughly rinse off all soap with lukewarm or cold water. Do not allow soap to dry on the finish.

After washing the vehicle, dry it with a clean chamois to prevent water spots from forming.

WARNING

Dry off brakes that have become wet by driving slowly, releasing the accelerator pedal and lightly applying the brakes several times until the brake performance returns to normal:

Driving with wet brakes is dangerous. Increased stopping distance or the vehicle pulling to one side when braking could result in a serious accident. Light braking will indicate whether the brakes have been affected.

Waxing

Your vehicle needs to be waxed when water no longer beads on the finish. Always wash and dry the vehicle before waxing it. In addition to the vehicle body, wax the metal trim to maintain its luster.

1. Use wax which contains no abrasives. Waxes containing abrasive will remove paint and could damage bright metal parts.
2. Use a good grade of natural wax for metallic, mica, and solid colors.
3. When waxing, coat evenly with the sponge supplied or a soft cloth.
4. Wipe off the wax with a soft cloth.

NOTE

A spot remover to remove oil, tar, and similar materials will usually also take off the wax. Rewax these areas even if the rest of the vehicle does not need it.

▼ Repairing Damage to the Finish

Deep scratches or chips on the finish should be repaired promptly. Exposed metal quickly rusts and can lead to major repairs.

CAUTION

If your Mazda is damaged and needs metal parts repaired or replaced, make sure the body shop applies anti-corrosion materials to all parts, both repaired and new. This will prevent them from rusting.

▼ Bright-Metal Maintenance

- Use tar remover to remove road tar and insects. Never do this with a knife or similar tool.
- To prevent corrosion on bright-metal surfaces, apply wax or chrome preservative and rub it to a high luster.
- During cold weather or in coastal areas, cover bright-metal parts with a coating of wax or preservative heavier than usual. It would also help to coat them with noncorrosive petroleum jelly or some other protective compound.

CAUTION

Do not use steel wool, abrasive cleaners, or strong detergents containing highly alkaline or caustic agents on chrome-plated or anodized aluminum parts. This may result in damage to the protective coating and cause discoloration or paint deterioration.

▼ Underbody Maintenance

Road chemicals and salt used for ice and snow removal and solvents used for dust control may collect on the underbody. If not removed, they will speed up rusting and deterioration of such underbody parts as fuel lines, frame, floor pan, and exhaust system, even though these parts may be coated with anti-corrosive material.

Thoroughly flush the underbody and wheel housings with lukewarm or cold water at the end of each winter. Try also to do this every month.

Pay special attention to these areas because they easily hide mud and dirt.

It will do more harm than good to wet down the road grime without removing it.

The lower edges of doors, rocker panels, and frame members have drain holes that should not be clogged. Water trapped there will cause rusting.

WARNING

Dry off brakes that have become wet by driving slowly, releasing the accelerator pedal and lightly applying the brakes several times until the brake performance returns to normal:

Driving with wet brakes is dangerous. Increased stopping distance or the vehicle pulling to one side when braking could result in a serious accident. Light braking will indicate whether the brakes have been affected.

Appearance Care

▼ Aluminum Wheel Maintenance

A protective coating is provided over the aluminum wheels. Special care is needed to protect this coating.

! CAUTION

Do not use any detergent other than mild detergent. Before using any detergent, verify the ingredients. Otherwise, the product could discolor or stain the aluminum wheels.

NOTE

- *Do not use a wire brush or any abrasive cleaner, polishing compound, or solvent on aluminum wheels. They may damage the coating.*
- *Always use a sponge or soft cloth to clean the wheels.*

Rinse the wheels thoroughly with lukewarm or cold water. Also, be sure to clean the wheels after driving on dusty or salted roads to help prevent corrosion.

▼ Convertible Top (Soft Top) Maintenance

The convertible top is made of a special high-grade material, but if it's not taken good care of, hardening, staining, and loss of luster will result. Maintain it under these guidelines.

Washing

Do not wait until the convertible top gets really dirty before cleaning it. Dirt that's there too long will cause deterioration.

1. Before washing, remove dust and coarse particulate with a soft brush.
2. Gently clean the convertible top with a synthetic neutral detergent, lots of water, and a soft brush.

3. Rinse it thoroughly with clean water to remove all the soap.
4. Wipe it as dry as you can before the water dries on it.
5. Then allow it to dry completely before lowering it.

! CAUTION

- *Automatic and high-pressure car washes are harmful to a convertible top. Avoid them.*
- *Do not spray water directly on the area where the window glass and the convertible top meet. This would probably cause water to enter the cabin.*
- *Do not spray water directly on the seam area of the body and the convertible top as it could result in water penetrating the cabin and trunk.*

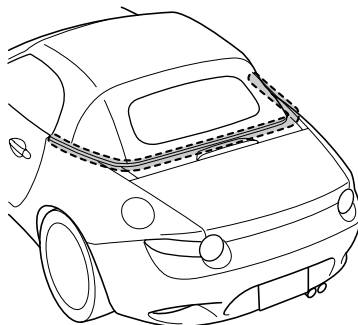

- *Some leather treatment products can ruin the convertible top's gloss. Be careful of the one you choose.*
- *Test on an inconspicuous, small corner of the convertible top if you are not sure.*
- *Do not wipe the convertible top using alcohol, chlorine bleach, or organic solvents such as thinner, benzene, or gasoline. Otherwise, they may cause discoloration or stains.*

- Do not get any car wax on the convertible top. If you do, remove it with a good leather cleaner or mild detergent (about 5% solution).
- Too much treatment on the convertible top can be as damaging as too little. Follow the manufacturer's directions. Do not overdo it!
- Let the convertible top dry completely before lowering after applying treatment or dressing.

Drain filter cleaning procedure

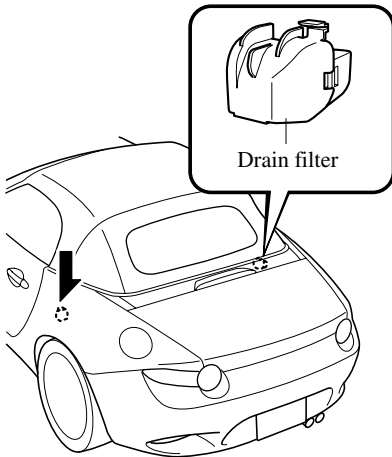

NOTE

If leaves or other matter block the drain filter, water may enter the vehicle.
Clean the drain filter at least once a year.

1. Check the position of the drain filter with your hand from behind the bow.

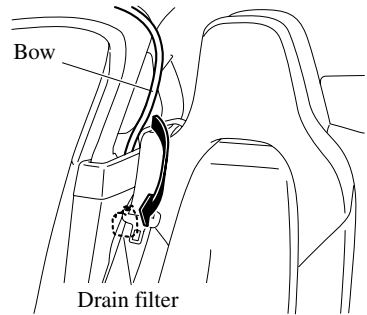

2. Remove the drain filter while pressing the tab.

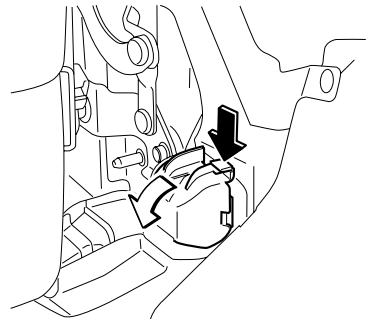

3. Remove leaves and other matter accumulated in the drain filter.
4. Reinstall the drain filter in the reverse order of the removal procedure.

CAUTION

When installing the drain filter, make sure that the drain filter is securely attached to its designated position by pushing it until the tab locks. Water may enter the vehicle if the drain filter is not secured to its designated position.

Appearance Care

▼ Convertible Top (Retractable Fastback) Maintenance

Washing

To help protect the retractable fastback's finish, use a soft cloth or sponge to wash it.

Insects, tar, tree sap, bird droppings, industrial fallout, and similar deposits can damage the finish if they are not removed immediately. When prompt washing with plain water is ineffective use a mild soap made for use on vehicles.

CAUTION

- Do not use an automatic car wash.
- Do not spray water directly on the area where the window glass and the retractable fastback meet. This would probably cause water to enter the cabin.
- Do not use strong soap, chemical detergents, or hot water, and do not wash the retractable fastback in direct sunlight or when the surface is warm.

Thoroughly rinse with lukewarm or cold water. Do not allow soap to dry on the finish.

Waxing

Wax the retractable fastback when water no longer beads on the paint. Always wash and dry it before waxing.

CAUTION

- Wiping off dust or dirt with a dry cloth will scratch the finish.
- Do not use abrasive wax. This may damage the protective coating and discolor or deteriorate the paint.

NOTE

A spot remover to remove oil, tar, and similar materials will usually also take off the wax. Rewax these areas.

Drainage outlet cleaning procedure

There are drainage outlets on the left and right of the lower side of the rear window.

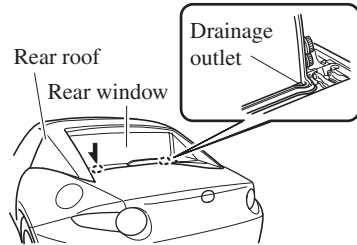

NOTE

If leaves or other foreign matter block the drainage outlets, water may enter the cabin. Clean the drainage outlets at least once a year.

1. Continue pressing the retractable fastback switch in the open direction until the rear roof is raised up from the fully closed position.
Refer to Opening the Roof on page 3-45.

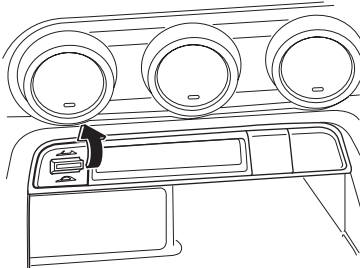

2. Remove your finger from the retractable fastback switch after the rear roof is raised up.
3. Make sure the drainage outlets are visible.

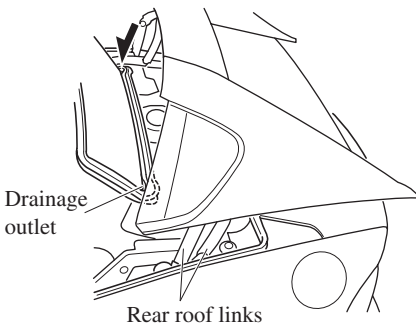

4. Switch the ignition OFF.

⚠ WARNING

Verify that the ignition is switched off:

Closing the roof with the ignition not switched off is dangerous as the motors could turn on suddenly and cause injury resulting from hands or fingers being pinched in the mechanism.

5. Remove leaves and other foreign matter accumulated in the drainage outlet.

⚠ CAUTION

When cleaning the drainage outlets, be careful not to touch the roof links or the framework of the rear roof. Otherwise, you could get injured.

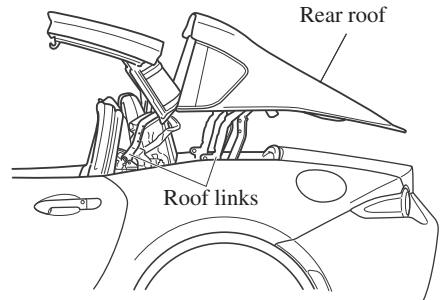

6. After cleaning is finished, continue pressing the retractable fastback switch in the close direction to close the rear roof.
Refer to Closing the Roof on page 3-45.

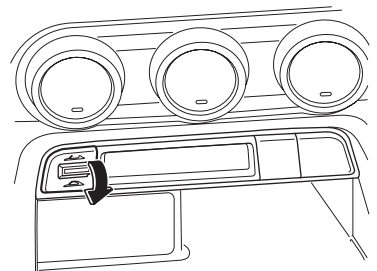

Appearance Care

▼ Plastic Part Maintenance

- When cleaning the plastic lenses of the lights, do not use gasoline, kerosene, rectified spirit, paint, thinner, highly acidic detergents, or strongly alkaline detergents. Otherwise, these chemical agents can discolor or damage the surfaces resulting in a significant loss in functionality. If plastic parts become inadvertently exposed to any of these chemical agents, flush with water immediately.
- If plastic parts such as the bumpers become inadvertently exposed to chemical agents or fluids such as gasoline, oil, engine coolant, or battery fluid, it could cause discoloration, staining, or paint peeling. Wipe off any such chemical agents or fluids using a soft cloth immediately.
- High water temperature and high water pressure car washers are available depending on the type of high pressure car washer device. If the car washer nozzle is put too close to the vehicle or aimed at one area for an extended period of time, it could deform plastic parts or damage the paint.
- Do not use wax containing compounds (polish). Otherwise, it could result in paint damage.
- In addition, do not use an electrical or air tool to apply wax. Otherwise, the frictional heat generated could result in deformation of plastic parts or paint damage.

Interior Care

WARNING

Do not spray water into the vehicle cabin:

Spraying water into the vehicle cabin is dangerous as electrical devices such as the audio and switches could get wet resulting in a malfunction or vehicle fire.

NOTE

- *Do not wipe the interior using alcohol, chlorine bleach, or organic solvents such as thinner, benzene, and gasoline. Otherwise, it may cause discoloration or stains.*
- *Rubbing hard with a stiff brush or cloth may cause damage.*

If the vehicle interior becomes soiled by any of the following, wipe it off immediately using a soft cloth. Leaving it uncleaned could cause discoloration, stains, cracks, or peeling of the coating, and it will make it hard to wipe off later.

- Beverage or fragrance
- Grease or oil
- Soiling

▼ Seat Belt Maintenance

1. Clean the soiled area by lightly dabbing it with a soft cloth soaked in a mild detergent (approx. 5%) diluted with water.
2. Wipe off the remaining detergent using a cloth soaked in clean water and wrung out well.
3. Before retracting seat belts which have been pulled out for cleaning, dry them off thoroughly and make sure there is no remaining moisture on them.

WARNING

If a seat belt appears frayed or has abrasions, have it replaced by an Authorized Mazda Dealer:

If a seat belts is used under such a condition, it cannot function at its full capacity which could result in serious injury or death.

Use a mild detergent to remove soiling from a seat belt:

If organic solvents are used for cleaning the seat belts or they become stained or bleached, there is the possibility of them becoming weakened and as a result, they may not function at their full capacity which could cause serious injury or death.

NOTE

Clean seat belts diligently if they get dirty. Leaving them uncleaned will make it difficult to clean them later, and it may affect the smooth retracting of the seat belt.

▼ Vinyl Upholstery Maintenance

Remove dust and dirt from the vinyl upholstery using a brush or vacuum. Remove soiling from vinyl upholstery using a leather and vinyl upholstery cleaner.

▼ Upholstery Maintenance

1. Clean the soiled area by lightly dabbing it with a soft cloth soaked in a mild detergent (approx. 5%) diluted with water.
2. Wipe off the remaining detergent using a cloth soaked in clean water and wrung out well.

NOTE

Rubbing the interior side of the soft top vigorously with a stiff brush or cloth may cause damage.

▼ Leather Upholstery Maintenance*

1. Remove dust and sand using a vacuum cleaner.
2. Wipe off the soiled area with a soft cloth and a suitable, special cleaner or a soft cloth soaked in a mild detergent (about 5%) diluted with water.
3. Wipe off the remaining detergent using a cloth soaked in clean water and wrung out well.
4. Remove moisture with a dry, soft cloth and allow the leather to further dry in a well-ventilated, shaded area. If the leather gets wet such as from rain, remove the moisture and dry it as soon as possible.

Appearance Care

NOTE

- *Because genuine leather is a natural material, its surface is not uniform and it may have natural scars, scratches, and wrinkles.*
- *To maintain the quality for as long as possible, periodical maintenance, about twice a year, is recommended.*
- *If the leather upholstery comes into contact with any of the following, clean it immediately.*

Leaving it uncleaned could cause premature wear, mold, or stains.

- *Sand or dirt*
- *Grease or oil, such as hand cream*
- *Alcohol, such as in cosmetic or hair dressing items*
- *If the leather upholstery gets wet, promptly remove moisture with a dry cloth. Remaining moisture on the surface may cause deterioration such as hardening and shrinkage.*
- *Exposure to direct sunlight for long periods may cause deterioration and shrinkage. When parking the car under direct sunlight for long periods, shade the interior using sunshades.*
- *Do not leave vinyl products on the leather upholstery for long periods. They may affect the leather quality and coloring. If the cabin temperature becomes hot, the vinyl may deteriorate and adhere to the genuine leather.*

▼ Plastic Part Maintenance



Do not use polishing agents. Depending on the product ingredients, they could cause discoloration, stains, cracks or peeling of the coating.

▼ Instrument Panel Top Maintenance

1. Wipe the soiled area with a soft cloth soaked in a mild detergent (approx. 5%) diluted with water.
2. Wipe off the remaining detergent using a cloth soaked in clean water and wrung out well.

▼ Panel Maintenance

If a panel becomes soiled, wipe it off with a soft cloth soaked in clean water and thoroughly wrung out.

If some areas require further cleaning, use the following procedure:

1. Wipe the soiled area with a soft cloth soaked in a mild detergent (approx. 5 %) diluted with water.
2. Wipe off the remaining detergent using a cloth soaked in clean water and wrung out well.

NOTE

Be particularly careful when cleaning shiny surface panels and metallic parts such as plating as they can be scratched easily.

▼ Cleaning the Window Interiors

If the windows become covered with an oily, greasy, or waxy film, clean them with glass cleaner. Follow the directions on the container.



- *Do not scrape or scratch the inside of the window glass. It could damage the thermal filaments.*
- *When washing the inside of the window glass, use a soft cloth dampened in lukewarm water, gently wiping the thermal filaments.*
Use of glass cleaning products could damage the thermal filaments.

▼ Cleaning the Floor Mats

Rubber floor mats should be cleaned with mild soap and water only.



Do not use rubber cleaners, such as tire cleaner or tire shine, when cleaning rubber floor mats:

Cleaning the rubber floor mats with rubber cleaning products makes the floor mats slippery.

This may cause an accident when depressing the accelerator, brake, or clutch (Manual transmission) pedal or when getting in or out of the vehicle.

After removing the floor mats for cleaning, always reinstall them securely (page 3-52).

MEMO

Helpful information on what to do if a problem arises with the vehicle.

Parking in an Emergency	7-2	Warning/Indicator Lights and Warning Sounds	7-33
Parking in an Emergency	7-2	If a Warning Light Turns On or Flashes.....	7-33
Flat Tire	7-3	Message Indicated in Multi-information Display*	7-45
Tool Storage	7-3	Message Indicated on Display	7-46
Emergency Flat Tire Repair Kit.....	7-5	Warning Sound is Activated.....	7-48
Changing a Tire.....	7-16	When Trunk Lid Cannot be Opened	7-52
Battery Runs Out	7-23	When Trunk Lid Cannot be Opened	7-52
Jump-Starting.....	7-23	When the Roof Cannot be Closed	7-57
Emergency Starting	7-26	When the Roof Cannot be Closed	7-57
Starting a Flooded Engine.....	7-26		
Push-Starting.....	7-26		
Overheating	7-27		
Overheating.....	7-27		
When Fuel-Filler Lid Cannot be Opened	7-29		
When Fuel-Filler Lid Cannot be Opened	7-29		
Emergency Towing	7-30		
Towing Description.....	7-30		
Tiedown Hooks*	7-31		

Parking in an Emergency

Parking in an Emergency

The hazard warning lights should always be used when you stop on or near a roadway in an emergency.

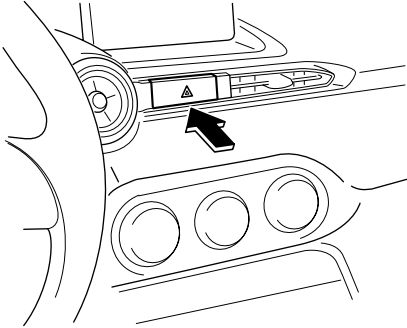

The hazard warning lights warn other drivers that your vehicle is a traffic hazard and that they must take extreme caution when near it.



Depress the hazard warning flasher and all the turn signals will flash. The hazard warning indicator lights in the instrument cluster flash simultaneously.

NOTE

- *The turn signals do not work when the hazard warning lights are on.*
- *Check local regulations about the use of hazard warning lights while the vehicle is being towed to verify that it is not in violation of the law.*

Tool Storage

NOTE

Your vehicle may or may not be equipped with a jack and lug wrench. For details, consult an Authorized Mazda Dealer.

Tools are stored in the locations illustrated in the diagram.

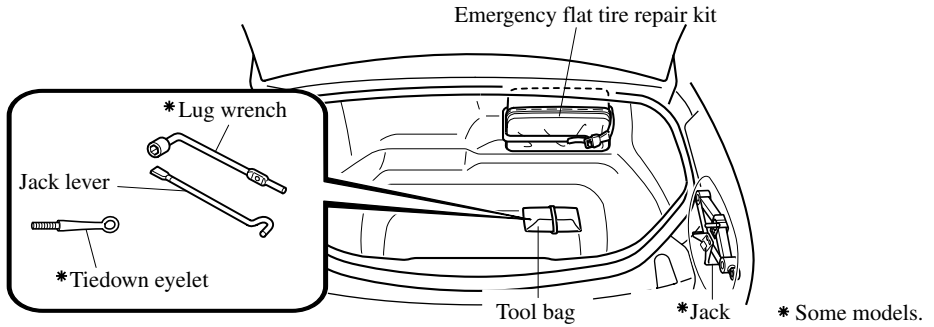

▼ **Jack***

To remove the jack

1. Remove the cover.

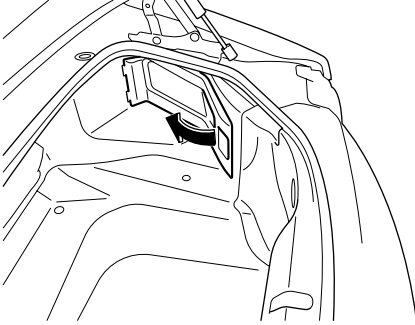

2. Turn the wing bolt and jack screw counterclockwise.

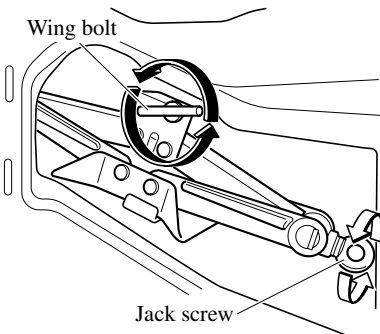

To secure the jack

1. Insert the wing bolt into the jack with the jack screw pointing back and turn the wing bolt clockwise to temporarily tighten it.
2. Turn the jack screw clockwise.

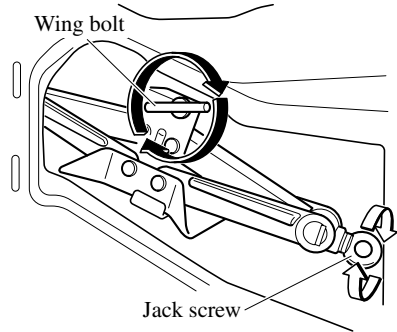

3. Turn the wing bolt completely to secure the jack.

NOTE

If the jack is not completely secured, it could rattle while driving. Make sure the jack screw is sufficiently tightened.

4. Insert the cover tabs and install the cover.

NOTE

Verify that the cover is securely installed.

Maintenance

- Always keep the jack clean.
- Make sure the moving parts are kept free from dirt or rust.
- Make sure the screw thread is adequately lubricated.

Emergency Flat Tire Repair Kit

The emergency flat tire repair kit included with your Mazda is for a temporary repair of a slightly damaged flat tire resulting from running over nails or similar sharp objects on the road surface.

Perform the emergency flat tire repair without removing the nail or similar sharp object which punctured the tire.

NOTE

Your vehicle is not equipped with a spare tire. In the event of a flat tire, use the emergency flat tire repair kit to repair the tire temporarily. When doing the repair, refer to the instructions included in the emergency flat tire repair kit. If an emergency repair was performed on a flat tire using the emergency flat tire repair kit, have an Authorized Mazda Dealer, repair or replace the tire as soon as possible.

▼ About the Emergency Flat Tire Repair Kit

The emergency flat tire repair kit includes the following items.

U.S.A. and Canada



Sealant bottle



Compressor



Speed restriction sticker



Repaired tire sticker

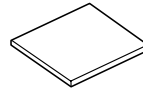

Instructions

Mexico



Tire sealant



Compressor

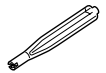

Valve core tool



Injection hose



Spare valve core



Speed restriction sticker

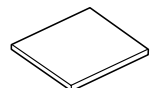

Instructions

Flat Tire

! WARNING

Do not allow children to touch the tire sealant:

- *Ingestion of tire sealant is dangerous. In the event tire sealant is accidentally swallowed, drink large amounts of water immediately and seek medical assistance.*
- *Tire sealant that comes into contact with the eyes and skin is dangerous. If tire sealant enters the eyes or contacts the skin, flush immediately with large amounts of water and seek medical assistance.*

NOTE

- *The tire sealant cannot be reused. Purchase new tire sealant at an Authorized Mazda Dealer.*
- *The emergency flat tire repair kit cannot be used in the following cases. Consult an Authorized Mazda Dealer.*
 - *The period of effective use for the tire sealant has expired. (The period of effectiveness is indicated on the bottle label.)*
 - *The tear or puncture exceeds about 4 mm (0.16 in).*
 - *The damage has occurred to an area of the tire other than the tread.*
 - *The vehicle has been driven with nearly no air remaining in the tire.*
 - *The tire has come off the wheel rim.*
 - *Damage to the wheel rim has occurred.*
 - *The tire has two or more punctures.*

▼ Using the Emergency Flat Tire Repair Kit

U.S.A. and Canada

1. Move the vehicle off the right-of-way to a safe place on a level and hard surface where the vehicle does not obstruct traffic.
2. Shift the shift lever to the 1 or Reverse (R) position for a manual transmission, and shift the selector lever to the P position for an automatic transmission.
3. Apply the parking brake with the brake pedal depressed and turn off the engine.
4. If necessary, flash the hazard warning lights and set up the roadside emergency triangle.
5. Unload passengers and cargo and remove the emergency flat tire repair kit.

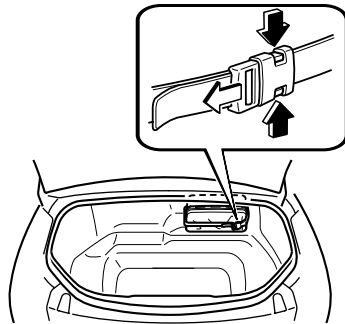

- Shake the sealant bottle to mix the contents. Then extend the injection hose.

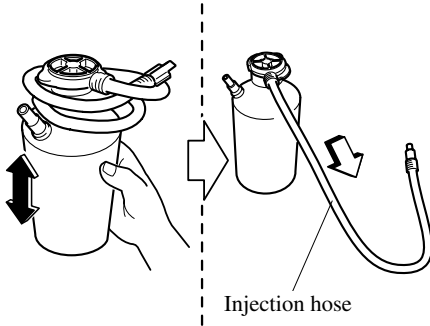

⚠ CAUTION

Do not shake the bottle excessively. Otherwise, the sealant could spray out of the injection hose, and if the sealant contacts clothing or other objects, you may not be able to remove it.

NOTE

The sealant hardens easily and injecting it will be difficult under cold weather conditions (0 °C (32 °F) or below). Warm the sealant inside the vehicle to facilitate injection.

- Pull out the air compressor hose and the air compressor plug from the air compressor.

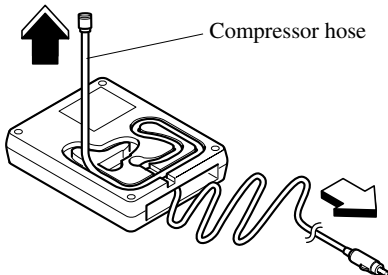

- Install the air compressor hose which was pulled out of the air compressor to the injection valve of the bottle.

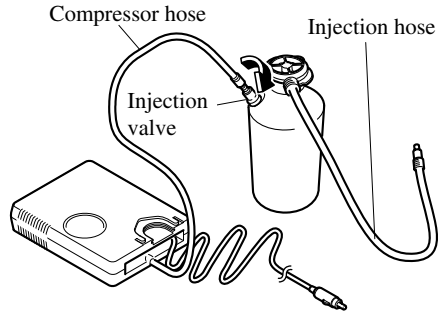

⚠ CAUTION

Make sure that the air compressor switch is off before inserting the air compressor hose to the injection valve of the bottle. If the air compressor hose is not installed to the injection valve of the bottle securely, the sealant may leak.

- Remove the valve cap from the valve of the flat tire, install the injection hose to the tire valve, turn the sleeve to the right, and tighten it.

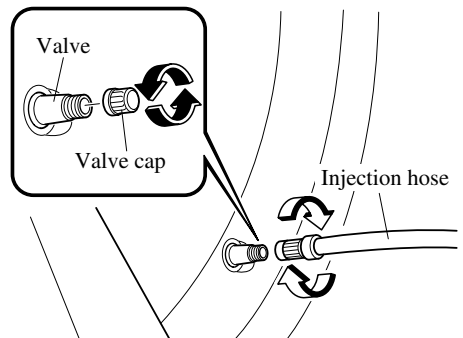

Flat Tire

10. Install the bottle to the air compressor and press it in until the left and right tabs are engaged securely.

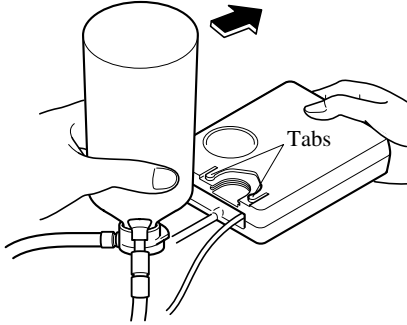

11. Insert the air compressor plug into the accessory socket inside the vehicle and switch the ignition to ACC. Refer to Accessory Sockets on page 5-134.

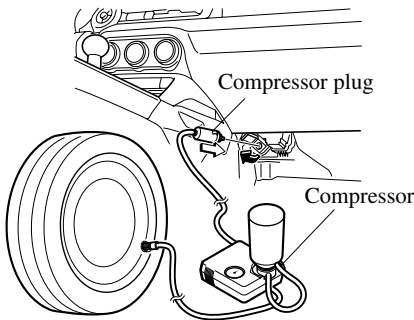

12. The sealant is injected into the tire when the air compressor is switched on. After the sealant is injected completely, wait until the tire inflation pressure increases to the specified tire inflation pressure.

NOTE

The inflation pressure may increase to about 300 kPa (3.1 kgf/cm², 3 bar, 43.5 psi) temporarily to inject the sealant through the valve. Normally, the inflation pressure decreases gradually and it reaches the actual inflation pressure after about 30 seconds.

⚠ WARNING

Never use the air compressor above 300 kPa (3.1 kgf/cm², 3 bar, 43.5 psi):

Using the air compressor at an inflation pressure above 300 kPa (3.1 kgf/cm², 3 bar, 43.5 psi) continuously is dangerous. If the air compressor overheats, hot air will be exhausted and you could get burned.

⚠ CAUTION

When inserting the air compressor plug into or removing it from the accessory socket, make sure that the air compressor switch is off. When turning the air compressor on/off, use the air compressor switch.

NOTE

- Check the tire inflation pressure label driver's door frame for the correct tire inflation pressure.
- Do not operate the air compressor for a continuous 10 minutes or longer because using it for long periods could cause a malfunction.
- If the tire inflation pressure does not increase, repair of the tire is not possible. If the tire does not reach the specified tire inflation pressure within 10 minutes, it may have received extensive damage. In this case, the repair using the emergency flat tire repair kit was not successful. Contact an Authorized Mazda Dealer.

13. Adhere the speed restriction sticker to an area where it can be viewed easily by the driver.

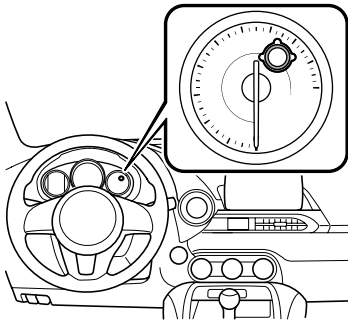

14. Adhere the repaired tire sticker to the wheel of the flat tire.

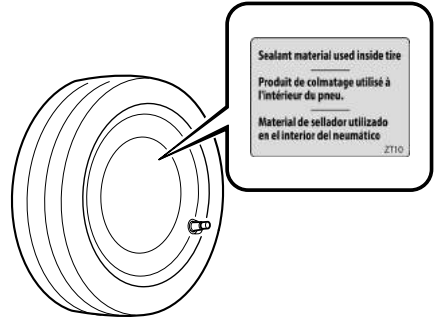

! WARNING

Do not adhere the speed restriction sticker to the padded area on the steering wheel:

Adhering the speed restriction sticker to the padded area on the steering wheel is dangerous because the air bag may not operate (deploy) normally resulting in serious injury. In addition, do not adhere the sticker to areas where warning lights or the speedometer cannot be viewed.

15. When the tire inflates to the specified tire inflation pressure, turn the air compressor switch off, turn the sleeve of the injection hose to the left, and pull it out of the tire valve.

Flat Tire

16. Remove the air compressor hose from the injection valve of the bottle. After that, install the injection hose to the injection valve of the bottle to prevent leakage of any remaining sealant.

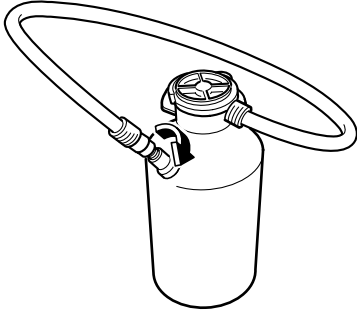

CAUTION

The remaining sealant in the hose may spray out when the hose is removed. Remove the hose carefully because you may not be able to remove the sealant contacting clothing or other objects.

17. Install the tire valve cap.
18. Put the emergency flat tire repair kit into the trunk.
19. Start driving immediately to spread the sealant in the tire.

CAUTION

Carefully drive the vehicle at a speed of 80 km/h (50 mph) or less. If the vehicle is driven at a speed of 80 km/h (50 mph) or more, the vehicle may vibrate.

NOTE

(With Tire Pressure Monitoring System)
If the tire is not properly inflated, the tire pressure monitoring system warning light will illuminate (page 4-18).

20. After driving the vehicle for about 10 minutes or 5 km (3 miles), connect the air compressor to the tire using Step 9 of the procedure, and check the tire inflation pressure using the tire pressure gauge on the air compressor. If the tire inflation pressure is lower than the specified tire inflation pressure, turn the air compressor on and wait until it reaches the specified tire inflation pressure.

WARNING

If the tire inflation pressure has decreased below 130 kPa (1.3 kgf/cm² or bar, 18.9 psi), stop driving and contact an Authorized Mazda Dealer:

The repair using the emergency flat tire repair kit was not successful.

If you see a decrease in the tire inflation pressure, even if Steps 9 to 20 of the procedure are performed repeatedly, stop driving:

Contact an Authorized Mazda Dealer.

CAUTION

Before checking the tire inflation pressure using the tire pressure gauge, turn the air compressor switch off.

21. The emergency flat tire repair is completed successfully if the tire inflation pressure does not decrease. Carefully drive the vehicle to the nearest Authorized Mazda Dealer immediately and have the flat tire replaced. Replacement with a new tire is recommended. If the tire is to be repaired or reused, consult an Authorized Mazda Dealer.

NOTE

- If an emergency flat tire repair has been performed using the emergency flat tire repair kit, Mazda recommends that the tire be replaced with a new one as soon as possible. If the tire is to be repaired or reused, consult an Authorized Mazda Dealer.
- The wheel can be reused if the sealant adhering to it is removed. However, replace the valve with a new one.

Mexico

1. Move the vehicle off the right-of-way to a safe place on a level and hard surface where the vehicle does not obstruct traffic.
2. Shift the shift lever to the 1 or Reverse (R) position for a manual transmission, and shift the selector lever to the P position for an automatic transmission.
3. Apply the parking brake with the brake pedal depressed and turn off the engine.
4. If necessary, flash the hazard warning lights and set up the roadside emergency triangle.
5. Unload passengers and cargo and remove the emergency flat tire repair kit.

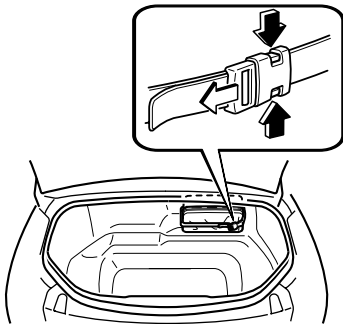

6. Shake the tire sealant well.

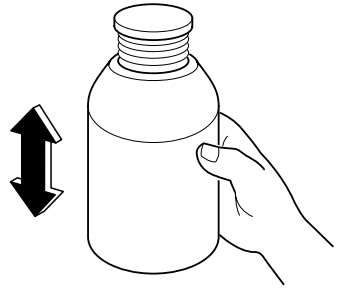

! CAUTION

If the bottle is shaken after the injection hose is screwed on, tire sealant could spray out from the injection hose. Tire sealant contacting clothing or other objects may be impossible to remove. Shake the bottle before screwing on the injection hose.

NOTE

The sealant hardens easily and injecting it will be difficult under cold weather conditions (0 °C (32 °F) or below). Warm the sealant inside the vehicle to facilitate injection.

7. Remove the cap from the bottle. Screw on the injection hose with the bottle's inner cap left on to break the inner cap.

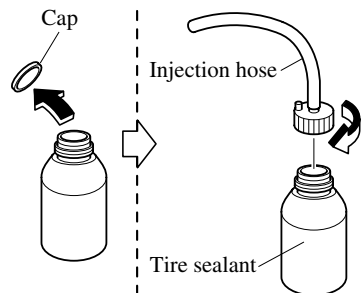

If Trouble Arises
Flat Tire

8. Remove the valve cap from the flat tire. Press the back of a valve core tool to the core of the tire valve and bleed all the remaining air.

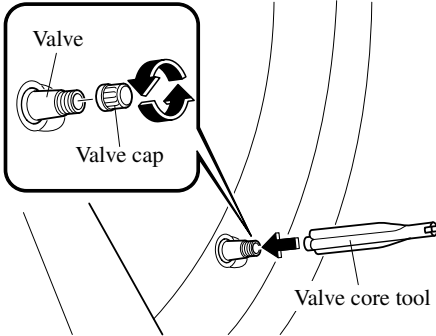

CAUTION

If there is air remaining in the tire when the valve core is removed, the valve core could fly out. Remove the valve core carefully.

9. Turn the valve core counterclockwise with the valve core tool and remove the valve core.

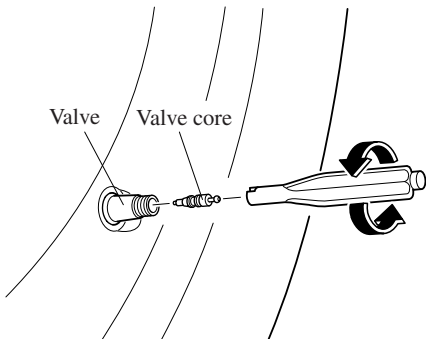

NOTE

Store the valve core in a place where it will not get dirty.

10. Insert the injection hose into the valve.

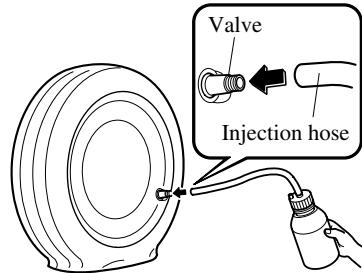

11. Hold the bottom of the bottle upright, squeeze the bottle with your hands, and inject the entire amount of tire sealant into the tire.

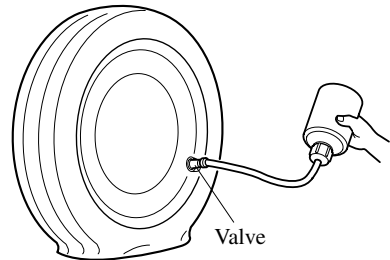

12. Pull out the injection hose from the valve.

NOTE

The tire sealant cannot be reused. Purchase a new tire sealant kit at an Authorized Mazda Dealer.

13. Reinsert the valve core into the valve and turn it clockwise to install it.

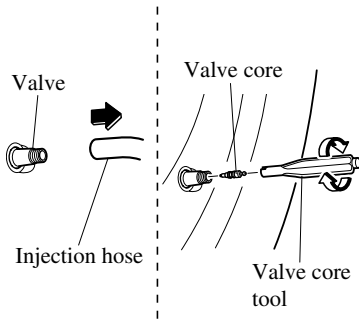

NOTE

Do not throw away the empty tire sealant bottle after use. Return the empty tire sealant bottle to an Authorized Mazda Dealer when replacing the tire. The empty tire sealant bottle will need to be used to extract and dispose of the used sealant from the tire.

14. After that, install the injection hose to the tab of the bottle to prevent leakage of any remaining sealant.

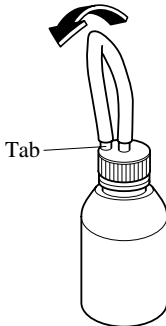

15. Adhere the speed restriction sticker to an area where it can be viewed easily by the driver.

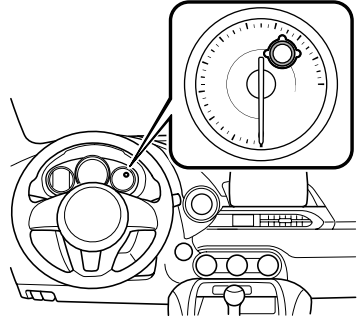

! WARNING

Do not adhere the speed restriction sticker to the padded area on the steering wheel:

Adhering the speed restriction sticker to the padded area on the steering wheel is dangerous because the air bag may not operate (deploy) normally resulting in serious injury. In addition, do not adhere the sticker to areas where warning lights or the speedometer cannot be viewed.

16. Pull out the air compressor hose and the air compressor plug from the air compressor.

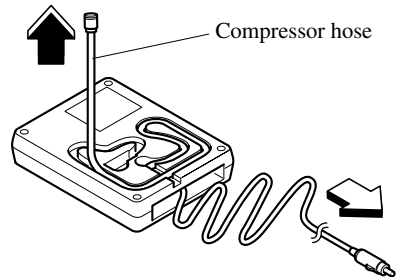

Flat Tire

17. Install the air compressor hose to the tire valve.

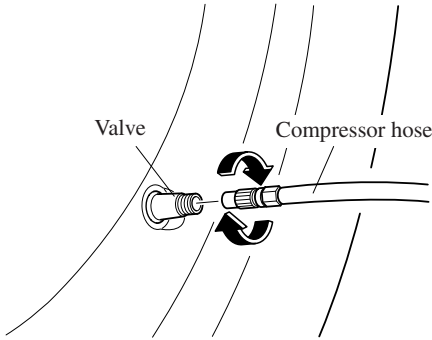

18. Insert the air compressor plug into the accessory socket inside the vehicle and switch the ignition to ACC. Refer to Accessory Sockets on page 5-134.

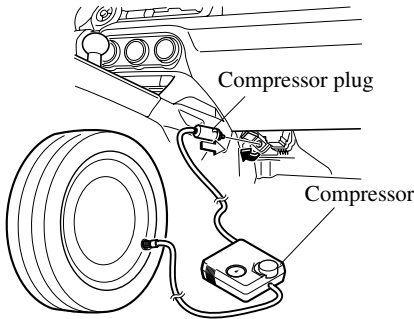

CAUTION

When inserting the air compressor plug into or removing it from the accessory socket, make sure that the air compressor switch is off. When turning the air compressor on/off, use the air compressor switch.

19. Turn the air compressor switch on and inflate the tire carefully to the correct inflation pressure.

NOTE

- Check the tire inflation pressure label driver's door frame for the correct tire inflation pressure.
- Do not operate the air compressor for a continuous 10 minutes or longer because using it for long periods could cause a malfunction.
- If the tire inflation pressure does not increase, repair of the tire is not possible. If the tire does not reach the specified tire inflation pressure within 10 minutes, it may have received extensive damage. In this case, the repair using the emergency flat tire repair kit was not successful. Contact an Authorized Mazda Dealer.
- If the tire has been over-inflated, loosen the screw cap on the air compressor and bleed some of the air out.

20. When the tire inflates to the specified tire inflation pressure, turn the air compressor switch off, turn the sleeve of the air compressor hose to the left, and pull it out of the tire valve.

21. Install the tire valve cap.

22. Put the emergency flat tire repair kit into the trunk.

23. Start driving immediately to spread the sealant in the tire.

CAUTION

Carefully drive the vehicle at a speed of 80 km/h (50 mph) or less. If the vehicle is driven at a speed of 80 km/h (50 mph) or more, the vehicle may vibrate.

24. After driving the vehicle for about 10 minutes or 5 km (3 miles), connect the air compressor to the tire using Step 17 of the procedure, and check the tire inflation pressure using the tire pressure gauge on the air compressor. If the tire inflation pressure is lower than the specified tire inflation pressure, turn the air compressor on and wait until it reaches the specified tire inflation pressure.

⚠ WARNING

If the tire inflation pressure has decreased below 130 kPa (1.3 kgf/cm² or bar, 18.9 psi), stop driving and contact an Authorized Mazda Dealer:

The repair using the emergency flat tire repair kit was not successful.

If you see a decrease in the tire inflation pressure, even if Steps 17 to 24 of the procedure are performed repeatedly, stop driving:

Contact an Authorized Mazda Dealer.

⚠ CAUTION

Before checking the tire inflation pressure using the tire pressure gauge, turn the air compressor switch off.

25. The emergency flat tire repair is completed successfully if the tire inflation pressure does not decrease. Carefully drive the vehicle to the nearest Authorized Mazda Dealer immediately and have the flat tire replaced. Replacement with a new tire is recommended. If the tire is to be repaired or reused, consult an Authorized Mazda Dealer.

NOTE

- *If an emergency flat tire repair has been performed using the emergency flat tire repair kit, Mazda recommends that the tire be replaced with a new one as soon as possible. If the tire is to be repaired or reused, consult an Authorized Mazda Dealer.*
- *The wheel can be reused if the sealant adhering to it is removed. However, replace the valve with a new one.*

▼ Inspecting the Emergency Flat Tire Repair Kit

Inspect the emergency flat tire repair kit at regular intervals.

- Check the tire sealant period of effective use.
- Check the operation of the tire compressor.

NOTE

The tire sealant has a period of effective use. Check the period of effective use indicated on the bottle label and do not use it if it has expired. Have the tire sealant replaced at an Authorized Mazda Dealer before the period of effective use has expired.

Flat Tire

Changing a Tire

! WARNING

Be sure to follow the directions for changing a tire:

Changing a tire is dangerous if not done properly. The vehicle can slip off the jack and seriously injure someone. No person should place any portion of their body under a vehicle that is supported by a jack.

Never allow anyone inside a vehicle supported by a jack:

Allowing someone to remain in a vehicle supported by a jack is dangerous. The occupant could cause the vehicle to fall resulting in serious injury.

NOTE

Make sure the jack is well lubricated before using it.

1. Park on a hard, level surface off the right-of-way and firmly set the parking brake.
2. Put a vehicle with an automatic transmission in Park (P), a manual transmission in Reverse (R) or 1, and turn off the engine.
3. Turn on the hazard warning flasher.
4. Have everyone get out of the vehicle and away from the vehicle and traffic.
5. Remove the jack and tool (page 7-3).

6. Block the wheel diagonally opposite the tire to be changed. When blocking a wheel, place a tire block both in front and behind the tire.

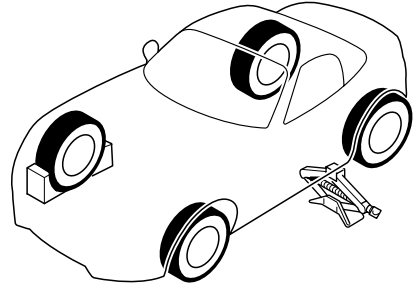

NOTE

When blocking a tire, use rocks or wood blocks of sufficient size if possible to hold the tire in place.

▼ Removing a Tire

1. Loosen the lug nuts by turning them counterclockwise one turn each, but do not remove any lug nuts until the tire has been raised off the ground.

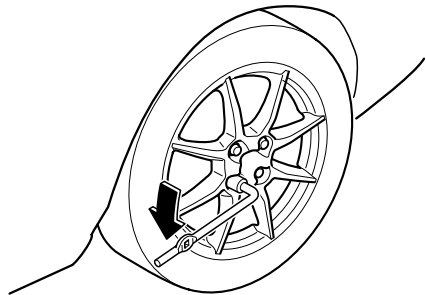

2. Place the jack on the ground.

3. Turn the jack screw in the direction shown in the figure and adjust the jack head so that it is close to the jack-up position.

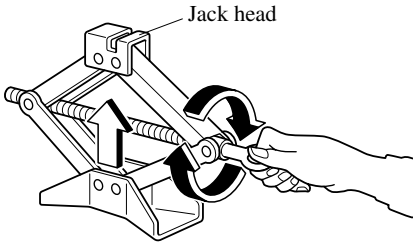

4. Place the jack under the jack-up position closest to the tire being changed with the jack head squarely under the jack-up point.

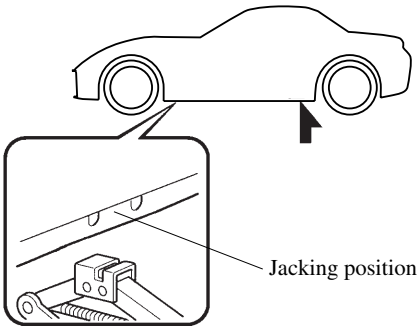

5. Continue raising the jack head gradually by rotating the screw with your hand until the jack head is inserted into the jack-up position.

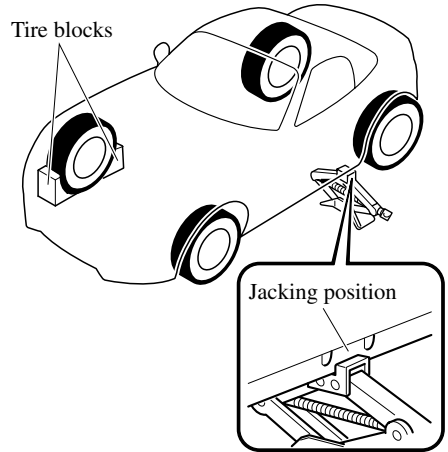

Flat Tire

⚠ WARNING

Use only the front and rear jacking positions recommended in this manual:

Attempting to jack the vehicle in positions other than those recommended in this manual is dangerous. The vehicle could slip off the jack and seriously injure or even kill someone. Use only the front and rear jacking positions recommended in this manual.

Do not jack up the vehicle in a position other than the designated jack-up position or place any objects on or under the jack:

Jacking up the vehicle in a position other than the designated jack-up position or placing objects on or under the jack is dangerous as it could deform the vehicle body or the vehicle could fall off the jack resulting in an accident.

Use only the jack provided with your Mazda:

Using a jack that is not designed for your Mazda is dangerous. The vehicle could slip off the jack and seriously injure someone.

Never place objects under the jack:

Jacking the vehicle with an object under the jack is dangerous. The jack could slip and someone could be seriously injured by the jack or the falling vehicle.

6. Insert the jack lever and attach the lug wrench to tire jack.

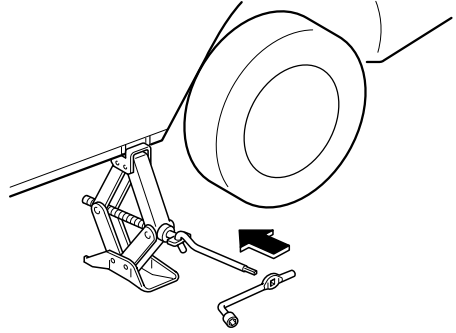

7. Turn the jack handle clockwise and raise the vehicle high enough so that the tire is raised off the ground and can be removed. Before removing the lug nuts, make sure your Mazda is firmly in position and that it cannot slip or move.

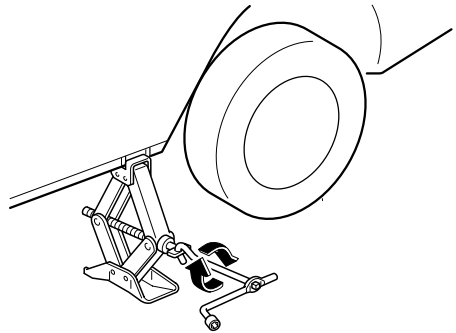

⚠ WARNING

Do not jack up the vehicle higher than is necessary:

Jacking up the vehicle higher than is necessary is dangerous as it could destabilize the vehicle resulting in an accident.

Do not start the engine or shake the vehicle while it is jacked up:

Starting the engine or shaking the vehicle while it is jacked up is dangerous as it could cause the vehicle to fall off the jack resulting in an accident.

Never go under the vehicle while it is jacked up:

Going under the vehicle while it is jacked up is dangerous as it could result in death or serious injury if the vehicle were to fall off the jack.

- Remove the lug nuts by turning them counterclockwise; then remove the wheel.

▼ Locking Lug Nuts*

If your vehicle has Mazda optional anti-theft wheel lug nuts, one on each wheel will lock the tires and you must use a special key to unlock them. This key will attach to the lug wrench. Register them with the lock manufacturer by filling out the card provided in the glove compartment and mailing it in the accompanying envelope. If you lose this key, consult an Authorized Mazda Dealer or use the lock manufacturer's order form, which is with the registration card. Accessory wheel locks cannot be used on steel wheels. This includes situations when the spare tire is installed. If the spare tire is installed, one of the original lug nuts (which should still be in the vehicle) must be installed in place of the wheel lock.

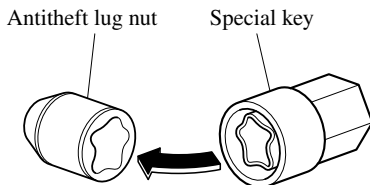
**To remove an anti-theft lug nut**

- Obtain the special key for the anti-theft lug nut.
- Place the special key on top of the anti-theft lug nut, and be sure to hold the key square to it. If you hold the key at an angle, you may damage both key and nut. Do not use a power impact wrench.
- Place the lug wrench on top of the key and apply pressure. Turn the wrench counterclockwise.

Flat Tire

To install the antitheft lug nut

1. Place the special key on top of the nut, and be sure to hold the key square to it. If you hold the key at an angle, you may damage both key and nut. Do not use a power impact wrench.
2. Place the lug wrench on top of the special key, apply pressure, and turn it clockwise.

Nut tightening torque	
N·m (kgf·m, ft·lbf)	108—147 (12—14, 80—108)

▼ Mounting the Tire

1. Remove dirt and grime from the mounting surfaces of the wheel and hub, including the hub bolts, with a cloth.

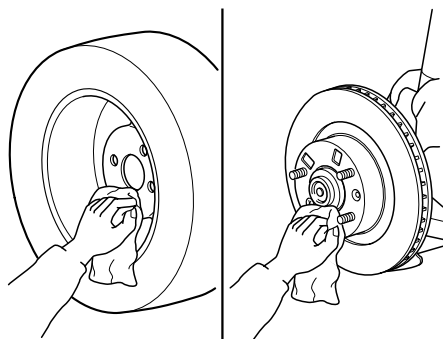

⚠ WARNING

Make sure the mounting surfaces of the wheel, hub and lug nuts are clean before changing or replacing tires:

When changing or replacing a tire, not removing dirt and grime from the mounting surfaces of the wheel, hub and hub bolts is dangerous. The lug nuts could loosen while driving and cause the tire to come off, resulting in an accident.

2. Mount the tire.
3. Install the lug nuts with the beveled edge inward; tighten them by hand.

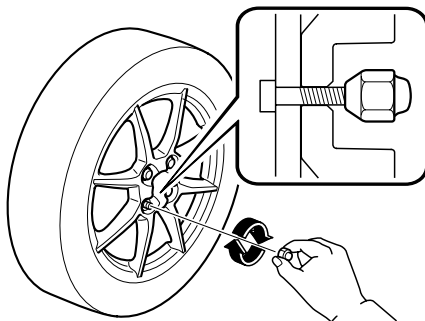

⚠ WARNING

Do not apply oil or grease to lug nuts and bolts and do not tighten the lug nuts beyond the recommended tightening torque:

Applying oil or grease to lug nuts and bolts is dangerous. The lug nuts could loosen while driving and cause the tire to come off, resulting in an accident. In addition, lug nuts and bolts could be damaged if tightened more than necessary.

- Turn the lug wrench counterclockwise and lower the vehicle. Use the lug wrench to tighten the nuts in the order shown.

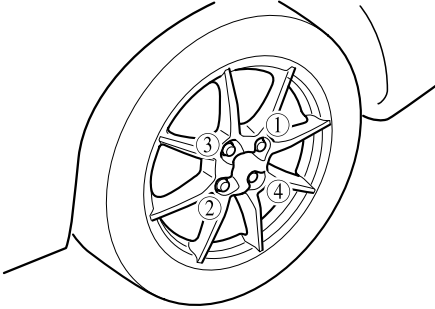

If you are unsure of how tight the nuts should be, have them inspected at an Authorized Mazda Dealer.

Nut tightening torque	
N·m (kgf·m, ft·lbf)	108—147 (12—14, 80—108)

⚠ WARNING

Always securely and correctly tighten the lug nuts:

Improperly or loosely tightened lug nuts are dangerous. The wheel could wobble or come off. This could result in loss of vehicle control and cause a serious accident.

Be sure to reinstall the same nuts you removed or replace them with metric nuts of the same configuration:

Because the wheel studs and lug nuts on your Mazda have metric threads, using a non-metric nut is dangerous. On a metric stud, it would not secure the wheel and would damage the stud, which could cause the wheel to slip off and cause an accident.

- Remove the tire blocks and store the tools and jack.
- Check the inflation pressure. Refer to Tires on page 9-8.

NOTE

(With tire pressure monitoring system)
Do not press the tire pressure monitoring system set switch after installing the spare tire. The switch is only to be pressed after installing the repaired flat tire or installing a replacement tire (page 4-18).

Flat Tire

WARNING

Do not drive with any tires that have incorrect air pressure:

Driving on tires with incorrect air pressure is dangerous. Tires with incorrect pressure could affect handling and result in an accident. When you check the regular tires' air pressure, check the spare tire, too.

NOTE

To prevent the jack and tool from rattling, store them properly.

Jump-Starting

Jump-starting is dangerous if done incorrectly. So follow the procedure carefully. If you feel unsure about jump-starting, we strongly recommend that you have a competent service technician do the work.

WARNING



Follow These Precautions Carefully:

To ensure safe and correct handling of the battery, read the following precautions carefully before using the battery or inspecting it.



Do not allow the positive (+) terminal to contact any other metal object that could cause sparks:

Flames and sparks near open battery cells are dangerous. Hydrogen gas, produced during normal battery operation, could ignite and cause the battery to explode. An exploding battery can cause serious burns and injuries. When working near a battery, do not allow metal tools to contact the positive (+) or negative (-) terminal of the battery.



Keep all flames, including cigarettes, and sparks away from open battery cells:

Flames and sparks near open battery cells are dangerous. Hydrogen gas, produced during normal battery operation, could ignite and cause the battery to explode. An exploding battery can cause serious burns and injuries.

Do not jump-start a frozen battery or one with a low fluid level:

Jump-starting a frozen battery or one with a low fluid level is dangerous. It may rupture or explode, causing serious injury.

Connect the negative cable to a good ground point away from the battery:

Connecting the end of the second jumper cable to the negative (-) terminal of the discharged battery is dangerous.

A spark could cause the gas around the battery to explode and injure someone.

Route the jumper cables away from parts that will be moving:

Connecting a jumper cable near or to moving parts (cooling fans, belts) is dangerous. The cable could get caught when the engine starts and cause serious injury.

Battery Runs Out

CAUTION

Use only a 12 V booster system. You can damage a 12 V starter, ignition system, and other electrical parts beyond repair with a 24 V power supply (two 12 V batteries in series or a 24 V motor generator set).

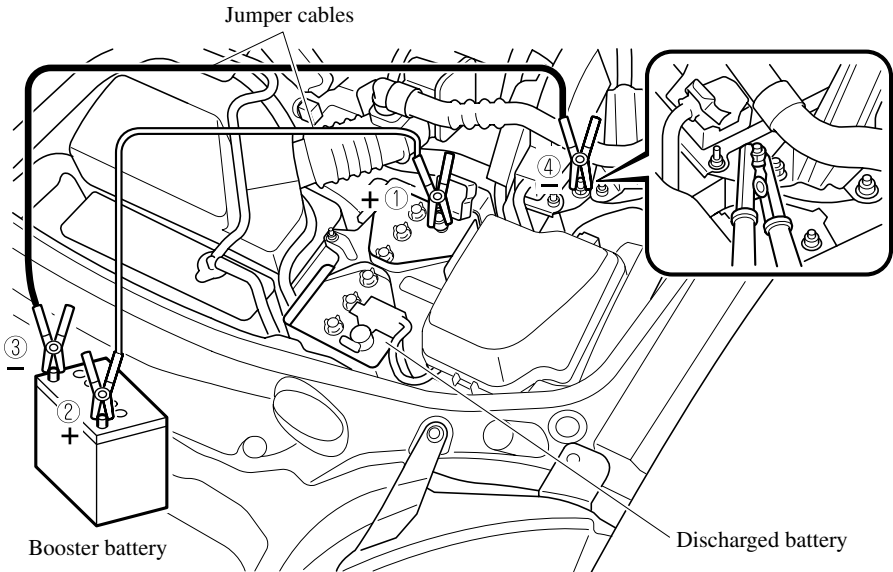

Battery Runs Out

1. Remove the battery cover.

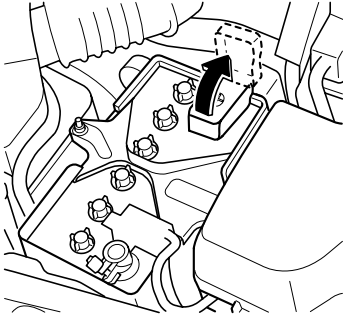

2. Make sure the booster battery is 12 V and that its negative terminal is grounded.
3. If the booster battery is in another vehicle, do not allow both vehicles to touch. Turn off the engine of the vehicle with the booster battery and all unnecessary electrical loads in both vehicles.
4. Connect the jumper cables in the exact sequence as in the illustration.
 - Connect one end of a cable to the positive terminal on the discharged battery (1).
 - Attach the other end to the positive terminal on the booster battery (2).
 - Connect one end of the other cable to the negative terminal of the booster battery (3).
 - Connect the other end to the ground point indicated in the illustration away from the discharged battery (4).
5. Start the engine of the booster vehicle and run it a few minutes. Then start the engine of the other vehicle.
6. When finished, carefully disconnect the cables in the reverse order described in the illustration.
7. If the battery cover has been removed, install it in the reverse order of removal.

NOTE

Verify that the covers are securely installed.

Emergency Starting

Starting a Flooded Engine

If the engine fails to start, it may be flooded (excessive fuel in the engine).

Follow this procedure:

1. If the engine does not start within five seconds on the first try, wait ten seconds and try again.
2. Make sure the parking brake is on.
3. Depress the accelerator all the way and hold it there.
4. Depress the clutch pedal (Manual transmission) or the brake pedal (Automatic transmission), then press the push button start. If the engine starts, release the accelerator immediately because the engine will suddenly rev up.
5. If the engine fails to start, crank it without depressing the accelerator.

If the engine still does not start using the previous procedure, have your vehicle inspected by an Authorized Mazda Dealer.

Push-Starting

Do not push-start your Mazda.

WARNING

Never tow a vehicle to start it:

Towing a vehicle to start it is dangerous. The vehicle being towed could surge forward when its engine starts, causing the two vehicles to collide. The occupants could be injured.

CAUTION

Do not push-start a vehicle that has a manual transmission. It can damage the emission control system.

NOTE

You cannot start a vehicle with an automatic transmission by pushing it.

Overheating

If the high engine coolant temperature warning light turns on, the vehicle loses power, or you hear a loud knocking or pinging noise, the engine is probably too hot.

WARNING



 Pull over to a safe location, then switch the ignition off and make sure the fan is not running before attempting to work near the cooling fan:

Working near the cooling fan when it is running is dangerous. The fan could continue running indefinitely even if the engine has stopped and the engine compartment temperature is high. You could be hit by the fan and seriously injured.



Do not remove either cooling system cap when the engine and radiator are hot:

When the engine and radiator are hot, scalding coolant and steam may shoot out under pressure and cause serious injury.

Open the hood ONLY after steam is no longer escaping from the engine:

Steam from an overheated engine is dangerous. The escaping steam could seriously burn you.

If the high engine coolant temperature warning light turns on:

1. Drive safely to the side of the road and park off the right-of-way.
2. Put a vehicle with an automatic transmission in park (P), a manual transmission in neutral.
3. Apply the parking brake.
4. Turn off the air conditioner.
5. Check whether coolant or steam is escaping from the engine compartment.

If steam is coming from the engine compartment:

Do not go near the front of the vehicle. Stop the engine. Wait until the steam dissipates, then open the hood and start the engine.

If neither coolant nor steam is escaping:

Open the hood and idle the engine until it cools.

CAUTION

If the cooling fan does not operate while the engine is running, the engine temperature will increase. Stop the engine and call an Authorized Mazda Dealer.

6. Make sure the cooling fan is operating, then turn off the engine after the temperature has decreased.
7. When cool, check the coolant level. If it is low, look for coolant leaks from the radiator and hoses.

Overheating

If you find a leak or other damage, or if coolant is still leaking:

Stop the engine and call an Authorized Mazda Dealer.

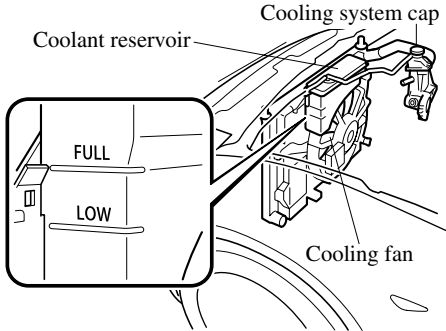

If you find no problems, the engine is cool, and no leaks are obvious:

Carefully add coolant as required (page 6-29).

⚠ CAUTION

If the engine continues to overheat or frequently overheats, have the cooling system inspected. The engine could be seriously damaged unless repairs are made. Consult an Authorized Mazda Dealer.

When Fuel-Filler Lid Cannot be Opened

When Fuel-Filler Lid Cannot be Opened

If the battery is dead, the fuel-filler lid cannot be opened.

In this case, the fuel-filler lid can be opened by taking care of the dead battery situation.

Refer to Jump-Starting on page 7-23.

If the fuel-filler lid cannot be opened even if the dead battery situation has been resolved, the electrical system may have a malfunction.

In this case, the fuel-filler lid can be opened using the following procedure as an emergency measure.

1. Open the trunk lid.
Refer to Opening and Closing the Trunk Lid on page 3-19.
2. Pull the center section of the plastic fastener and remove the fasteners.

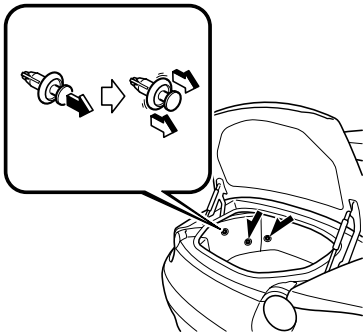

3. Partially peel back the cover inside the trunk, then pull the emergency release lever.

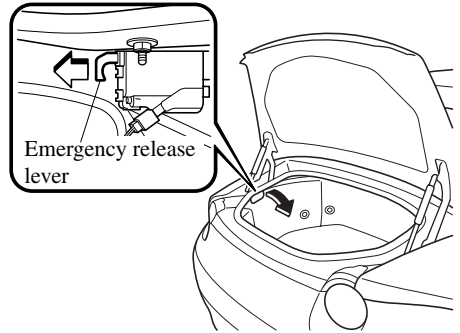

Emergency Towing

Towing Description

We recommend that towing be done only by an Authorized Mazda Dealer or a commercial tow-truck service.

Proper lifting and towing are necessary to prevent damage to the vehicle. Government and local laws must be followed.

A towed vehicle usually should have its drive wheels (rear wheels) off the ground. If excessive damage or other conditions prevent this, use wheel dollies.

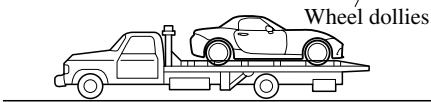
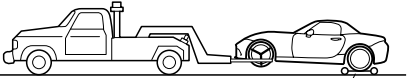
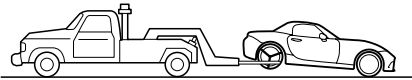

When towing with the rear wheels on the ground, release the parking brake.

CAUTION

- Do not tow the vehicle pointed backward with driving wheels on the ground. This may cause internal damage to the transmission.

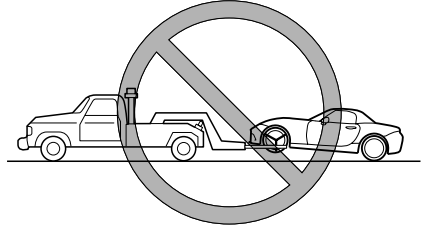

- Do not tow with sling-type equipment. This could damage your vehicle. Use wheel-lift or flatbed equipment.

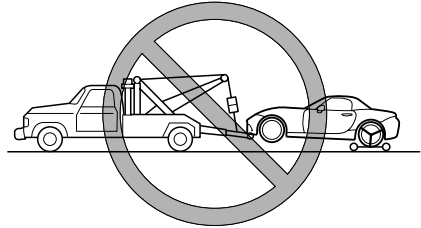

Tiedown Hooks*

⚠ CAUTION

Do not use the front and rear tiedown eyelets for towing the vehicle. They have been designed only for securing the vehicle to a transport vessel during shipping. Using the eyelets for any other purpose could result in the vehicle being damaged.

▼ Tiedown Hooks

1. Remove the tiedown eyelet and the lug wrench from the luggage compartment (page 7-3).
2. Wrap a flathead screwdriver or similar tool with a soft cloth to prevent damage to a painted bumper, and open the cap located on the front or rear bumper.

Front

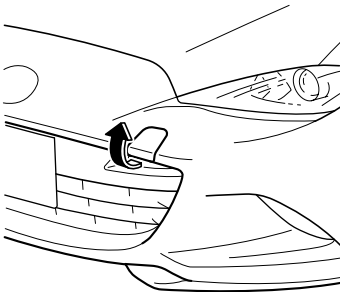

Rear

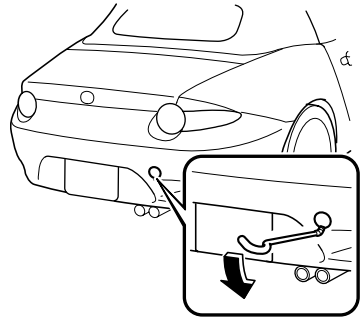

⚠ CAUTION

Do not use excessive force as it may damage the cap or scratch the painted bumper surface.

NOTE

Remove the cap completely and store it so as not to lose it.

3. Securely install the tiedown eyelet using the lug wrench or equivalent. Consult an Authorized Mazda Dealer.

Front

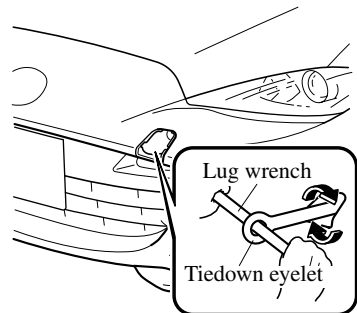

Emergency Towing

Rear

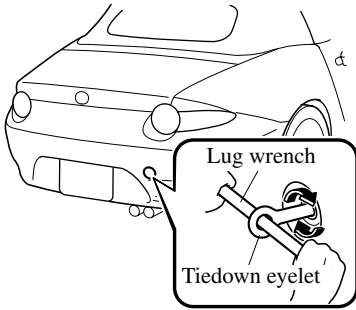

4. Hook the tying rope to the tiedown eyelet.

CAUTION

If the tiedown eyelet is not securely tightened, it may loosen or disengage from the bumper when tying the vehicle. Make sure that the tiedown eyelet is securely tightened to the bumper.

Warning/Indicator Lights and Warning Sounds

If a Warning Light Turns On or Flashes

If any warning light turns on/flashes, take appropriate action for each light. There is no problem if the light turns off, however if the light does not turn off or turns on/flashes again, consult an Authorized Mazda Dealer.



(Vehicles with type B audio)

The warning contents can be verified on the center display.



1. If the warning light is turned on, select  icon on the home screen to display the application screen.
2. Select “Vehicle Status Monitor”.
3. Select “Warning Guidance” to display the current warnings.
4. Select the applicable warning to view the warning details.

▼ Stop Vehicle in Safe Place Immediately



If any of the following warning lights turns on, the system may have a malfunction. Stop the vehicle in a safe place immediately and contact an Authorized Mazda Dealer.

Signal	Warning
 <p>Brake System Warning Light</p>	<p>This warning has the following functions:</p> <p><u>Parking brake warning/Warning light inspection</u> The light illuminates when the parking brake is applied with the ignition switched to START or ON. It turns off when the parking brake is fully released.</p> <p><u>Low brake fluid level warning</u> If the brake warning light remains illuminated even though the parking brake is released, the brake fluid may be low or there could be a problem with the brake system. Park the vehicle in a safe place immediately and contact an Authorized Mazda Dealer.</p> <p> WARNING</p> <p><i>Do not drive with the brake system warning light illuminated. Contact an Authorized Mazda Dealer to have the brakes inspected as soon as possible:</i> <i>Driving with the brake system warning light illuminated is dangerous. It indicates that your brakes may not work at all or that they could completely fail at any time. If this light remains illuminated, after checking that the parking brake is fully released, have the brakes inspected immediately.</i></p> <p> CAUTION</p> <p><i>In addition, the effectiveness of the braking may diminish so you may need to depress the brake pedal more strongly than normal to stop the vehicle.</i></p>

Warning/Indicator Lights and Warning Sounds

Signal	Warning
 <p>Electronic Brake Force Distribution System Warning</p>	<p>If the electronic brake force distribution control unit determines that some components are operating incorrectly, the control unit may illuminate the brake system warning light and the ABS warning light simultaneously. The problem is likely to be the electronic brake force distribution system.</p> <p>WARNING</p> <p>Do not drive with both the ABS warning light and brake warning light illuminated. Have the vehicle towed to an Authorized Mazda Dealer to have the brakes inspected as soon as possible:</p> <p><i>Driving when the brake system warning light and ABS warning light are illuminated simultaneously is dangerous. When both lights are illuminated, the rear wheels could lock more quickly in an emergency stop than under normal circumstances.</i></p>
 <p>Charging System Warning Indication/Warning Light</p>	<p>If the warning light illuminates while driving, it indicates a malfunction of the alternator or of the charging system. Drive to the side of the road and park off the right-of-way. Consult an Authorized Mazda Dealer.</p> <p>CAUTION</p> <p><i>Do not continue driving when the charging system warning light is illuminated because the engine could stop unexpectedly.</i></p>
 <p>Engine Oil Warning Light</p>	<p>This warning light indicates low engine oil pressure.</p> <p>CAUTION</p> <p><i>Do not run the engine if the oil pressure is low. Otherwise, it could result in extensive engine damage.</i></p> <p>If the light illuminates or the warning indication is displayed while driving:</p> <ol style="list-style-type: none"> 1. Drive to the side of the road and park off the right-of-way on level ground. 2. Turn off the engine and wait 5 minutes for the oil to drain back into the oil pan. 3. Inspect the engine oil level 6-28. If it's low, add the appropriate amount of engine oil while being careful not to overfill. <p>CAUTION</p> <p><i>Do not run the engine if the oil level is low. Otherwise, it could result in extensive engine damage.</i></p> <ol style="list-style-type: none"> 4. Start the engine and check the warning light. <p>If the light remains illuminated even though the oil level is normal or after adding oil, stop the engine immediately and have your vehicle towed to an Authorized Mazda Dealer.</p>





Warning/Indicator Lights and Warning Sounds

Signal	Warning
 <p>(Red) High Engine Coolant Temperature Warning Indication/Warning Light</p>	<p>The light flashes when the engine coolant temperature is extremely high, and illuminates when the engine coolant temperature increases further.</p> <p>Handling Procedure</p> <p>Flashing light Drive slowly to reduce engine load until you can find a safe place to stop the vehicle and wait for the engine to cool down.</p> <p>Illuminated light This indicates the possibility of overheating. Park the vehicle in a safe place immediately and stop the engine. Refer to Overheating 7-27.</p> <div style="border: 1px solid black; padding: 5px; display: inline-block;">  CAUTION </div> <p><i>Do not drive the vehicle with the high engine coolant temperature warning light illuminated. Otherwise, it could result in damage to the engine.</i></p>
 <p>Power Steering Malfunction Indicator Light</p>	<p>The light illuminates if the electric power steering has a malfunction. If the light illuminates, stop the vehicle in a safe place and do not operate the steering wheel. There is no problem if the light turns off after a while. Contact an Authorized Mazda Dealer if the light illuminates continuously.</p> <p>NOTE</p> <ul style="list-style-type: none"> • <i>If the indicator light illuminates, the power steering will not operate normally. If this happens, the steering wheel can still be operated, however, the operation may feel heavy compared to normal, or the steering wheel could vibrate when turning.</i> • <i>Repeatedly jerking the steering wheel left and right while the vehicle is stopped or moving extremely slowly will cause the power steering system to go into protective mode which will make the steering feel heavy, but this does not indicate a problem. If this occurs, park the vehicle safely and wait several minutes for the system to return to normal.</i>







Warning/Indicator Lights and Warning Sounds

▼ Contact Authorized Mazda Dealer and Have Vehicle Inspected





If any of the following warning lights or the indicator light turns on/flashes, the system may have a malfunction. Contact an Authorized Mazda Dealer to have your vehicle inspected.

Signal	Warning
 <p>Master Warning Indication/Warning Light*</p>	<p>Type A instrument cluster (Master warning indication) Displays when notification of the system malfunctions is required. Check the message indicated in the display and consult an Authorized Mazda Dealer. (Master warning light) The master warning light displays when a warning message occurs. This indicates a malfunction with the vehicle system. Check the message indicated in the display and consult an Authorized Mazda Dealer. For details, refer to the explanations for the warning/indicator lights, in the warning/indicator lights section, which match the symbol in the upper part of the display. If a message is not indicated in the display, operate the INFO switch to display the “Warning” screen. Refer to Message Indicated in Multi-information Display and INFO switch on page 4-18.</p> <p>Type B instrument cluster The light illuminates continuously if any one of the following occurs. Consult an Authorized Mazda Dealer.</p> <ul style="list-style-type: none"> •There is a malfunction in the battery management system. •There is a malfunction in the brake switch.
 <p>Electric Vacuum Pump Warning Light</p>	<p>The light turns on if the electric vacuum pump system has a problem. Have your vehicle inspected at an Authorized Mazda Dealer.</p>
 <p>ABS Warning Light</p>	<p>If the ABS warning light stays on while you're driving, the ABS control unit has detected a system malfunction. If this occurs, your brakes will function normally as if the vehicle had no ABS. Should this happen, consult an Authorized Mazda Dealer as soon as possible.</p> <p>NOTE</p> <ul style="list-style-type: none"> •When the engine is jump-started to charge the battery, uneven rpm occurs and the ABS warning light may illuminate. If this occurs, it is the result of the weak battery and does not indicate an ABS malfunction. Recharge the battery. •The brake assist system does not operate while the ABS warning light is illuminated.
 <p>Check Engine Light</p>	<p>If this light illuminates while driving, the vehicle may have a problem. It is important to note the driving conditions when the light illuminated and consult an Authorized Mazda Dealer. The check engine light may illuminate in the following cases:</p> <ul style="list-style-type: none"> •The engine's electrical system has a problem. •The emission control system has a problem. •The fuel tank level being very low or approaching empty. •The fuel-filler cap is missing or not tightened securely. <p>If the check engine light remains on, or it flashes continuously, do not drive at high speeds and consult an Authorized Mazda Dealer as soon as possible.</p>





Warning/Indicator Lights and Warning Sounds

Signal	Warning
<p>AT Automatic Transmission Indication/Warning Light*</p>	<p>The indication/light illuminates when the transmission has a problem.</p> <div data-bbox="300 272 535 320" style="border: 1px solid black; padding: 5px; text-align: center;">  CAUTION </div> <p><i>If the automatic transmission warning indication/light illuminates, the transmission has an electrical problem. Continuing to drive your Mazda in this condition could cause damage to your transmission. Consult an Authorized Mazda Dealer as soon as possible.</i></p>
<p> (Illuminate) TCS/DSC Indicator Light</p>	<p>If the light stays on, the TCS, DSC or the brake assist system may have a malfunction and they may not operate correctly. Take your vehicle to an Authorized Mazda Dealer.</p>
<p> Air Bag/Seat Belt Pretensioner System Warning Light</p>	<p>A system malfunction is indicated if the warning light constantly flashes, constantly illuminates or does not illuminate at all when the ignition is switched ON. If any of these occur, consult an Authorized Mazda Dealer as soon as possible. The system may not operate in an accident.</p> <div data-bbox="292 671 527 719" style="border: 1px solid black; padding: 5px; text-align: center;">  WARNING </div> <p>Never tamper with the air bag/pretensioner systems and always have an Authorized Mazda Dealer perform all servicing and repairs: <i>Self-servicing or tampering with the systems is dangerous. An air bag/pretensioner could accidentally activate or become disabled causing serious injury or death.</i></p>
<p> (Flashing) Tire Pressure Monitoring System Warning Light*</p>	<p>If the tire pressure monitoring system has a malfunction, the tire pressure warning light flashes. Have your vehicle checked by an Authorized Mazda Dealer as soon as possible.</p> <div data-bbox="292 887 527 935" style="border: 1px solid black; padding: 5px; text-align: center;">  WARNING </div> <p>If the tire pressure monitoring system warning light illuminates or flashes, or the tire pressure warning beep sound is heard, decrease vehicle speed immediately and avoid sudden maneuvering and braking: <i>If the tire pressure monitoring system warning light illuminates or flashes, or the tire pressure warning beep sound is heard, it is dangerous to drive the vehicle at high speeds, or perform sudden maneuvering or braking. Vehicle drivability could worsen and result in an accident.</i> <i>To determine if you have a slow leak or a flat, pull over to a safe position where you can check the visual condition of the tire and determine if you have enough air to proceed to a place where air may be added and the system monitored again by an Authorized Mazda Dealer or a tire repair station.</i></p> <p>Do not ignore the TPMS Warning Light: <i>Ignoring the TPMS warning light is dangerous, even if you know why it is illuminated. Have the problem taken care of as soon as possible before it develops into a more serious situation that could lead to tire failure and a dangerous accident.</i></p>



Warning/Indicator Lights and Warning Sounds

Signal	Warning
 <p>(Red) KEY Warning Indication*</p>	<p>“Keyless System malfunction” is displayed This message is displayed if the advanced keyless entry & push button start system has a problem. Contact an Authorized Mazda Dealer.</p> <div data-bbox="252 338 490 386" style="border: 1px solid black; padding: 5px; margin: 10px 0;">  CAUTION </div> <p><i>If the message is indicated, or the push button start indicator light (amber) flashes, the engine may not start. If the engine cannot be started, try starting it using the emergency operation for starting the engine, and have the vehicle inspected at an Authorized Mazda Dealer as soon as possible. Refer to Emergency Operation for Starting the Engine on page 4-9.</i></p>
 <p>(Amber) KEY Warning Indication*</p>	<p>“Ignition is on” is displayed This message is displayed when the driver's door is opened without switching the ignition off.</p> <p>“Key not detected” is displayed This message is displayed when any of the following operations is performed with the key out of the operational range or placed in areas inside the cabin where it is difficult for the key to be detected.</p> <ul style="list-style-type: none"> •The push button start is pressed with the ignition switched off •The ignition is switched on •All doors are closed without switching the ignition off
 <p>(Red) (Illuminate) KEY Warning Light*</p>	<p>If any malfunction occurs in the keyless entry system, it illuminates continuously.</p> <div data-bbox="252 813 490 861" style="border: 1px solid black; padding: 5px; margin: 10px 0;">  CAUTION </div> <p><i>If the key warning indicator light illuminates or the push button start indicator light (amber) flashes, the engine may not start. If the engine cannot be started, try starting it using the emergency operation for starting the engine, and have the vehicle inspected at an Authorized Mazda Dealer as soon as possible.</i></p> <p>Refer to Emergency Operation for Starting the Engine on page 4-9.</p>

Warning/Indicator Lights and Warning Sounds

Signal	Warning
 <p>(Illuminate) Lane Departure Warning System (LDWS) Warning Indication/Warning Light*</p>	<ul style="list-style-type: none"> •The warning indication/warning light illuminates if there is a problem with the system. Have your vehicle inspected at an Authorized Mazda Dealer. •The LDWS does not operate when the warning indication/warning light illuminates. <div style="border: 1px solid black; padding: 5px; margin: 10px 0;"> <p>⚠ CAUTION</p> </div> <ul style="list-style-type: none"> ➤A problem in the system may be indicated under the following conditions. Have your vehicle inspected at an Authorized Mazda Dealer. <ul style="list-style-type: none"> ➤When the warning indication/warning light illuminates while driving the vehicle. When the system is canceled automatically, the warning indication/warning light illuminates. Normally, the system restores automatically and the warning indication/warning light turns off, however, if the warning indication/warning light illuminates, there may be a problem with the system. ➤The warning indication/warning light does not illuminate when the ignition is switched ON. ➤Always use tires for all wheels that are of the specified size, and the same manufacture, brand, and tread pattern. In addition, do not use tires with significantly different wear patterns on the same vehicle. If such improper tires are used, the LDWS may not operate normally. ➤When an emergency spare tire is used, the system may not operate normally. <p>NOTE <i>If the windshield area in front of the Forward Sensing Camera (FSC) is fogged or obstructed, the light turns on temporarily. If the light remains turned on, there may be a problem with the system.</i></p>
 <p>(Amber) High Beam Control System (HBC) Warning Indication/ Warning Light*</p>	<p>The warning indication/warning light illuminates if there is a problem with the system. Have your vehicle inspected at an Authorized Mazda Dealer.</p> <p>NOTE <i>If the windshield area in front of the Forward Sensing Camera (FSC) is fogged or obstructed, the warning indication/warning light illuminates temporarily. If the warning indication/warning light illuminates, there may be a problem with the system.</i></p>
 <p>Blind Spot Monitoring (BSM) Warning Indication*</p>	<p>The message is displayed when the system has a malfunction. Have your vehicle inspected by an Authorized Mazda Dealer.</p> <p>NOTE <i>If the vehicle is driven on a road with less traffic and few vehicles that the radar sensors can detect, the system may pause. However, it does not indicate a malfunction.</i></p>
 <p>Blind Spot Monitoring (BSM) OFF Indicator Light*</p>	<p>A problem in the system may be indicated under the following conditions. Have your vehicle inspected at an Authorized Mazda Dealer.</p> <ul style="list-style-type: none"> •The light does not turn on when the ignition is switched ON. •The light remains on even when the Blind Spot Monitoring (BSM) system can be operated. •The light turns on while driving the vehicle. <p>NOTE <i>If the vehicle is driven on a road with less traffic and few vehicles that the radar sensors can detect, the system may pause (The Blind Spot Monitoring (BSM) OFF indicator light in the instrument cluster illuminates). However, it does not indicate a malfunction.</i></p>

Warning/Indicator Lights and Warning Sounds

Signal	Warning
 <p>Retractable Fastback Warning Indication*</p>	The message is displayed when the system has a malfunction. Have your vehicle inspected by an Authorized Mazda Dealer.
 <p>LED Headlight Warning Light</p>	This light illuminates if there is a malfunction in the LED headlight. Have your vehicle inspected by an Authorized Mazda Dealer.





Warning/Indicator Lights and Warning Sounds

▼ Taking Action

Take the appropriate action and verify that the warning light turns off.

Signal	Warning	Action to be taken
 <p>Seat Belt Warning Light</p>	<p><u>Except Mexico</u></p> <p>The seat belt warning light turns on if the driver or passenger's seat is occupied and the seat belt is not fastened with the ignition switched ON. If the driver or passenger's seat belt is unfastened (only when the passenger's seat is occupied) and the vehicle is driven at a speed faster than about 20 km/h (12 mph), the warning light flashes. After a short time, the warning light stops flashing, but remains illuminated.</p> <p><i>NOTE</i></p> <ul style="list-style-type: none"> • <i>The warning light flashes for about 6 seconds if the driver's seat belt is not fastened when the ignition is switched ON.</i> • <i>To allow the passenger occupant classification sensor to function properly, do not place and sit on an additional seat cushion on the passenger's seat. The sensor may not function properly because the additional seat cushion could cause sensor interference.</i> • <i>If a small child is seated on the passenger's seat, the warning light may not operate.</i> <p><u>Mexico</u></p> <p>The seat belt warning light turns on if the driver or passenger's seat is occupied and the seat belt is not fastened with the ignition switched ON. If the driver or passenger's seat belt is unfastened (only when the passenger's seat is occupied) and the vehicle is driven at a speed faster than about 20 km/h (12 mph), the warning light flashes. After a short time, the warning light stops flashing, but remains illuminated. If a seat belt remains unfastened, the warning light flashes again for a given period of time.</p> <p><i>NOTE</i></p> <ul style="list-style-type: none"> • <i>Placing heavy items on the passenger's seat may cause the passenger's seat belt warning function to operate depending on the weight of the item.</i> • <i>To allow the passenger seat weight sensor to function properly, do not place and sit on an additional seat cushion on the passenger's seat. The sensor may not function properly because the additional seat cushion could cause sensor interference.</i> • <i>If a small child is seated on the passenger's seat, the warning light may not operate.</i> 	<p>Fasten the seat belts.</p>

Warning/Indicator Lights and Warning Sounds

Signal	Warning	Action to be taken
 <p>Door-Ajar/Trunk lid-Ajar Warning Indication/Warning Light</p>	<p>The light turns on if any door/trunk lid is not closed securely.</p>	<p>Close the door/trunk lid securely.</p>
 <p>Low Fuel Warning Light</p>	<p>The light turns on when the remaining fuel is about 9.0 L (2.3 US gal, 1.9 Imp gal).</p> <p>NOTE <i>The light illumination timing may vary because fuel inside the fuel tank moves around according to the driving conditions and the vehicle posture.</i></p>	<p>Add fuel.</p>
 <p>Check Fuel Cap Warning Light</p>	<p>If the check fuel cap warning light illuminates while driving, the fuel-filler cap may not be installed properly.</p>	<p>Stop the engine and reinstall the fuel-filler cap. Refer to Fuel-Filler Cap on page 3-26</p>
 <p>Low Washer Fluid Level Warning Indication/Warning Light*</p>	<p>This warning light indicates that little washer fluid remains.</p>	<p>Add washer fluid (page 6-31).</p>



Warning/Indicator Lights and Warning Sounds

Signal	Warning	Action to be taken
 <p>(Illuminate) Tire Pressure Monitoring System Warning Light*</p>	<p>When the warning light illuminates, and the warning beep sound is heard (about 3 seconds), tire pressure is too low in one or more tires.</p> <p>! WARNING</p> <p>If the tire pressure monitoring system warning light illuminates or flashes, or the tire pressure warning beep sound is heard, decrease vehicle speed immediately and avoid sudden maneuvering and braking:</p> <p>If the tire pressure monitoring system warning light illuminates or flashes, or the tire pressure warning beep sound is heard, it is dangerous to drive the vehicle at high speeds, or perform sudden maneuvering or braking. Vehicle drivability could worsen and result in an accident. To determine if you have a slow leak or a flat, pull over to a safe position where you can check the visual condition of the tire and determine if you have enough air to proceed to a place where air may be added and the system monitored again by an Authorized Mazda Dealer or a tire repair station.</p> <p>Do not ignore the TPMS Warning Light: Ignoring the TPMS warning light is dangerous, even if you know why it is illuminated. Have the problem taken care of as soon as possible before it develops into a more serious situation that could lead to tire failure and a dangerous accident.</p>	<p>Inspect the tires and adjust to the specified inflation pressure (page 6-41).</p> <p>NOTE</p> <ul style="list-style-type: none"> • Perform tire pressure adjustment when the tires are cold. Tire pressure will vary according to the tire temperature, therefore let the vehicle stand for 1 hour or only drive it 1.6 km (1 mile) or less before adjusting the tire pressures. When pressure is adjusted on hot tires to the cold inflation pressure, the TPMS warning light/beep may turn on after the tires cool and pressure drops below specification. • Also, an illuminated TPMS warning light, resulting from the tire air pressure dropping due to cold ambient temperature will remain illuminated even if the ambient temperature rises. In this case, it will also be necessary to adjust the tire air pressures. If the TPMS warning light illuminates due to a drop in tire air pressure, make sure to check and adjust the tire air pressures. • Tires lose air naturally over time and the TPMS cannot tell if the tires are getting too soft over time or you have a flat. However, when you find one low tire in a set of four—that is an indication of trouble; you should have someone drive the vehicle slowly forward so you can inspect any low tire for cuts and any metal objects sticking through tread or sidewall. Put a few drops of water in the valve stem to see if it bubbles indicating a bad valve. Leaks need to be addressed by more than simply reinflating the tire as leaks are dangerous — take it to an Authorized Mazda Dealer.

Warning/Indicator Lights and Warning Sounds

KEY Indication (White)/KEY Warning Light (Red)*

Take the appropriate action and verify that the warning light turns off.

Signal	Cause	Action to be taken
 (White) KEY Indication*		
 (Red) (Flashing) KEY Warning Light*	The advanced key battery is dead.	Replace the key battery (page 6-38).
 (Red) (Flashing) KEY Warning Light*	The advanced key is not within the operation range.	Bring the advanced key into the operation range (page 3-7).
	The advanced key is placed in areas inside the cabin where it is difficult for the key to be detected.	
	A key from another manufacturer similar to the advanced key is in the operation range.	Take the key from another manufacturer similar to the advanced key out of the operation range.
	Without the ignition switched off, the advanced key is taken out of the cabin, and then all the doors are closed.	Bring the advanced key back into the cabin.

Warning/Indicator Lights and Warning Sounds

Message Indicated in Multi-information Display*

If there is a notification from the vehicle, a message is displayed in the multi-information display. Check the information and take the necessary action.

(Display example)

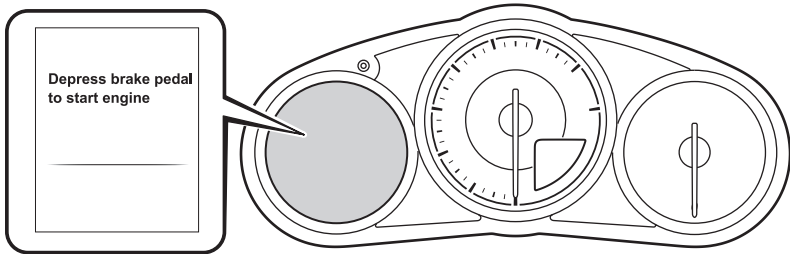

If the warning light turns on/flashes simultaneously or a symbol is indicated in the display, check the information regarding the warning light or symbol. (page 4-26)

Display	Content	Action to be taken
Move Shift Lever to "P" Position	Indicated when the push button start is pressed while the shift lever is not in the P position.	Shift the shift lever to the P position.
Depress brake pedal to start engine	Indicated when the push button start is pressed without depressing the brake pedal.	Depress the brake pedal and press the push button start.
Depress clutch pedal to start engine	Indicated when the push button start is pressed without depressing the clutch pedal.	Depress the clutch pedal and press the push button start.

Warning/Indicator Lights and Warning Sounds

Message Indicated on Display

If a message is displayed in the center display (Type B audio), take appropriate action (in a calm manner) according to the displayed message.

(Display example)

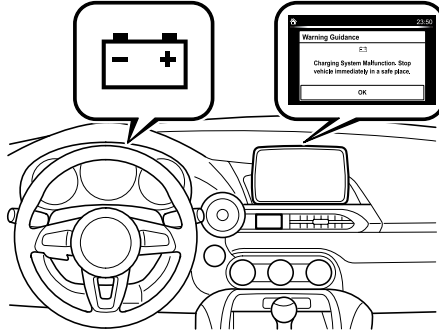

▼ Stop Vehicle in Safe Place Immediately

If the following messages are displayed in the center display (Type B audio), a vehicle system may be malfunctioning. Stop the vehicle in a safe place and contact an Authorized Mazda Dealer.

Display	Indicated Condition
<p>The screenshot shows a home icon and the time 23:50 in the top left corner. Below that is a 'Warning Guidance' header with a downward arrow icon. The main text reads: 'Engine Coolant Temperature High. Stop vehicle immediately in a safe place.' At the bottom is an 'OK' button.</p>	<p>Displays if the engine coolant temperature has increased excessively.</p>
<p>The screenshot shows a home icon and the time 23:50 in the top left corner. Below that is a 'Warning Guidance' header with a battery icon. The main text reads: 'Charging System Malfunction. Stop vehicle immediately in a safe place.' At the bottom is an 'OK' button.</p>	<p>Displays if the charging system has a malfunction.</p>

Warning/Indicator Lights and Warning Sounds

▼ Verify Display Content

Displays in the following cases:

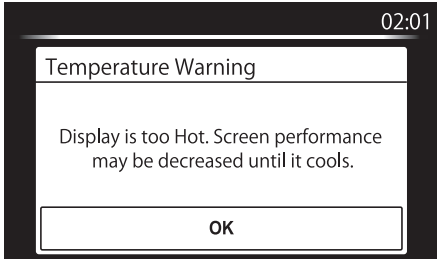
Display	Indicated Condition/Action to be taken
	<p>The following message is displayed when the temperature around the center display is high. Lowering the temperature in the cabin or the temperature around the center display by avoiding direct sunlight is recommended.</p>

Warning/Indicator Lights and Warning Sounds

Warning Sound is Activated

▼ Lights-On Reminder

The lights-on reminder is operable when the time setting*¹ of the auto headlight off function is off.

If lights are on and the ignition is switched to ACC or off, a continuous beep sound will be heard when the driver's door is opened.

*1 If the light switch is left on, the auto headlight off function automatically turns off the lights about 30 seconds after switching the ignition off. The time setting can be changed. Refer to Personalization Features on page 9-9.

NOTE

- When the ignition is switched to ACC, the “Ignition Not Switched Off (STOP) Warning Beep” (page 7-49) overrides the lights-on reminder.
- A personalized function is available to change the sound volume for the lights-on reminder.
Refer to Personalization Features on page 9-9.

▼ Air Bag/Seat Belt Pretensioner System Warning Beep

If there is a problem with the air bag/seat belt pretensioner systems and the warning light illumination, a warning beep sound will be heard for about 5 seconds every minute.

The air bag and seat belt pretensioner system warning beep sound will continue to be heard for approximately 35 minutes. Have your vehicle inspected at an Authorized Mazda Dealer as soon as possible.

WARNING

Do not drive the vehicle with the air bag/seat belt pretensioner system warning beep sounding:

Driving the vehicle with the air bag/seat belt pretensioner system warning beep sounding is dangerous. In a collision, the air bags and the seat belt pretensioner system will not deploy and this could result in death or serious injury. Contact an Authorized Mazda Dealer to have the vehicle inspected as soon as possible.

Warning/Indicator Lights and Warning Sounds

▼ Seat Belt Warning Beep

Except Mexico

If the driver's seat belt is not fastened when the ignition is switched ON, a beep sound will be heard for about 6 seconds. If the driver or the passenger's seat belt is not fastened and the vehicle is driven at a speed faster than about 20 km/h (12 mph), a beep sound will be heard again for a specified period of time. Until a seat belt is fastened or a given period of time has elapsed, the beep sound will not stop even if the vehicle speed falls below 20 km/h (12 mph).

NOTE

- *To allow the passenger occupant classification sensor to function properly, do not place and sit on an additional seat cushion on the passenger's seat. The sensor may not function properly because the additional seat cushion could cause sensor interference.*
- *If a small child is seated on the passenger's seat, the warning beep may not operate.*

Mexico

If the vehicle speed exceeds about 20 km/h (12 mph) with the driver or passenger's seat belt unfastened, a warning beep sounds continuously. If the seat belt remains unfastened, the beep sound stops once and then continues for about 90 seconds. The beep stops after the driver or passenger's seat belt is fastened. Until a seat belt is fastened or a given period of time has elapsed, the beep sound will not stop even if the vehicle speed falls below 20 km/h (12 mph).

NOTE

- *Placing heavy items on the passenger's seat may cause the passenger's seat belt warning function to operate depending on the weight of the item.*
- *To allow the passenger seat weight sensor to function properly, do not place and sit on an additional seat cushion on the passenger's seat. The sensor may not function properly because the additional seat cushion could cause sensor interference.*
- *If a small child is seated on the passenger's seat, the warning beep may not operate.*

▼ Retractable Fastback Warning Beep*

When operating the retractable fastback switch, the warning beep is activated when the retractable fastback operation begins and when it is completed. If there is a problem with the retractable fastback, the warning beep is activated continuously while operating the switch. If the warning beep is activated continuously while operating the switch, have the vehicle inspected at an Authorized Mazda Dealer .

▼ Ignition Not Switched Off (STOP) Warning Beep

If the driver's door is opened with the ignition switched to ACC, a beep will be heard continuously in the cabin to notify the driver that the ignition has not been switched OFF (STOP). Under this condition, the keyless entry system will not operate, the vehicle cannot be locked, and the battery voltage will be depleted.

Warning/Indicator Lights and Warning Sounds

▼ Key Removed from Vehicle Warning Beep

Vehicles with advanced keyless function

If the key is taken out of the vehicle while the ignition is not switched OFF and all the doors are closed, the beep which sounds outside of the vehicle will be heard 6 times, the beep which sounds inside the vehicle will be heard 6 times, and the KEY warning light (red) in the instrument cluster flashes continuously to notify the driver that the ignition has not been switched OFF.

Vehicles without advanced keyless function

If the key is taken out of the vehicle while the ignition is not switched OFF and all the doors are closed, a beep will be heard in the cabin 6 times and the KEY warning light (red) in the instrument cluster turns on continuously to notify the driver that the ignition has not been switched OFF.

NOTE

Because the key utilizes low-intensity radio waves, the Key Removed From Vehicle Warning may activate if the key is carried together with a metal object or it is placed in a poor signal reception area.

▼ Request Switch Inoperable Warning Beep (With the advanced keyless function)

If the request switch is pressed with the door open or ajar, or the ignition is not switched OFF with a key being carried, a beep will be heard outside for about 2 seconds to notify the driver that the door or trunk lid cannot be locked.

▼ Key Left-in-trunk Warning Beep (With the advanced keyless function)

If the key is left in the trunk with all the doors locked and the trunk lid closed, a beep will be heard outside for about 10 seconds to notify the driver that the key is in the trunk. In this case, take out the key by pressing the electric trunk lid opener and opening the trunk lid. The key taken out of the trunk may not operate because its functions have been temporarily stopped. To restore the key's functions, perform the applicable procedure (page 3-7).

▼ Key Left-in-vehicle Warning Beep (With the advanced keyless function)

If all the doors and trunk are locked using another key while the key is left in the cabin, the beep which sounds outside of the vehicle will be heard for about 10 seconds to notify the driver that the key is in the cabin. In this case, take out the key by opening the door. A key taken out of the vehicle using this method may not operate because its functions have been temporarily stopped. To restore the key's functions, perform the applicable procedure (page 3-7).

▼ Power Steering Warning Buzzer

If the power steering system has a malfunction, the power steering malfunction light turns on or flashes and the buzzer operates at the same time. Refer to Warning Indication/Warning Lights on page 4-26.

Warning/Indicator Lights and Warning Sounds

▼ Tire Inflation Pressure Warning Beep*

The warning beep sound will be heard for about 3 seconds when there is any abnormality in tire inflation pressures (page 4-105).

▼ Blind Spot Monitoring (BSM) System Warning Beep*

Driving forward

The warning beep operates when the turn signal lever is operated to the side where the Blind Spot Monitoring (BSM) warning light is illuminated.

NOTE

A personalized function is available to change the Blind Spot Monitoring (BSM) warning beep sound volume. Refer to Personalization Features on page 9-9.

Reversing

If a moving object such as a vehicle or two-wheeled vehicle approaches on the left or right from behind your vehicle, the Blind Spot Monitoring (BSM) warning sound is activated.

▼ Lane Departure Warning Sound*

While the system is operating, if the system determines that the vehicle may depart from the lane, it sounds a warning sound.

NOTE

- *The volume of the LDWS warning sound can be changed. Refer to Personalization Features on page 9-9.*
- *The type of the LDWS warning sound can be changed. Refer to Personalization Features on page 9-9.*

When Trunk Lid Cannot be Opened

When Trunk Lid Cannot be Opened

If the battery is dead, the trunk cannot be unlocked and opened.

In this case, the trunk can be unlocked by taking care of the dead battery situation.

Refer to Jump-Starting on page 7-23.

If the trunk cannot be unlocked even if the dead battery situation has been resolved, the electrical system may have a malfunction.

Soft top model

1. Close the convertible top.
Refer to Raising the Convertible Top on page 3-37.
2. Remove the windblocker.

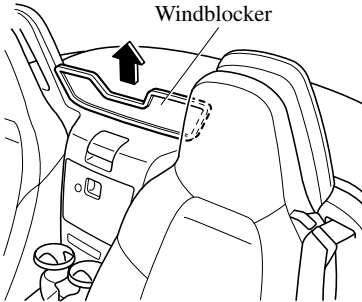

3. Remove the fasteners on the right side of the vehicle.

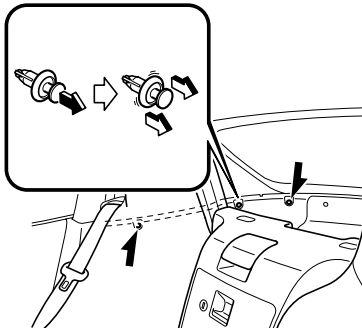

4. Partially peel back the cover on the right side of the vehicle.

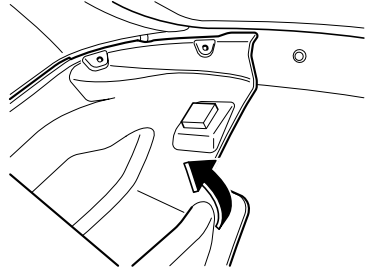

5. Turn and loosen the cap screws until the screws start to spin free.

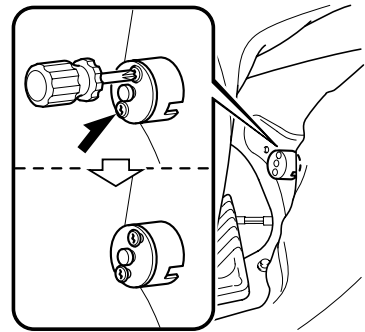

When Trunk Lid Cannot be Opened

6. Pull out the cap and open the trunk lid. After performing this emergency measure, have the vehicle inspected at an Authorized Mazda Dealer as soon as possible.

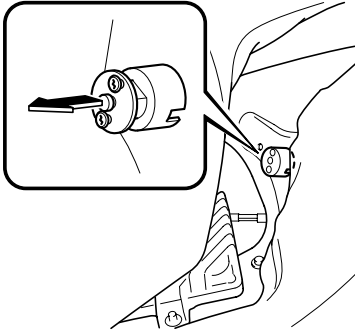

⚠ CAUTION

Do not pull the screw when pulling the cap. Otherwise, the screw may fall off and become lost.

Retractable fastback model

⚠ CAUTION

Do not touch the linkage and gears. If sharp edges and gears are touched, it could cause injury.

Roof operates electrically

1. Remove the antenna if it is installed. Refer to Antenna on page 5-13.
2. Start the engine.
3. Continue pressing the retractable fastback switch in the open direction until the rear roof is completely open. Refer to Opening the Roof on page 3-45.

Multi-information display indication

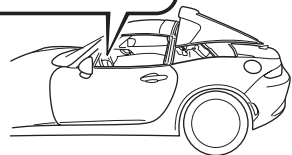
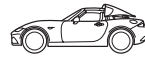

NOTE

Stop operating the switch before the front roof opens. If the switch is continuously pressed, the front roof opens and the following procedures cannot be performed.

4. Switch the ignition OFF.

When Trunk Lid Cannot be Opened

5. Remove the fasteners on the right side of the vehicle.

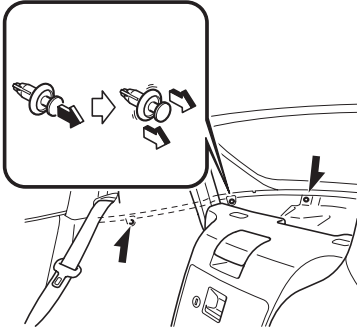

6. Push the stopper rubber through the cover on the right side of the vehicle while slightly lifting the cover up.

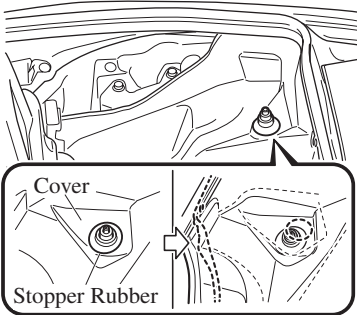

7. Lift up the cover from the outside of the vehicle.

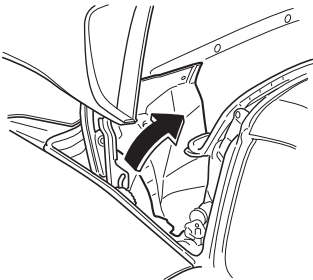

8. Insert your hand beneath the lifted cover and loosen the cap screws until they spin freely.

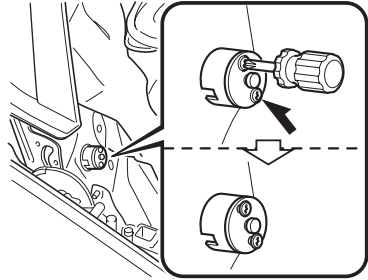

NOTE

At this point, do not pull out the cap. If the cap is pulled out, the trunk lock will release but the rear roof will not operate electrically.

9. Start the engine.
10. Continue pressing the retractable fastback switch in the close direction until the rear roof is completely closed. Refer to Closing the Roof on page 3-45.

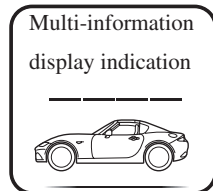

11. Switch the ignition OFF.

When Trunk Lid Cannot be Opened

12. Remove the windblocker.

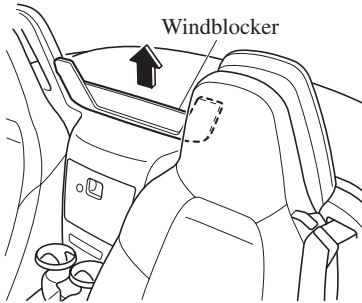

13. Partially peel back the cover on the right side from the middle of the vehicle.

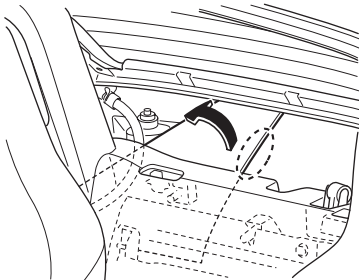

14. Pull out the cap and release the trunk lock.

After performing this emergency measure, have the vehicle inspected at an Authorized Mazda Dealer as soon as possible.

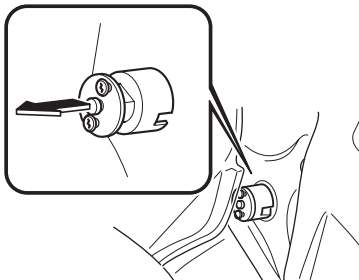

⚠ CAUTION

Do not pull the screw when pulling the cap. Otherwise, the screw may fall off and become lost.

Roof does not operate electrically

1. Remove the antenna if it is installed. Refer to Antenna on page 5-13.
2. Lift up the rear roof by hand. Refer to When the Roof Cannot be Closed on page 7-57.
3. Remove the fasteners on the right side of the vehicle.

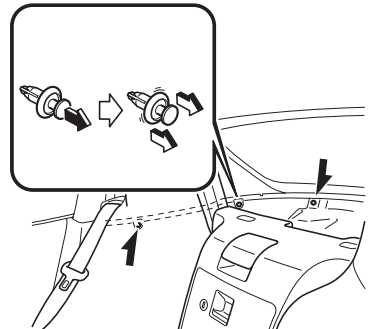

4. Push the stopper rubber through the cover on the right side of the vehicle while slightly lifting the cover up.

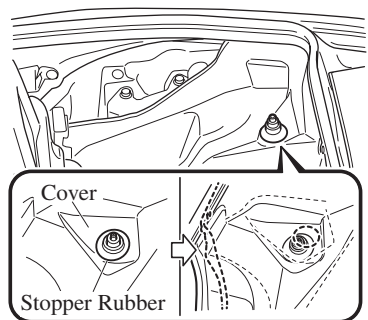

When Trunk Lid Cannot be Opened

5. Lift up the cover from the outside of the vehicle.

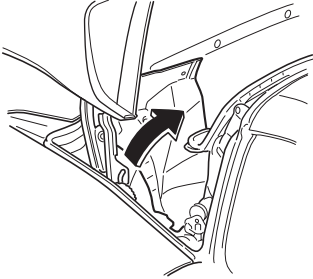

6. Insert your hand beneath the lifted cover and loosen the cap screws until they spin freely.

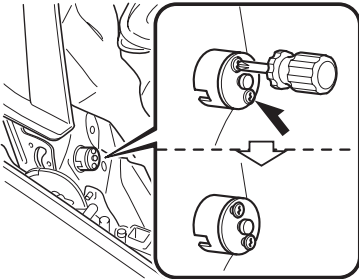

7. Pull out the cap and release the trunk lock.

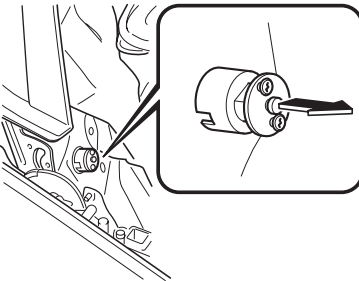

CAUTION

At this point, do not open the trunk. If the trunk is opened before the rear roof is completely closed, the trunk may contact the rear roof and cause damage and become scratched.

8. Close the rear roof by hand. Refer to When the Roof Cannot be Closed on page 7-57.
9. Open the trunk lid. After performing this emergency measure, have the vehicle inspected at an Authorized Mazda Dealer as soon as possible.

When the Roof Cannot be Closed

When the Roof Cannot be Closed

If the roof cannot be closed electrically by pressing the retractable fastback switch, verify the roof operation conditions first.

Refer to Operation Conditions on page 3-44.

If the roof cannot be closed even after the operation conditions are all met, have it checked at an Authorized Mazda Dealer.

If you are unable to have the roof checked at an Authorized Mazda Dealer, the roof can be closed manually as an emergency measure.

The procedure for manually closing the roof is as follows:

1. Opening the rear roof

Release the locks of the rear roof and open it.

2. Closing the front roof

Lift up the front roof and close it.

3. Closing the rear roof

Tie the ropes to the rear roof links and close the rear roof.

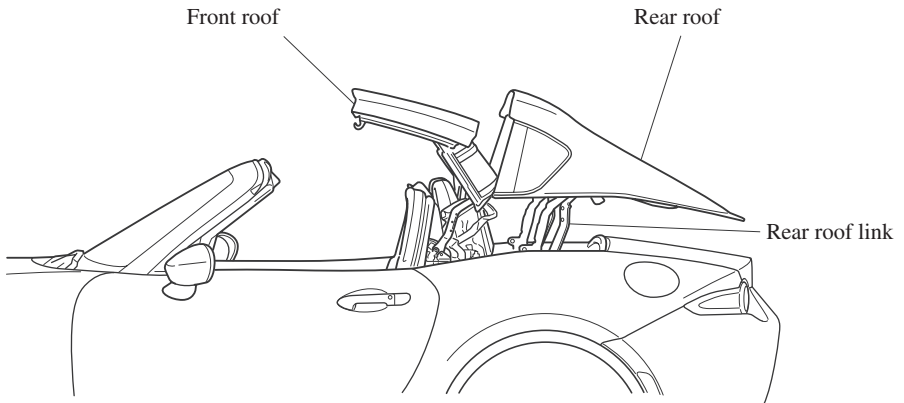

⚠ CAUTION

- Do not drive the vehicle with the roof partially open. The vehicle operation may be affected by the wind and could result in an accident.
- Do not perform the procedure in a strong wind as it could cause an unexpected accident.
- Two adults are required to perform the procedure, especially when lifting up the front roof. Do not do it alone so as not to cause injury or vehicle damage.
- Some steps in the procedure require using multiple tools at the same time and a certain level of technical expertise. In addition, holding your body extended over the car can result in muscle strains so Mazda recommends having the roof checked at an Authorized Mazda Dealer.

When the Roof Cannot be Closed

NOTE

- This procedure is for manually closing the roof as an emergency measure. After closing the roof manually, electric operation is not possible until the system is restored by an Authorized Mazda Dealer.
- Using a flashlight will facilitate the procedure.

▼ Manual closing

Before closing manually



Verify that the ignition is switched off before manually operating the roof:

Manually closing the roof with the ignition not switched off is dangerous as the motors could turn on suddenly and cause injury resulting from hands or fingers being pinched in the mechanism.

1. Park on a hard, level surface off the right-of-way and firmly set the parking brake.
2. Put a vehicle with an automatic transmission in Park (P), a manual transmission in Neutral.
3. Switch the ignition off while depressing the brake pedal.
4. Turn on the hazard warning flasher if it is needed.

Tool preparation

Take out the five tools stored in the seat side box.

Refer to Seat Side Box on page 5-138.

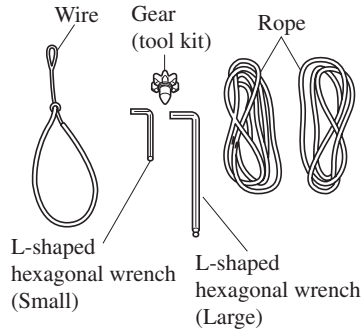

Opening the rear roof



- When turning the bolt, cover the front roof using a cloth. The front roof may be damaged if the L-shaped hexagonal wrench contacts it.
- Because the clearance with the stored front roof is narrow, be careful not to let the L-shape hexagonal wrench contact the roof when turning the bolt.

NOTE

Moving the seats as far forward as possible and folding the seatbacks forward will facilitate the procedure.

Refer to Seat Operation on page 2-4.

When the Roof Cannot be Closed

1. Remove the antenna if it is installed. Refer to When the Antenna on page 5-13.
2. Insert the short end of the L-shaped hexagonal wrench (Large) into the motor bracket bolt.

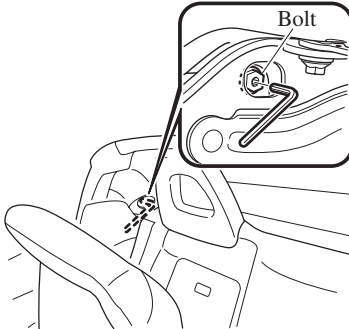

NOTE

If it is difficult to see the bolt, remove the windblocker and identify the bolt from the center of the vehicle.

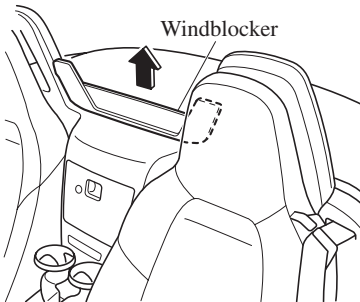

3. Turn the L-shaped hexagonal wrench (Large) counterclockwise to loosen the bolt slightly.

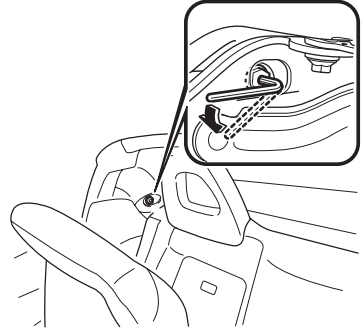

4. Remove the L-shaped hexagonal wrench (Large) once from the bolt, then insert the long end of the wrench into the bolt.

NOTE

The tip of the long end of the L-shaped hexagonal wrench can be used at an angle. Moving the wrench upward slightly will increase the clearance between the rear roof and the stored front roof and facilitate the procedure.

5. Turn the L-shaped hexagonal wrench (Large) counterclockwise 13 times or more while pressing the wrench against the bolt.

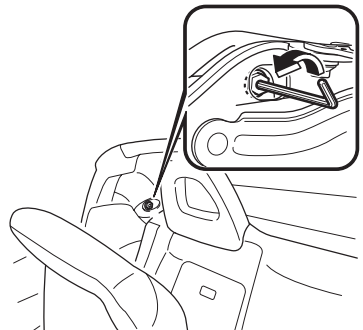

When the Roof Cannot be Closed

NOTE

- *The bolt cannot be removed completely.*
 - *If it is hard to turn the bolt, repeat Step 3 a few times.*
6. Hook the wire to the link pin shown in the figure.
 7. While one person pushes the rear roof down, another person pulls the wire until a latch sound is heard and the rear roof unlocks.

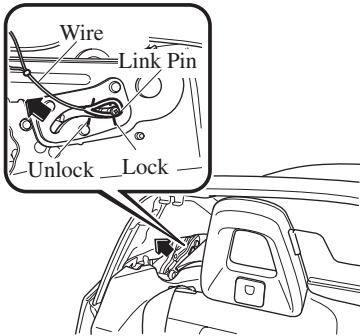

8. Do the same procedure on the other side.
9. While standing on both sides of the vehicle, lift the rear roof to the position it stops while keeping the height of its left and right sides as parallel as possible.

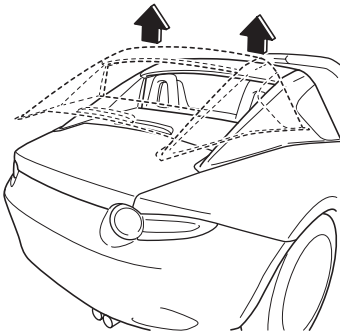

! CAUTION

- *Do not let go of the rear roof on both sides until it is fully open. The rear roof could fall if it is released too soon and cause injury.*
- *Do not attempt to forcefully lift the rear roof. If the rear roof is forcefully lifted without being unlocked, it could damage vehicle parts.*
- *Lift the rear roof with its left and right height as parallel as possible. If the rear roof is lifted with the left or right height slanted, it could deform the link mechanism.*

Closing the front roof

! CAUTION

- *Some steps in the procedure require holding your body in a strained position and if over exerted it could result in injury.*
- *Do the procedure being very careful not to get your hands and fingers caught while closing the front roof. Otherwise, your hands or fingers could be injured.*
- *Removal of the headliner is included in the procedure, however, never drive the vehicle with the headliner removed. Driving the vehicle with the headliner removed is prohibited by law. Correctly perform the procedure while following the instructions.*

When the Roof Cannot be Closed

1. While standing on both sides of the vehicle, hold the front and rear sides of the front roof and pull the front roof upward.

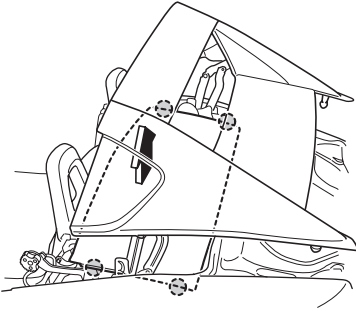

2. Switch your hand on the rear side of the front roof to the front side and pull the front roof forward.

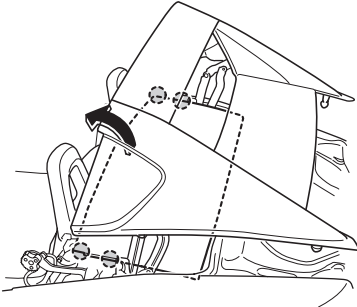

3. Stop pulling the front roof before it completely closes.

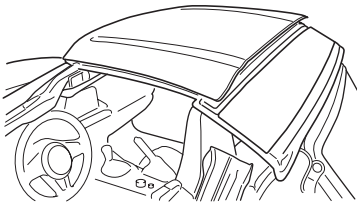

NOTE

The next step cannot be done if the front roof is closed completely.

4. Remove the link covers on the left and right sides by pulling them out by hand.

Link cover

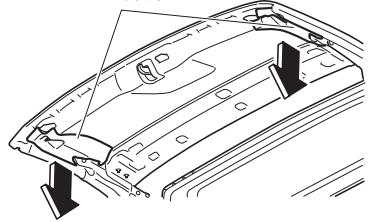

5. Remove the fasteners and the headliner.

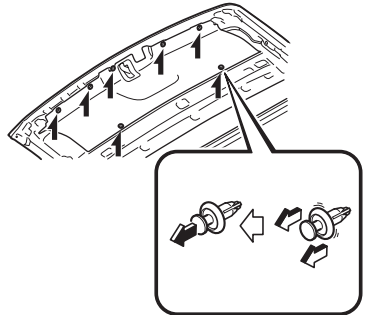

6. Lightly press the front edge of the front roof from outside of the vehicle to close the front roof completely.

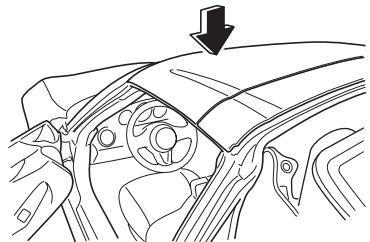

When the Roof Cannot be Closed

7. Insert the short end of the hexagonal wrench (Small) into the gear (tool kit) and assemble.

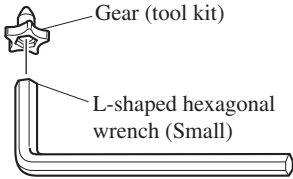

8. Insert the point of the gear (tool kit) into the hole beside the top lock motor gear with the hexagonal wrench inserted into the gear tool.

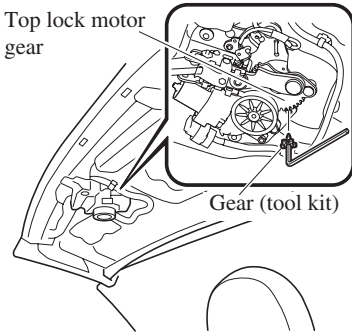

9. Rotate the hexagonal wrench and move the hook in the lock direction so that there is enough space for the opening of the headliner to be attached to the hook.

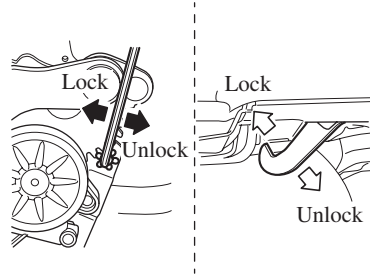

NOTE

Turning the gear (tool kit) requires some effort due to motor resistance. Slowly operate the hexagonal wrench.

10. Insert the hook into the opening of the headliner

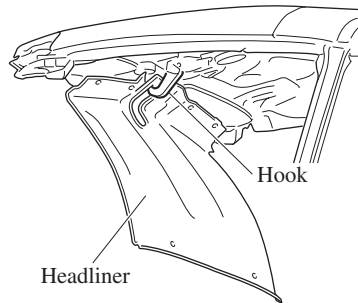

CAUTION

Insert the gear (tool kit) securely until it engages with the top lock motor gear. If the gear (tool kit) is not inserted securely, it may come off and be damaged.

When the Roof Cannot be Closed

11. Turn the hexagonal wrench (Small) and gear (tool kit) counterclockwise and engage the hook with the vehicle body side.

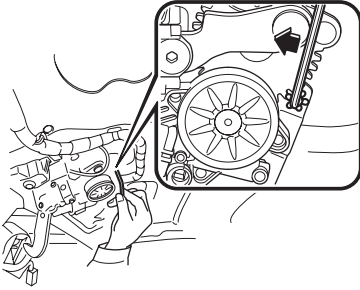

NOTE

The top lock lever completely engages with the vehicle body (locked condition) at the position where the teeth of the gear (tool kit) contact the bracket.

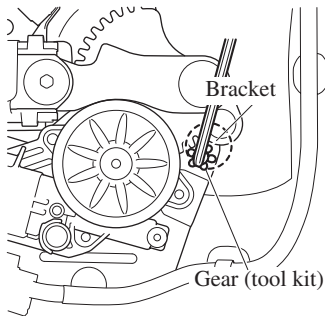

12. Lift the rear end of the headliner with it hinged on the opening of the headliner.

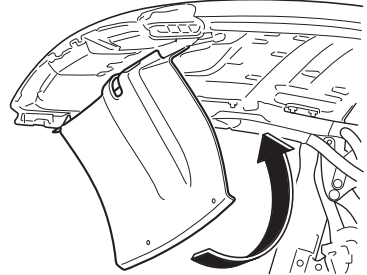

13. Install the headliner to the front roof using the fasteners at two locations.

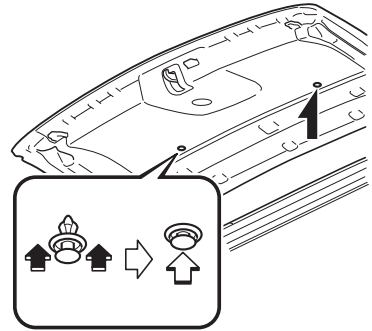

NOTE

The fasteners in the five locations at the front of the headliner are not fastened. Do not lose the fasteners because they are needed for the required servicing at the Authorized Mazda Dealer.

14. Install the left and right link covers from the vehicle interior.

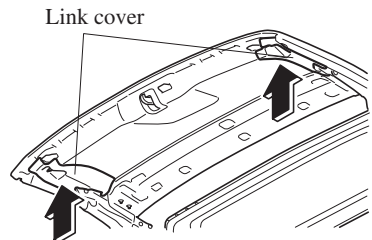

When the Roof Cannot be Closed

Closing the rear roof

CAUTION

- Slowly close the rear roof. If the rear roof is closed suddenly, a hand or other body part may be pinched, leading to a serious injury.
 - Do not attempt to forcefully push the rear roof. Pushing the rear roof forcefully may damage vehicle parts.
1. Fold the rope in half and hook it to the link pin of the rear roof.

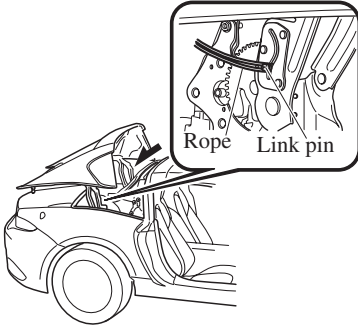

2. Do the same procedure on the other side.
3. Close the rear roof uniformly on both sides using two adults, one on each side of the vehicle.

CAUTION

Close the rear roof with its left and right positions as parallel as possible. If the rear roof is closed with its left or right height slanted, it could deform the link mechanism.

4. Slowly close the rear roof while lightly pulling the rope with one hand so that the rope does not unhook.

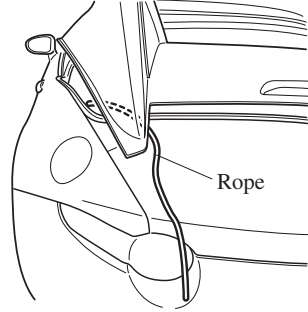

NOTE

Route the rope rearward through the clearance between the rear roof and trunk.

5. One person pushes the rear roof down and the other person pulls the rope strongly and straight back towards the vehicle rear until a click sound is heard.

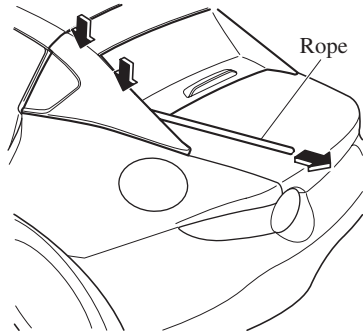

When the Roof Cannot be Closed

NOTE

- The rear roof is locked completely if the position where the rope is hooked is at the rear end of the bracket groove in the direction of the vehicle rear, as shown in the figure, when viewed from the vehicle interior.

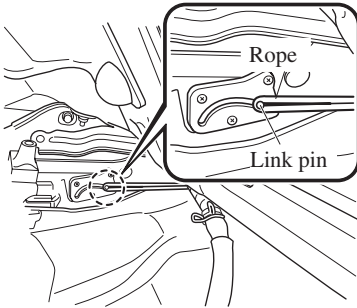

- If the rear roof is not locked completely, the trunk will not open even if the remote release button, the electric trunk lid opener, or the trunk button on the transmitter is operated.
6. Do the same procedure on the other side.
 7. Open the trunk and tie the rope to the trunk hinge.

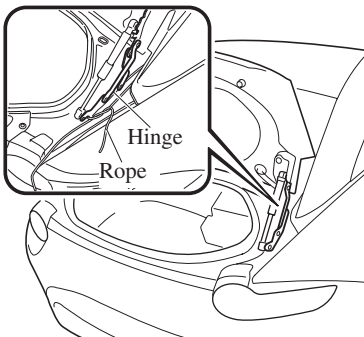

8. Tie off the other side rope the same way.
9. Close the trunk lid.

After finishing the procedure

After finishing the procedure, have the roof checked at an Authorized Mazda Dealer as soon as possible.

! WARNING

Drive the vehicle at a speed of 40 km/h (24 mph) or lower before having the roof checked at an Authorized Mazda Dealer:

The front roof may open while the vehicle is being driven and cause an accident.

MEMO

Important consumer information including warranties and add-on equipment.

Customer Assistance	8-2	Recording of Vehicle Data	8-21
Customer Assistance (U.S.A.)	8-2	Recording of Vehicle Data	8-21
Customer Assistance (Canada)	8-6	Uniform Tire Quality Grading System (UTQGS)	8-22
Customer Assistance (Puerto Rico)	8-9	Uniform Tire Quality Grading System (UTQGS)	8-22
Customer Assistance (Mexico)	8-10	Tire Information (U.S.A.)	8-24
Mazda Importer/Distributors	8-12	Tire Labeling	8-24
Importer/Distributor	8-12	Location of the Tire Label (Placard)	8-30
Reporting Safety Defects	8-13	Tire Maintenance	8-33
Reporting Safety Defects (U.S.A.)	8-13	Vehicle Loading	8-36
Reporting Safety Defects (Canada)	8-14	Steps for Determining the Correct Load Limit	8-42
Warranty	8-15	Declaration of Conformity	8-43
Warranties for Your Mazda	8-15	Declaration of Conformity	8-43
Outside the United States/Canada	8-16		
Registering Your Vehicle in A Foreign Country (Except United States and Canada)	8-17		
Add-On Non-Genuine Parts and Accessories	8-18		
Cell Phones	8-19		
Cell Phones Warning	8-19		
Event Data Recorder	8-20		
Event Data Recorder (U.S.A. and Canada)	8-20		

Customer Assistance

Customer Assistance (U.S.A.)

Your complete and permanent satisfaction is our business. We are here to serve you. All Authorized Mazda Dealers have the knowledge and the tools to keep your Mazda vehicle in top condition.

If you have any questions or recommendations for improvement regarding the service of your Mazda vehicle or servicing by Mazda Dealer personnel, we recommend that you take the following steps:

NOTE

If it becomes necessary to have the components or wiring system for the supplementary restraint system modified to accommodate a person with certain medical conditions in accordance with a certified physician, contact an Authorized Mazda Dealer. For more information, go to NHTSA website www.safercar.gov (VEHICLE SHOPPERS > Air Bags > Air Bag FAQs > Air Bag Deactivation).

▼STEP 1: Contact Your Mazda Dealer

Discuss the matter with an Authorized Mazda Dealer. This is the quickest and best way to address the issue.

- If your concern has not been resolved by the CUSTOMER RELATIONS, SALES, SERVICE, or PARTS MANAGER, then please contact the GENERAL MANAGER of the dealership or the OWNER.
- If it becomes necessary to have the components or wiring system for the supplementary restraint system modified to accommodate a person with certain medical conditions in accordance with a certified physician, go to STEP 2.

▼STEP 2: Contact Mazda North American Operations

If for any reason you feel the need for further assistance after contacting your dealership management or it becomes necessary to have the components or wiring system for the supplementary restraint system modified to accommodate a person with certain medical conditions in accordance with a certified physician, you can reach Mazda North American Operations by one of the following ways.

Log on: at www.MazdaUSA.com

Answers to many questions, including how to locate or contact a local Mazda dealership in the U.S., can be found here.

E-mail: click on “Contact Us” located on the “Inside Mazda” tab, or at the bottom of the page at www.MazdaUSA.com

By phone at: 1 (800) 222-5500

By letter at:

Attn: Customer Assistance
Mazda North American Operations
7755 Irvine Center Drive
Irvine, CA 92618-2922
P.O. Box 19734
Irvine, CA 92623-9734

In order to serve you efficiently and effectively, please help us by providing the following information:

1. Your name, address, and telephone number
2. Year and model of vehicle
3. Vehicle Identification Number (17 digits, noted on your registration or title or located on the upper driver's side corner of the dash)
4. Purchase date and current mileage
5. Your dealer's name and location
6. Your question(s)

If you live outside the U.S.A., please contact your nearest Mazda Distributor.

▼STEP 3: Contact Better Business Bureau (BBB)

Mazda North American Operations realizes that mutual agreement on some issues may not be possible. As a final step to ensure that your concerns are being fairly considered, Mazda North American Operations has agreed to participate in a dispute settlement program administered by the Better Business Bureau (BBB) system, at no cost to you the consumer.

BBB AUTO LINE works with consumers and the manufacturer in an attempt to reach a mutually acceptable resolution of any warranty related concerns. If the BBB is not able to facilitate a settlement they will provide an informal hearing before an arbitrator.

You are required to resort to BBB AUTO LINE before exercising rights or seeking remedies under the Federal Magnuson-Moss Warranty Act, 15 U.S.C. § 2301 et seq. To the extent permitted by the applicable state "Lemon Law", you are also required to resort to BBB AUTO LINE before exercising any rights or seeking remedies under the "Lemon Law". If you choose to seek remedies that are not created by the Magnuson-Moss Warranty Act or the applicable state "Lemon Law", you are not required to first use BBB AUTO LINE.

The whole process normally takes 40 days or less. The arbitration decision is not binding on you or Mazda unless you accept the decision. For more information about BBB AUTO LINE, including current eligibility standards, please call 1-800-955-5100 or visit the BBB website at www.bbb.org/autoline.

Customer Assistance

Being truly committed to customer satisfaction is more than a phrase with Mazda. We hope to satisfy every customer directly, but if there is ever a question about our decision, Mazda believes in providing a fast, fair and free method such as the BBB AUTO LINE to ensure Mazda delivers on our commitment to do the right thing for our customers!

▼ California Customers

1. Mazda North American Operations participates in BBB AUTO LINE, a mediation/arbitration program administered by the Council of Better Business Bureaus [4200 Wilson Boulevard, Arlington, Virginia 22203] through local Better Business Bureaus. BBB AUTO LINE and Mazda have been certified by the Arbitration Certification Program of the California Department of Consumer Affairs.
2. If you have a problem arising under a Mazda written warranty, we encourage you to bring it to our attention. If we are unable to resolve it, you may file a claim with BBB AUTO LINE. Claims must be filed with BBB AUTO LINE within six (6) months after the expiration of the warranty.
3. To file a claim with BBB AUTO LINE, call 1-800-955-5100. There is no charge for the call.
4. In order to file a claim with BBB AUTO LINE, you will have to provide your name and address, the brand name and vehicle identification number (VIN) of your vehicle, and a statement of the nature of your problem or complaint. You will also be asked to provide: the approximate date of your acquisition of the vehicle, the vehicle's current mileage, the approximate date and mileage at the time any problem(s) were first brought to the attention of Mazda or one of our dealers, and a statement of the relief you are seeking.
5. BBB AUTO LINE staff may try to help resolve your dispute through mediation. If mediation is not successful, or if you do not wish to participate in mediation, claims within the program's jurisdiction may be presented to an arbitrator at an informal hearing. The arbitrator's decision should ordinarily be issued within 40 days from the time your complaint is filed; there may be a delay of 7 days if you did not first contact Mazda about your problem, or a delay of up to 30 days if the arbitrator requests an inspection/report by an impartial technical expert or further investigation and report by BBB AUTO LINE.
6. You are required to use BBB AUTO LINE before asserting in court any rights or remedies conferred by California Civil Code Section 1793.22. You are also required to use BBB AUTO LINE before exercising rights or seeking remedies created by Title I of the Magnuson-Moss Warranty Act, 15 U.S.C. sec. 2301 et seq. If you choose to seek redress by pursuing rights and remedies not created by California Civil Code Section 1793.22 or Title I of the Magnuson-Moss Warranty Act, resort to BBB AUTO LINE is not required by those statutes.

7. California Civil Code Section 1793.2 (d) requires that, if Mazda or its representative is unable to repair a new motor vehicle to conform to the vehicle's applicable express warranty after a reasonable number of attempts, Mazda may be required to replace or repurchase the vehicle. California Civil Code Section 1793.22 (b) creates a presumption that Mazda has had a reasonable number of attempts to conform the vehicle to its applicable express warranties if, within 18 months from delivery to the buyer or 18,000 miles on the vehicle's odometer, whichever occurs first, one or more of the following occurs:
- The same nonconformity [a failure to conform to the written warranty that substantially impairs the use, value or safety of the vehicle] results in a condition that is likely to cause death or serious bodily injury if the vehicle is driven **AND** the nonconformity has been subject to repair two or more times by Mazda or its agents **AND** the buyer or lessee has directly notified Mazda of the need for the repair of the nonconformity; OR
 - The same nonconformity has been subject to repair 4 or more times by Mazda or its agents **AND** the buyer has notified Mazda of the need for the repair of the nonconformity; OR
 - The vehicle is out of service by reason of repair of nonconformities by Mazda or its agents for a cumulative total of more than 30 calendar days after delivery of the vehicle to the buyer.

NOTICE TO Mazda AS REQUIRED ABOVE SHALL BE SENT TO THE FOLLOWING ADDRESS:

Mazda North American Operations
7755 Irvine Center Drive
Irvine, CA 92618
ATTN: Customer Mediation

8. The following remedies may be sought in BBB AUTO LINE: repairs, reimbursement for money paid to repair a vehicle or other expenses incurred as result of a vehicle nonconformity, repurchase or replacement of your vehicle, and compensation for damages and remedies available under Mazda's written warranty or applicable law.
9. The following remedies may **not** be sought in BBB AUTO LINE: punitive or multiple damages, attorneys' fees, or consequential damages other than as provided in California Civil Code Section 1794 (a) and (b).
10. You may reject the decision issued by a BBB AUTO LINE arbitrator. If you reject the decision, you will be free to pursue further legal action. The arbitrator's decision and any findings will be admissible in a court action.
11. If you accept the arbitrator's decision, Mazda will be bound by the decision, and will comply with the decision within a reasonable time not to exceed 30 days after we receive notice of your acceptance of the decision.
12. Please call BBB AUTO LINE at 1-800-955-5100 for further details about the program.

Customer Assistance

Customer Assistance (Canada)

▼ Satisfaction Review Process

Your complete and permanent satisfaction is of primary concern to Mazda. All Authorized Mazda Dealers have both the knowledge and tools to keep your Mazda in top condition. In our experience, any questions, problems, or complaints regarding the operation of your Mazda or any other general service transactions are most effectively resolved by your dealer. If the cause of your dissatisfaction cannot adequately be addressed by normal dealership procedures, we recommend that you take the following steps:

▼ STEP 1: Contact the Mazda Dealer

Discuss the matter with a member of dealership management. If the Service Manager has already reviewed your concerns, contact the owner of the dealership or its General Manager.

▼ STEP 2: Contact the Mazda Regional Office

If you feel that you still require assistance, ask the dealer Service Manager to arrange for you to meet the local Mazda Service Representative. If more expedient, contact Mazda Canada Inc. Regional Office nearest you for such arrangements. Regional Office address and phone numbers are shown (page 8-8).

▼ STEP 3: Contact the Mazda Customer Relations Department

If still not substantially satisfied, contact the Customer Relations Department, Mazda Canada Inc., 55 Vogell Road, Richmond Hill, Ontario, L4B 3K5 Canada TEL: 1 (800) 263-4680.

Provide the Department with the following information:

1. Your name, address and telephone number
2. Year and model of vehicle
3. Vehicle Identification Number (VIN). Refer to the Vehicle Identification Number on page 9-2 for the location of the VIN.
4. Purchase date
5. Present odometer reading
6. Your dealer's name and location
7. The nature of your problem and/or cause of dissatisfaction

The Department, in cooperation with the local Mazda Service Representative, will review the case to determine if everything possible has been done to ensure your satisfaction.

Please recognize that the resolution of service problems in most cases requires the use of your Mazda dealer's service facilities, personnel and equipment. We urge you to follow the above three steps in sequence for most effective results.

▼ **Mediation/Arbitration Program**

Occasionally a customer concern cannot be resolved through Mazda's Customer Satisfaction Program. If after exhausting the procedures in this manual your concern is still not resolved, you have another option.

Mazda Canada Inc. participates in an arbitration program administered by the Canadian Motor Vehicle Arbitration Plan (CAMVAP). CAMVAP will advise you about how your concern may be reviewed and resolved by an independent third party through binding arbitration.

Your complete satisfaction is the goal of Mazda Canada Inc. and our dealers. Mazda's participation in CAMVAP makes a valuable contribution to our achieving that goal. There is no charge for using CAMVAP. CAMVAP results are fast, fair and final as the award is binding on both you and Mazda Canada Inc.

▼ **Canadian Motor Vehicle Arbitration Plan (CAMVAP)**

If a specific item of concern arises, where a solution cannot be reached between an owner, Mazda, and/or one of its dealers (that all parties cannot agree upon), the owner may wish to use the services offered by the Canadian Motor Vehicle Arbitration Plan (CAMVAP).

CAMVAP uses the services of Provincial Administrators to assist consumers in scheduling and preparing for their arbitration hearings. However, before you can proceed with CAMVAP you must follow your Mazda dispute resolution process as outlined previously.

CAMVAP is fully implemented in all provinces and territories.

Consumers wishing to obtain further information about the Program should contact the Provincial Administrator at 1 (800) 207-0685, or by contacting the Canadian Motor Vehicle Arbitration Plan Office at:

Canadian Motor Vehicle Arbitration Plan
235 Yorkland Boulevard, suite 300
North York, Ontario
M2J 4Y8
<http://camvap.ca>

Customer Assistance

Provincial Administrators may be reached locally:

Province/Territory	CAMVAP Number
British Columbia & Yukon Territories	1 (800) 207-0685
Alberta & Northwest Territories	1 (800) 207-0685
Saskatchewan	1 (800) 207-0685
Manitoba	1 (800) 207-0685
Ontario	1 (800) 207-0685
Atlantic Canada	1 (800) 207-0685
Quebec	1 (800) 207-0685

▼ Regional Offices

REGIONAL OFFICES	COVERING AREAS
MAZDA CANADA INC. WESTERN REGION 5011 275 STREET LANGLEY, BRITISH COLUMBIA V4W 0A8 (778) 369-2100 1 (800) 663-0908	ALBERTA, BRITISH COLUMBIA, MANITOBA, SASKATCHEWAN, YUKON
MAZDA CANADA INC. CENTRAL REGION 55 VOGELL ROAD, RICHMOND HILL, ONTARIO, L4B 3K5 1 (800) 263-4680	ONTARIO, NEW BRUNSWICK, NOVA SCOTIA, PRINCE EDWARD ISLAND, NEWFOUNDLAND
MAZDA CANADA INC. QUEBEC REGION 6111 ROUTE TRANSCANADIENNE POINTE CLAIRE, QUEBEC H9R 5A5 (514) 694-6390	QUEBEC

Customer Assistance (Puerto Rico)

Your complete and permanent satisfaction is our business. That is why all Authorized Mazda Dealers have the knowledge and the tools to keep your Mazda vehicle in top condition. If you have any questions or recommendations for improvement regarding the service of your Mazda vehicle or servicing by Mazda Dealer personnel, we recommend that you take the following steps:

▼ STEP 1

Discuss the matter with an Authorized Mazda Dealer. This is the quickest and best way to address the issue. If your concern has not been resolved by the CUSTOMER RELATIONS, SALES, SERVICE, or PARTS MANAGER, then please contact the GENERAL MANAGER of the dealership or the OWNER.

▼ STEP 2

If, after following STEP 1, you feel the need for further assistance, please contact your area's Mazda representative.
Refer to Importer/Distributor on page 8-12.

Please help us by providing the following information:

1. Your name, address, and telephone number
2. Year and model of vehicle
3. Vehicle Identification Number (17 digits, noted on your registration or title or located on the upper driver's side corner of the dash)
4. Purchase date and current mileage
5. Your dealer's name and location
6. Your question(s)

Customer Assistance

Customer Assistance (Mexico)

Your complete and permanent satisfaction is our business. We are here to serve you. All Authorized Mazda Dealers have the knowledge and the tools to keep your Mazda vehicle in top condition.

If you have any questions or recommendations for improvement regarding the service of your Mazda vehicle or servicing by Mazda Dealer personnel, we recommend that you take the following steps:

▼ Contact Your Mazda Dealer

Discuss the matter with an Authorized Mazda Dealer. This is the quickest and best way to address the issue.

- If your concern has not been resolved by the CUSTOMER RELATIONS, SALES, SERVICE, or PARTS MANAGER, then please contact the GENERAL MANAGER of the dealership or the OWNER.
- If it becomes necessary to have the components or wiring system for the supplementary restraint system modified to accommodate a person with certain medical condition in accordance with a certified physician you must contact your dealership in order to avoid the potential loss of the warranty of your vehicle which may occur if some third party is hired by the customer to make any modifications to this system.

Log on: at www.mazdamexico.com.mx

Answers to many questions, including how to locate or contact a local Mazda dealership in Mexico, can be found here.

E-mail: click on “Contactanos” at the top of the page at www.mazdamexico.com.mx

By phone at: 01 800 01 MAZDA (62932)

By letter at:

Attn: Customer Assistance
Mazda Motor de Mexico
Mario Pani #150, PB Col. Lomas de Santa Fe
Mexico, D.F. C.P. 05300
Del. Cuajimalpa de Morelos
Tel: Customer Assistance
01 800 01 MAZDA(62932).

Customer Assistance

In order to serve you efficiently and effectively, please help us by providing the following information:

1. Your name, address, and telephone number
2. Year and model of vehicle
3. Vehicle Identification Number (17 digits, noted on your registration or title or located on the upper driver's side corner of the dash)
4. Purchase date and current mileage
5. Your dealer's name and location
6. Your question(s)

Mazda Importer/Distributors

Importer/Distributor

▼ U.S.A.

Mazda North American Operations

7755 Irvine Center Drive
Irvine, CA 92618-2922 U.S.A.

P.O. Box 19734

Irvine, CA 92623-9734 U.S.A.

TEL: 1 (800) 222-5500 (in U.S.A.)
(949) 727-1990 (outside U.S.A.)

▼ CANADA

Mazda Canada Inc.

55 Vogell Road, Richmond Hill,
Ontario, L4B 3K5 Canada

TEL: 1 (800) 263-4680 (in Canada)
(905) 787-7000 (outside Canada)

▼ PUERTO RICO/U.S. Virgin Island

International Automotive Distributor Group, LLC. (Mazda de Puerto Rico)

P.O. Box 191850, San Juan, Puerto Rico
00919-1850

TEL: (787) 641-1777

▼ MEXICO

Mazda Motor de Mexico

Mario Pani # 150, PB Col. Lomas de
Santa Fe Mexico, D.F. C.P. 05300 Del.
Cuajimalpa

TEL: Center of Attention to Clients:
01 (800) 016 2932. in Mexico

▼ GUAM

Triple J Motors

157 South Marine Drive, Tamuning,
GUAM 96911 USA

P.O. Box 6066 Tamuning, Guam 96931
TEL: (671) 649-6555

▼ SAIPAN

Pacific International Marianas, Inc. (d.b.a. Midway Motors)

P.O. Box 887 Saipan, MP 96950
TEL: (670) 234-7524

Triple J Saipan, Inc.

(d.b.a. Triple J Motors)

P.O. Box 500487 Saipan, MP 96950-0487
TEL: (670) 234-7133/3051

▼ AMERICAN SAMOA

Polynesia Motors, Inc.

P.O. Box 1120, Pago Pago, American
Samoa 96799

TEL: (684) 699-9347

Reporting Safety Defects (U.S.A.)

If you believe that your vehicle has a defect which could cause a crash or could cause injury or death, you should immediately inform the National Highway Traffic Safety Administration (NHTSA) in addition to notifying Mazda Motor Corporation (Your Mazda Importer/Distributor).

If NHTSA receives similar complaints, it may open an investigation, and if it finds that a safety defect exists in a group of vehicles, it may order a recall and remedy campaign. However, NHTSA cannot become involved in individual problems between you, your dealer, or Mazda Motor Corporation (Your Mazda Importer/Distributor).

To contact NHTSA, you may call the Vehicle Safety Hotline toll-free at 1-888-327-4236 (TTY:1-800-424-9153); go to <http://www.safercar.gov>; or write to: Administrator, NHTSA, 1200 New Jersey Avenue, SE., Washington, DC, 20590. You can also obtain other information about motor vehicle safety from <http://www.safercar.gov>.

NOTE

If you live in the U.S.A., all correspondence to Mazda Motor Corporation should be forwarded to:

*Mazda North American Operations
7755 Irvine Center Drive
Irvine, California 92618-2922*

or

P.O. Box 19734

Irvine, CA 92623-9734

Customer Experience Center or toll free at 1 (800) 222-5500

If you live outside of the U.S.A., please contact the nearest Mazda Distributor shown (page 8-12) in this manual.

Reporting Safety Defects

Reporting Safety Defects (Canada)

Canadian customers who wish to report a safety-related defect to Transport Canada, Defect Investigations and Recalls, may telephone the toll free hotline 1-800-333-0510, or contact Transport Canada by mail at: Transport Canada, ASFAD, Place de Ville Tower C, 330 Sparks Street, Ottawa ON K1A 0N5.

For additional road safety information, please visit the Road Safety website at:
<http://www.tc.gc.ca/roadsafety/menu.htm>

Warranties for Your Mazda

- New Vehicle Limited Warranty
- Powertrain Limited Warranty
- Safety Restraint System Limited Warranty
- Anti-perforation Limited Warranty
- Federal Emission Control Warranty/California Emission Control Warranty
 - Emission Defect Warranty
 - Emission Performance Warranty
- Emission Control Warranty
- Replacement Parts and Accessories Limited Warranty
- Tire Warranty

NOTE

Warranty information varies depending on the country. Refer to the Warranty Booklet for detailed warranty information.

Warranty

Outside the United States/Canada

Government regulations in the United States/Canada require that automobiles meet specific emission regulations and safety standards. Therefore, vehicles built for use in the United States/Canada may differ from those sold in other countries.

The differences may make it difficult or even impossible for your vehicle to receive satisfactory servicing in other countries. We strongly recommend that you NOT take your Mazda outside the United States/Canada.

United States

However, in the event that you are moving to Canada permanently, Mazda vehicles built for use in the United States could be eligible for exportation to Canada with specific vehicle modifications to comply with the Canadian Motor Vehicle Safety Standards (CMVSS).

Canada

However, in the event that you are moving to the United States permanently, Mazda vehicles built for use in Canada could be eligible for exportation to the United States with specific vehicle modifications to comply with the United States Federal Motor Vehicle Safety Standards (FMVSS).

NOTE

The above is applicable for a permanent import/export situation and not related to travelers on vacation.

You may have the following problems if you do take your vehicle outside of the United States/Canada:

- Recommended fuel may be unavailable. Any kind of leaded fuel or low-octane fuel will affect vehicle performance and damage the emission controls and engine.
- Proper repair facilities, tools, testing equipment, and replacement parts may not be available.

Please refer to your Manufacturer's Warranty Booklet for more information.

Registering Your Vehicle in A Foreign Country (Except United States and Canada)

Registering your vehicle in a foreign country may be problematic depending on whether it meets the specific emission and safety standards of the country in which the vehicle will be driven. Consequently, your vehicle may require modifications at personal expense in order to meet the regulations.

In addition, you should be aware of the following issues:

Satisfactory vehicle servicing may be difficult or impossible in another country.

The fuel specified for your vehicle may be unavailable.

Parts, servicing techniques, and tools necessary to maintain and repair your vehicle may be unavailable.

There might not be an Authorized Mazda Dealer in the country you plan to take your vehicle.

The Mazda warranty is valid only in certain countries.

Warranty

Add-On Non-Genuine Parts and Accessories

Non-genuine parts and accessories for Mazda vehicles can be found in stores. These may fit your vehicle, but they are not approved by Mazda for use with Mazda vehicles. When you install non-genuine parts or accessories, they could affect your vehicle's performance or safety systems; the Mazda warranty doesn't cover this. Before you install any non-genuine parts or accessories, consult an Authorized Mazda Dealer.

WARNING

Always consult an Authorized Mazda Dealer before you install non-genuine parts or accessories:

Improperly designed parts or accessories could seriously affect your vehicle's performance or safety systems. This could cause you to have an accident or increase your chances of injuries in an accident.

Be very careful in choosing and installing add-on electrical equipment, such as mobile telephones, two-way radios, stereo systems, and car alarm systems:

Incorrectly choosing or installing improper add-on equipment or choosing an improper installer is dangerous. Essential systems could be damaged, causing engine stalling, air-bag (SRS) activation, ABS/TCS/DSC inactivation, or a fire in the vehicle.

Mazda assumes no responsibility for death, injury, or expenses that may result from the installation of add-on non-genuine parts or accessories.

Cell Phones Warning

WARNING

Please comply with the legal regulations concerning the use of communication equipment in vehicles in your country:

Use of any electrical devices such as cell phones, computers, portable radios, vehicle navigation or other devices by the driver while the vehicle is moving is dangerous. Dialing a number on a cell phone while driving also ties-up the driver's hands. Use of these devices will cause the driver to be distracted and could lead to a serious accident. If a passenger is unable to use the device, pull off the right-of-way to a safe area before use. If use of a cell phone is necessary despite this warning, use a hands-free system to at least leave the hands free to drive the vehicle. Never use a cell phone or other electrical devices while the vehicle is moving and, instead, concentrate on the full-time job of driving.

Event Data Recorder

Event Data Recorder (U.S.A. and Canada)

This vehicle is equipped with an event data recorder (EDR). The main purpose of an EDR is to record, in certain crash or near crash-like situations, such as an air bag deployment or hitting a road obstacle, data that will assist in understanding how a vehicle's systems performed. The EDR is designed to record data related to vehicle dynamics and safety systems for a short period of time, typically 30 seconds or less. The EDR in this vehicle is designed to record such data as:

- How various systems in your vehicle were operating;
- Whether or not the driver and passenger safety belts were buckled/fastened;
- How far (if at all) the driver was depressing the accelerator and/or brake pedal; and,
- How fast the vehicle was traveling.

These data can help provide a better understanding of the circumstances in which crashes and injuries occur.

NOTE:

EDR data are recorded by your vehicle only if a non-trivial crash or near crash-like situation occurs; no data are recorded by the EDR under normal driving conditions and no personal data (e.g., name, gender, age, and crash location) are recorded. However, other parties, such as law enforcement, could combine the EDR data with the type of personally identifying data routinely acquired during a crash investigation.

To read data recorded by an EDR, special equipment is required, and access to the vehicle or the EDR is needed. In addition to the vehicle manufacturer, other parties, such as law enforcement, that have the special equipment, can read the information if they have access to the vehicle or the EDR.

Mazda will not disclose any of the data recorded in an EDR to a third party unless:

- A written agreement from the vehicle owner or the lessee is obtained
- Officially requested by the police or other law enforcement authorities
- Used as a defense for Mazda in a law suit, claim, or arbitration
- Ordered by a judge or court

However, if necessary Mazda will:

- Use the data for research on Mazda vehicle performance, including safety.
- Disclose the data or the summarized data to a third party for research purposes without disclosing vehicle or owner identification information.

Recording of Vehicle Data

This vehicle is equipped with a computer which records the following main vehicle data related to vehicle controls, operation, and other driving conditions.

Recorded data

- Vehicle conditions such as engine speed and vehicle speed
- Driving operation conditions such as accelerator and brake pedals, and information related to the environmental circumstances while the vehicle is driven
- Malfunction diagnosis information from each on-vehicle computer
- Information related to controls of other on-vehicle computers

NOTE

The recorded data may vary depending on the vehicle grade and optional equipment. Voice and images are not recorded.

Data handling

Mazda and its subcontracting parties may obtain and use the recorded data for vehicle malfunction diagnosis, research and development, and quality improvement.

Mazda will not disclose or provide any of the obtained data to a third party unless:

- An agreement from the vehicle owner (agreements from lessor and lessee for leased vehicle) is obtained
- Officially requested by the police or other law enforcement authorities
- For statistical processing by a research institution after processing the data so that identification of the owner or the vehicle is impossible

Uniform Tire Quality Grading System (UTQGS)

Uniform Tire Quality Grading System (UTQGS)

This information relates to the tire grading system developed by the U.S. National Highway Traffic Safety Administration for grading tires by tread wear, traction, and temperature performance.

▼ Tread Wear

The tread wear grade is a comparative rating based on the wear rate of the tire when tested under controlled conditions on a specified government test course.

For example, a tire graded 150 would wear one-and-a-half times as well on the government course as a tire graded 100.

The relative performance of tires depends upon the actual conditions of their use, however, and may depart significantly from the norm because of variations in driving habits, service practices and differences in road characteristics and climate.

▼ Traction-AA, A, B, C

The traction grades, from highest to lowest, are AA, A, B, and C. These grades represent the tire's ability to stop on wet pavement as measured under controlled conditions on specified government test surfaces of asphalt and concrete. A tire marked C may have poor traction performance.

WARNING

The traction grade assigned to this tire is based on braking (straight ahead) traction tests and does not include acceleration cornering (turning), hydroplaning, or peak traction characteristics.

▼ Temperature-A, B, C

The temperature grades A (the highest), B, and C, represent the tire's resistance to the generation of heat and its ability to dissipate heat when tested under controlled conditions on a specified indoor laboratory test wheel.

Sustained high temperature can cause the material of the tire to degenerate and reduce tire life, and excessive temperatures can lead to sudden tire failure.

Grade C corresponds to a level of performance which all passenger vehicle tires must meet under the Federal Motor Vehicle Safety Standard No. 109. Grades B and A represent higher levels of performance on the laboratory test wheel than the minimum required by law.

Uniform Tire Quality Grading System (UTQGS)

⚠ WARNING

Keep your vehicle's tires properly inflated and not overloaded:

Driving with improperly inflated or overloaded tires is dangerous. Excessive speed, underinflation, or excessive loading, either separately or in combination, can cause heat buildup and possible tire failure. The temperature grade for this tire is established for a tire that is properly inflated and not overloaded.

These grades will be added to the sidewalls of passenger vehicle tires over the next several years according to a schedule established by the NHTSA and the tire manufacturers.

The grade of tires available as standard or optional equipment on Mazda vehicles may vary with respect to grade.

ALL PASSENGER VEHICLE TIRES MUST CONFORM TO THESE GRADES AND TO ALL OTHER FEDERAL TIRE-SAFETY REQUIREMENTS.

▼ UNIFORM TIRE QUALITY GRADING

Quality grades can be found where applicable on the tire sidewall between tread shoulder and maximum section width.

For example:

TREADWEAR 200 TRACTION AA TEMPERATURE A

UTQGS MARK (example)

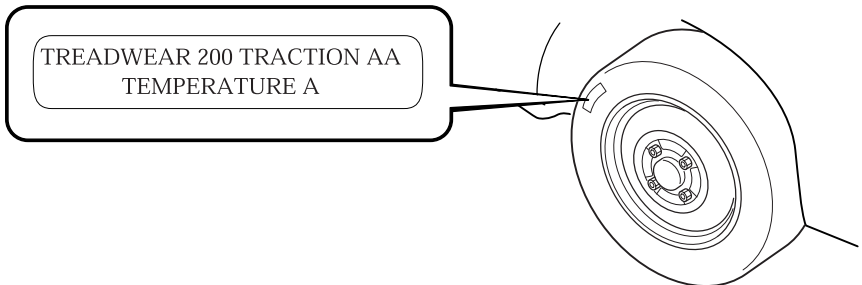

Tire Information (U.S.A.)

Tire Labeling

Federal law requires tire manufacturers to place standardized information on the sidewall of all tires. This information identifies and describes the fundamental characteristics of the tire and also provides a tire identification number for safety standard certification and in case of a recall.

▼ Information on Passenger Vehicle Tires

Please refer to the sample below.

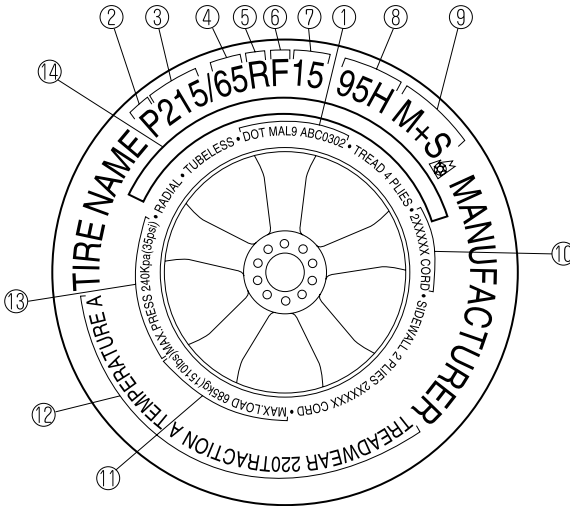

1. TIN: U.S. DOT tire identification number
2. Passenger car tire
3. Nominal width of tire in millimeters
4. Ratio of height to width (aspect ratio)
5. Radial
6. Run-flat tire
7. Rim diameter code
8. Load index & speed symbol
9. Severe snow conditions
10. Tire ply composition and materials used
11. Max. load rating
12. Tread wear, traction and temperature grades
13. Max. permissible inflation pressure
14. SAFETY WARNING

P215/65R15 95H is an example of a tire size and load index rating. Here is an explanation of the various components of that tire size and load index rating. Note that the tire size and load index rating may be different from the example.

P

Indicates a tire that may be installed on cars, SUVs, minivans and light trucks as designated by the Tire and Rim Association (T&RA).

NOTE

If your tire size does not begin with a letter this may mean it is designated by either ETRTO (European Tire and Rim Technical Organization) or JATMA (Japan Tire Manufacturing Association).

215

“215” is the nominal width of the tire in millimeters. This three-digit number gives the width in millimeters of the tire from sidewall edge to sidewall edge. In general, the larger the number, the wider the tire.

65

“65” is the aspect ratio. This two-digit number indicates the tire's ratio of height to width.

R

“R” is the tire construction symbol. R indicates “Radial ply construction”.

15

“15” is the wheel rim diameter in inches.

95

“95” is the Load Index. This two-or three-digit number indicates how much weight each tire can support.

Tire Information (U.S.A.)

H

“H” is the speed rating. The speed rating denotes the maximum speed for which the use of the tire is rated.

Letter Rating	Speed Rating
Q	99 mph
R	106 mph
S	112 mph
T	118 mph
U	124 mph
H	130 mph
V	149 mph
W	168* mph
Y	186* mph

* For tires with a maximum speed capability over 149 mph, tire manufacturers sometimes use the letters ZR. For tires with a maximum speed capability over 186 mph, tire manufacturers always use the letters ZR.

M+S or M/S: Mud and Snow

AT: All Terrain.

AS: All Season. The “M+S” or “M/S” indicates that the tire has some functional use in mud and snow.

U.S. DOT Tire Identification Number (TIN)

This begins with the letters “DOT” which indicates the tire meets all federal standards. The next two numbers or letters are the plant code where it was manufactured, and the last four numbers represent the week and year the tire was manufactured. For example, the numbers 457 means the 45th week of 1997. After 2000 the numbers go to four digits. For example, the number 2102 means the 21th week of 2002. The other numbers are marketing codes used at the manufacturer's discretion. This information is used to contact consumers if a tire defect requires a recall.

Tire Ply Composition and Materials Used

The number of plies indicates the number of layers of rubber-coated fabric in the tire. In general, the greater the number of plies, the more weight a tire can support. Tire manufacturers also must indicate the tire materials, which include steel, nylon, polyester, and other.

Maximum Load Rating

This number indicates the maximum load in kilograms and pounds that can be carried by the tire.

Maximum Permissible Inflation Pressure

This number is the greatest amount of air pressure that should ever be put in the tire under normal driving conditions.

Tread Wear, Traction and Temperature Grades

Tread wear: The tread wear grade is a comparative rating based on the wear rate of the tire when tested under controlled conditions on a specified government test course. For example, a tire graded 150 would wear one and one-half (1 1/2) times as well on the government course as a tire graded 100.

Traction: The traction grades, from highest to lowest are AA, A, B, and C. The grades represent the tire's ability to stop on wet pavement as measured under controlled conditions on specified government test surfaces of asphalt and concrete. A tire marked C may have poor traction performance.

Temperature: The temperature grades are A (the highest), B and C, representing the tire's resistance to the generation of heat and its ability to dissipate heat when tested under controlled conditions on a specified indoor laboratory test wheel.

Snow Tires

In some heavy snow areas, local governments may require true snow tires, those with very deeply cut tread. These tires should only be used in pairs or placed on all four wheels. Make sure you purchase snow tires that are the same size and construction type as the other tires on your vehicle.

SAFETY WARNING

The following safety warning appears on the tire's sidewall.
SERIOUS INJURY MAY RESULT FROM:

- EXPLOSION OF TIRE/RIM ASSEMBLY DUE TO IMPROPER MOUNTING-MATCH TIRE DIAMETER TO RIM DIAMETER; NEVER EXCEED 40 psi (275 kPa) TO SEAT BEADS-ONLY SPECIALLY TRAINED PERSONS SHOULD MOUNT TIRES.
- TIRE FAILURE DUE TO UNDER-INFLATION/OVERLOADING/DAMAGE-FOLLOW OWNER'S MANUAL AND PLACARD IN VEHICLE-FREQUENTLY CHECK INFLATION PRESSURE AND INSPECT FOR DAMAGE.

Tire Information (U.S.A.)

▼ Information on Temporary Tires

Please refer to the sample below.

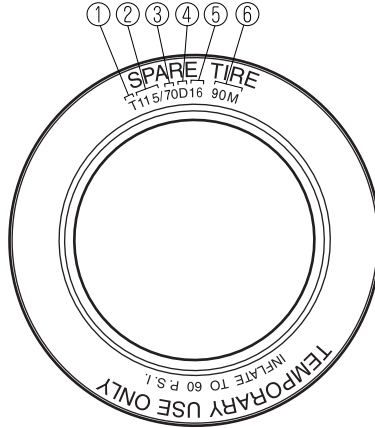

1. Temporary tires
2. Nominal width of tire in millimeters
3. Ratio of height to width (aspect ratio)
4. Diagonal
5. Rim diameter code
6. Load index & speed symbol

T115/70D16 90M is an example of a tire size and load index rating. Here is an explanation of the various components of that tire size and load index rating. Note that the tire size and load index rating may be different from the example.

T

Indicates a tire that may be installed on cars, SUVs, minivans and light trucks as designated by the Tire and Rim Association (T&RA).

115

“115” is the nominal width of the tire in millimeters. This three-digit number gives the width in millimeters of the tire from sidewall edge to sidewall edge. In general, the larger the number, the wider the tire.

70

“70” is the aspect ratio. This two-digit number indicates the tire's ratio of height to width.

D

“D” is the tire construction symbol. D indicates “diagonal ply construction”.

Tire Information (U.S.A.)

16

“16” is the wheel rim diameter in inches.

90

“90” is the Load Index. This two-or three-digit number indicates how much weight each tire can support.

M

“M” is the speed rating. The speed rating denotes the maximum speed for which the use of the tire is rated.

Letter Rating	Speed Rating
M	81 mph

Tire Information (U.S.A.)

Location of the Tire Label (Placard)

You will find the tire label containing tire inflation pressure by tire size and other important information on the driver's side B-pillar or on the edge of the driver's door frame.

SAMPLE



TIRE AND LOADING INFORMATION RENSEIGNEMENTS SUR LES PNEUS ET LE CHARGEMENT			
SEATING CAPACITY NOMBRE DE PLACES	TOTAL 5	FRONT AVANT 2	REAR ARRIÈRE 3
The combined weight of occupants and cargo should never exceed xxx kg or xxx lbs.* Le poids total des occupants et du chargement ne doit jamais dépasser xxx kg ou xxx lb.*			
TIRE PNEU	SIZE DIMENSIONS	COLD TIRE PRESSURE PRESSION DES PNEUS À FROID	SEE OWNER'S MANUAL FOR ADDITIONAL INFORMATION
FRONT AVANT	P195/70R14	200 kPa, 29 psi	VOIR LE MANUEL DE L'USAGER POUR PLUS DE RENSEIGNEMENTS
REAR ARRIÈRE	P195/70R14	200 kPa, 29 psi	
SPARE DE SECOURS	T125/70D15	420 kPa, 60 psi	

▼ Recommended Tire Inflation Pressure

On the tire label you will find the recommended tire inflation pressure in both kPa and psi for the tires installed as original equipment on the vehicle. It is very important that the inflation pressure of the tires on your vehicle is maintained at the recommended pressure. You should check the tire pressure regularly to insure that the proper inflation pressure is maintained.

Refer to Tires on page 9-8.

NOTE

Tire pressures listed on the vehicle placard or tire information label indicate the recommended cold tire inflation pressure, measured when the tires are cold, after the vehicle has been parked for at least 3 hours. As you drive, the temperature in the tire warms up, increasing the tire pressure.

 WARNING

Always check the tire inflation pressures on a regular basis according to the recommended tire inflation pressure on the tire label and in conjunction with the information in this owner's manual:

Driving your vehicle with under-inflated tires is dangerous.

Under-inflation is the most common cause of failures in any kind of tire and may result in severe cracking, tread separation or "blowout", with unexpected loss of vehicle control and increased risk of injury. Under-inflation increases sidewall flexing and rolling resistance, resulting in heat buildup and internal damage to the tire. It results in unnecessary tire stress, irregular wear, loss of control and accidents. A tire can lose up to half of its air pressure and not appear to be flat!

It is impossible to determine whether or not tires are properly inflated just by looking at them.

▼ Checking Tire Pressure

1. When you check the air pressure, make sure the tires are cold —meaning they are not hot from driving even a mile.
2. Remove the cap from the valve on one tire.
3. Firmly press a tire gauge onto the valve.
4. Add air to achieve recommended air pressure.
5. If you overfill the tire, release air by pushing on the metal stem in the center of the valve. Then recheck the pressure with your tire gauge.
6. Replace the valve cap.
7. Repeat with each tire, including the spare.

NOTE

Some spare tires require higher inflation pressure.

8. Visually inspect the tires to make sure there are no nails or other objects embedded that could poke a hole in the tire and cause an air leak.
9. Check the sidewalls to make sure there are no gouges, cuts, bulges, cracks or other irregularities.

Tire Information (U.S.A.)

▼ Glossary of Terms

Tire Placard: A label indicating the OE tire sizes, recommended inflation pressure, and the maximum weight the vehicle can carry.

Tire Identification Number (TIN): A number on the sidewall of each tire providing information about the tire brand and manufacturing plant, tire size, and date of manufacture.

Inflation Pressure: A measure of the amount of air in a tire.

kPa: Kilopascal, the metric unit for air pressure.

psi: Pounds per square inch, the English unit for air pressure.

B-pillar: The structural member at the side of the vehicle behind the front door.

Original Equipment (OE): Describes components originally equipped on the vehicle.

Vehicle Load Limit: The maximum value of the combination weight of occupants and cargo.

Bead Area of the Tire: Area of the tire next to the rim.

Sidewall Area of the Tire: Area between the bead area and the tread.

Tread Area of the Tire: Area on the perimeter of the tire that contacts the road when it's mounted on the vehicle.

Seating capacity means the total allowable number of vehicle occupants. Seating capacity is described on the tire label.

Production options weight is the combination weight of installed regular production options weighing over 2.3 kilograms in excess of the standard items which they replace, and not previously considered in the curb weight or accessory weight, including heavy duty brakes, ride levelers, roof rack, heavy duty battery, and special trim.

Rim is the metal support (wheel) for a tire or a tire and tube assembly upon which the tire beads are seated.

Tire Maintenance

Improper or inadequate vehicle maintenance can cause tires to wear abnormally. Here are some important maintenance points:

▼ Tire Inflation Pressure

Inspect all tire pressure monthly (including the spare) when the tires are cold. Maintain recommended pressures for the best ride, top handling, and minimum tire wear. Use the pressures specified on the vehicle tire information placard or tire label for optimum service.

▼ Tire Rotation

To equalize tread wear, rotate the tires every 12,000 km (7,500 miles) at the latest or sooner if irregular wear develops. Mazda recommends to rotate every 8,000 km (5,000 miles) to help increase tire life and distribute wear more evenly.

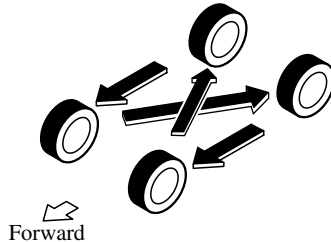

Do not include (TEMPORARY USE ONLY)
spare tire in rotation.

Inspect the tires for uneven wear and damage. Abnormal wear is usually caused by one or a combination of the following:

- Incorrect tire pressure
- Improper wheel alignment
- Out-of-balance wheel
- Severe braking

After rotation, inflate all tire pressures to specification (page 9-8) and inspect the lug nuts for tightness.

(With tire pressure monitoring system)

After adjusting the tire pressure, initialization of the tire pressure monitoring system is necessary to make the system operate normally.

Refer to Tire Pressure Monitoring System Initialization on page 4-108.

Tire Information (U.S.A.)

CAUTION

Rotate unidirectional tires and radial tires that have an asymmetrical tread pattern or studs only from front to rear, not from side to side. Tire performance will be weakened if rotated from side to side.

(With limited-slip differential)

Don't use the following:

- Tires not of the designated size
- Tires of different sizes or types at the same time
- Tires not sufficiently inflated

If these instructions aren't followed, the rotation of the left and right wheels will be different and will thus apply a constant load on the limited-slip differential. This will cause a malfunction.

▼ Replacing a Tire

WARNING

Always use tires that are in good condition:

Driving with worn tires is dangerous. Reduced braking, steering, and traction could result in an accident.

If a tire wears evenly, a wear indicator will appear as a solid band across the tread. Replace the tire when this happens.

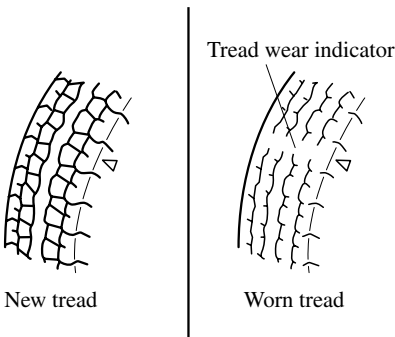

You should replace the tire before the band crosses the entire tread.

(With tire pressure monitoring system)

After adjusting the tire pressure, initialization of the tire pressure monitoring system is necessary to make the system operate normally.

Refer to Tire Pressure Monitoring System Initialization on page 4-108.

NOTE

Tires degrade over time, even when they are not being used on the road. It is recommended that tires generally be replaced when they are 6 years or older. Heat caused by hot climates or frequent high loading conditions can accelerate the aging process. The period in which the tire was manufactured (both week and year) is indicated by a 4-digit number. Refer to Tire Labeling on page 8-24.

▼ Safety Practices

The way you drive has a great deal to do with your tire mileage and safety. So cultivate good driving habits for your own benefit.

- Observe posted speed limits and drive at speeds that are safe for the existing weather conditions
- Avoid fast starts, stops and turns
- Avoid potholes and objects on the road
- Do not run over curbs or hit the tire against the curb when parking

 CAUTION

If you feel a sudden vibration or ride disturbance while driving or you suspect your tire or vehicle has been damaged, immediately reduce your speed. Drive with caution until you can safely pull off the road. Stop and inspect the tire for damage. If the tire is under-inflated or damaged, deflate it, remove the tire and rim and replace it with your spare tire. If you cannot detect a cause, have the vehicle towed to the nearest vehicle or tire dealer to have the vehicle inspected.

Vehicle Loading

WARNING

Do not tow a trailer with this vehicle:

Towing a trailer with this vehicle is dangerous because it has not been designed to tow a trailer and doing so will affect the drive system which could result in vehicle damage.

This section will guide you in the proper loading of your vehicle, to keep your loaded vehicle weight within its design rating capability. Properly loading your vehicle will provide maximum return of vehicle design performance. Before loading your vehicle, familiarize yourself with the following terms for determining your vehicle's weight ratings, from the vehicle's Safety Certification Label and Tire and Load Information Label:

WARNING

Overloaded Vehicle:

Overloading a vehicle is dangerous. The results of overloading can have serious consequences in terms of passenger safety. Too much weight on a vehicle's suspension system can cause spring or shock absorber failure, brake failure, handling or steering problems, irregular tire wear, tire failure or other damage.

Overloading makes a vehicle harder to drive and control. It also increases the distance required for stopping. In cases of serious overloading, brakes can fail completely, particularly on steep grades. The load a tire will carry safely is a combination of the size of the tire, its load range, and corresponding inflation pressure.

Never overload the vehicle and always observe the vehicle's weight ratings from the vehicle's Safety Certification and Tire and Load Information labels.

Tire Information (U.S.A.)

Base Curb Weight is the weight of the vehicle including a full tank of fuel and all standard equipment. It does not include passengers, cargo, or optional equipment.

Vehicle Curb Weight is the weight of your new vehicle when you picked it up from your dealer plus any aftermarket equipment.

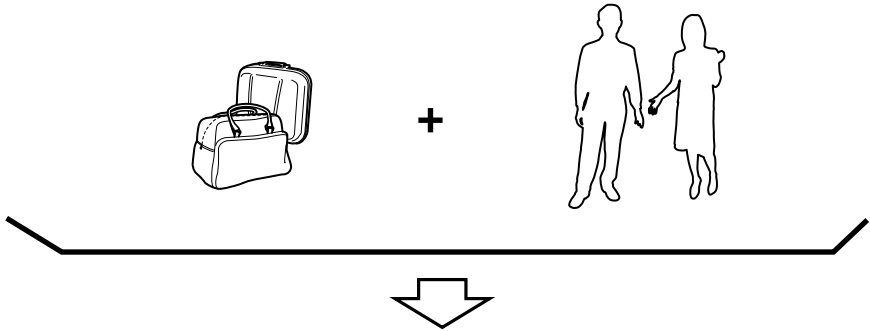

PAYLOAD

Payload is the combination weight of cargo and passengers that the vehicle is designed to carry. The maximum payload for your vehicle can be found on the Tire and Load Information label on the driver's door frame or door pillar. Look for "THE COMBINATION WEIGHT OF OCCUPANTS AND CARGO SHOULD NEVER EXCEED XXX kg or XXX lbs" for your maximum payload. The payload listed on the tire label is the maximum payload for the vehicle as built by the assembly plant. If any aftermarket or dealer installed equipment has been installed on the vehicle, the weight of the equipment must be subtracted from the payload listed on the tire label in order to be accurate.

Tire Information (U.S.A.)

SAMPLE



TIRE AND LOADING INFORMATION
RENSEIGNEMENTS SUR LES PNEUS ET LE CHARGEMENT

SEATING CAPACITY NOMBRE DE PLACES	TOTAL 5	FRONT AVANT 2	REAR ARRIÈRE 3
--------------------------------------	---------	------------------	-------------------

The combined weight of occupants and cargo should never exceed **xxx** kg or **xxx** lbs.*
 Le poids total des occupants et du chargement ne doit jamais dépasser **xxx** kg ou **xxx** lb.*

TIRE PNEU	SIZE DIMENSIONS	COLD TIRE PRESSURE PRESSION DES PNEUS À FROID	SEE OWNER'S MANUAL FOR ADDITIONAL INFORMATION
FRONT AVANT	P195/70R14	200 kPa, 29 psi	VOIR LE MANUEL DE L'USAGER POUR PLUS DE RENSEIGNEMENTS
REAR ARRIÈRE	P195/70R14	200 kPa, 29 psi	
SPARE DE SECOURS	T125/70D15	420 kPa, 60 psi	





CARGO

Cargo Weight includes all weight added to the Base Curb Weight, including cargo and optional equipment.

The cargo weight limit decreases depending on the number of vehicle occupants. The cargo weight limit can be calculated by subtracting the total weight of the vehicle occupants from the “combination weight of occupants and cargo should never exceed” value on the tire label.

Examples: Based on a single occupant weight of 68 kg (150 lbs), and a value of 385 kg (849 lbs) for the “combination weight of occupants and cargo should never exceed”:

The cargo weight limit with one occupant is $385 \text{ kg (849 lbs)} - 68 \text{ kg (150 lbs)} = 317 \text{ kg (699 lbs)}$

The cargo weight limit with two occupants is $385 \text{ kg (849 lbs)} - (68 \times 2) \text{ kg } ((150 \times 2) \text{ lbs}) = 249 \text{ kg (549 lbs)}$

If the weight of the occupant increases, the cargo weight limit decreases by that much.

GAW (Gross Axle Weight) is the total weight placed on each axle (front and rear) - including vehicle curb weight and all payload.

GAWR (Gross Axle Weight Rating) is the maximum allowable weight that can be carried by a single axle (front or rear). **These numbers are shown on the Safety Compliance Certification Label located on the driver's door frame or door pillar. The total load on each axle must never exceed its GAWR.**

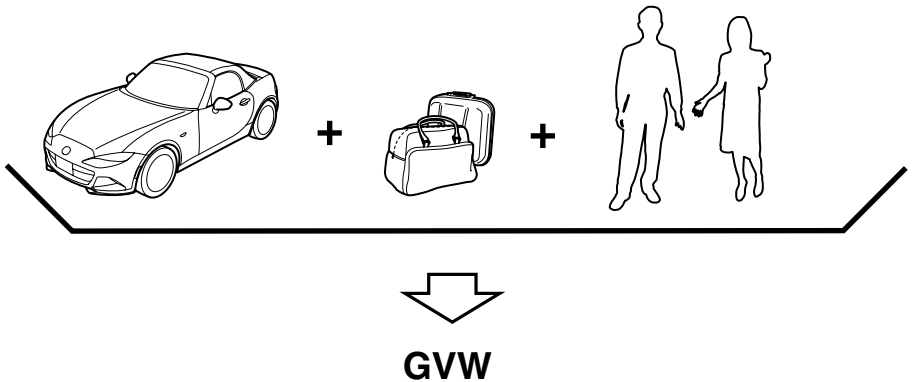

GVW (Gross Vehicle Weight) is the Vehicle Curb Weight + cargo + passengers.

GVWR (Gross Vehicle Weight Rating) is the maximum allowable weight of the fully loaded vehicle (including all options, equipment, passengers and cargo). **The GVWR is shown on the Safety Compliance Certification Label located on the driver's door frame or door pillar. The GVW must never exceed the GVWR.**

GCW (Gross Combination Weight) is the weight of the loaded vehicle (GVW).

GCWR (Gross Combination Weight Rating) is the maximum allowable weight of the vehicle - including all cargo and passengers - that the vehicle can handle without risking damage. **The GCW must never exceed the GCWR.**

 WARNING

Never Exceed GVWR or GAWR Specifications:

Exceeding the GVWR or the GAWR specified on the certification label is dangerous. Exceeding any vehicle rating limitation could result in a serious accident, injury, or damage to the vehicle.

Do not use replacement tires with lower load carrying capacities than the originals because they may lower the vehicle's GVWR and GAWR limitations. Replacement tires with a higher limit than the originals do not increase the GVWR and GAWR limitations. Never exceed the GVWR or the GAWR specified on the certification label.

Tire Information (U.S.A.)

Steps for Determining the Correct Load Limit

Steps for Determining Correct Load Limit-

- (1) Locate the statement “The combined weight of occupants and cargo should never exceed XXX kg or XXX lbs.” on your vehicle's placard.
- (2) Determine the combined weight of the driver and passengers that will be riding in your vehicle.
- (3) Subtract the combined weight of the driver and passengers from XXX kg or XXX lbs.
- (4) The resulting figure equals the available amount of cargo and luggage load capacity. For example, if the “XXX” amount equals 1400 lbs. and there will be five 150 lb passengers in your vehicle, the amount of available cargo and luggage load capacity is 650 lbs.
($1400 - 750 (5 \times 150) = 650$ lbs.)
- (5) Determine the combined weight of luggage and cargo being loaded on the vehicle. That weight may not safely exceed the available cargo and luggage load capacity calculated in Step 4.
- (6) If your vehicle will be towing a trailer, load from your trailer will be transferred to your vehicle. Consult this manual to determine how this reduces the available cargo and luggage load capacity of your vehicle.

Declaration of Conformity

▼ Keyless Entry System/Immobilizer System

FCC WARNING

Changes or modifications not expressly approved by the party responsible for compliance could void the user's authority to operate the equipment.

FCC/IC

This device complies with Part 15 of FCC Rules and Industry Canada licence-exempt RSS standard(s). Operation is subject to the following two conditions: (1) this device may not cause interference, and (2) this device must accept any interference, including interference that may cause undesired operation of this device.

Le présent appareil est conforme aux la Partie 15 des règles de la FCC et CNR d'Industrie Canada applicables aux appareils radio exempts de licence. L'exploitation est autorisée aux deux conditions suivantes: (1) l'appareil ne doit pas produire de brouillage, et (2) l'utilisateur de l'appareil doit accepter tout brouillage radioélectrique subi, même si le brouillage est susceptible d'en compromettre le fonctionnement.

(MEXICO)

La operación de este equipo está sujeta a las siguientes dos condiciones: (1) es posible que este equipo o dispositivo no cause interferencia perjudicial y (2) este equipo o dispositivo debe aceptar cualquier interferencia, incluyendo la que pueda causar su operación no deseada.

Declaration of Conformity

▼ Blind Spot Monitoring (BSM) System

(U.S.A.)

FCC ID : NBG012692A

This device complies with part 15 of the FCC Rules. Operation is subject to the following two conditions:

- (1) This device may not cause harmful interference, and
- (2) this device must accept any interference received, including interference that may cause undesired operation.

FCC Warning

Changes or modifications not expressly approved by the party responsible for compliance could void the user's authority to operate the equipment.

(Canada)

This Category II radiocommunication device complies with Industry

Canada Standard RSS-310.

Ce dispositif de radiocommunication de catégorie II respecte la norme CNR-310 d'Industrie Canada .

This device complies with Industry Canada licence-exempt RSS standard(s).

Operation is subject to the following two conditions:

- (1) this device may not cause interference, and (2) this device must accept any interference, including interference that may cause undesired operation of the device.

Le présent appareil est conforme aux CNR d'Industrie Canada applicables aux appareils radio exempts de licence. L'exploitation est autorisée aux deux conditions suivantes:

- (1) l'appareil ne doit pas produire de brouillage, et (2) l'utilisateur de l'appareil doit accepter tout brouillage radioélectrique subi, même si le brouillage est susceptible d'en compromettre le fonctionnement.

Mexico

Sistema de apertura de puertas de automóviles,

base y llave electrónica

Hella KGaA Hueck & Co

LCA3.5

COFETEL: RCPHEL15-0521

▼ **HomeLink Wireless Control System**

! CAUTION

HomeLink has been tested and complies with FCC and Industry Canada rules. Changes or modifications not expressly approved by the party responsible for compliance could void the user's authority to operate the device.

NOTE

FCC ID: NZLMOBHL4

CANADA: 4112A-MOBHL4

This device complies with part 15 of the FCC Rules. Operation is subject to the following two conditions:

- 1- This device may not cause harmful interference, and*
- 2- This device must accept any interference received, including interference that may cause undesired operation.*

▼ **Bluetooth® Hands-Free**

Type A

U.S.A. and Canada

Model: MAZ

Brand: **Johnson Controls Inc.**
915 E. 32nd St., Holland, MI
49423 Michigan
United States of America
MAZ

CE 0682

FCC ID: CB2MBLUEC09 IC:279B-MBLUEC09

This device complies with Part 15 of the FCC Rules and with RSS-210 of Industry Canada. Operation is subject to the following two conditions:

- (1) This device may not cause harmful interference, and
- (2) This device must accept any interference received, including interference that may cause undesired operation.

! WARNING

Changes or modifications not expressly approved by the party responsible for compliance could void the user's authority to operate the equipment.

Declaration of Conformity

The term "IC: " before the radio certification number only signifies that Industry Canada technical specifications were met.

The antenna used for this transmitter must not be co-located or operating in conjunction with any other antenna or transmitter. End-users and installers must be provided with installation instructions and transmitter operating conditions for satisfying RF exposure compliance.

Mazda Bluetooth® Hands-Free Customer Service

- U.S.A.
Phone: 800-430-0153 (Toll-free)
Web: www.mazdausa.com/mazdaconnect
- Canada
Phone: 800-430-0153 (Toll-free)
Web: www.mazdahandsfree.ca

Mexico

'Para cumplimiento de la Cofetel:

La operación de este equipo está sujeta a las siguientes dos condiciones:

(1) es posible que este equipo o dispositivo no cause interferencia perjudicial y
(2) este equipo o dispositivo debe aceptar cualquier interferencia, incluyendo la que pueda causar su operación no deseada"

- Brief description: Bluetooth module for Hands-free telephone and streaming audio
- Name and address of the importer: Refer to "MEXICO" (page 8-12) in Importer/Distributor section.
- Brand name of the product: Johnson Controls Inc.
- Model name of the product: MAZ
- Names and addresses of where the warranty can be served: Refer to "MEXICO" (page 8-12) in Importer/Distributor section.
- Names and addresses of where to acquire spare parts, consumables and accessories: Refer to "MEXICO" (page 8-12) in Importer/Distributor section.
- Warranty period, items covered by the warranty and its possible limitations or exceptions: Refer to the Warranty Booklet for detailed warranty information.
- Warranty procedure:
Center of Attention to Client (CAC)
Phone: 01-800-01-MAZDA
Web: www.mazdamexico.com.mx
- Electrical specifications:
Voltage: 9-16V, Frequency: 2.4Ghz, Current: 270mA(Typ)

Declaration of Conformity

Type B

U.S.A. and Canada

Type B – Model: MAZDA GEN 65 CMU

FCC ID: CB262932 IC: 279B-62932

FCC/IC Regulatory Notice

Modification statement

Johnson Controls Interiors LLC has not approved any changes or modifications to this device by the user. Any changes or modifications could void the user's authority to operate the equipment.

Johnson Controls Interiors LLC n'approuve aucune modification apportée à l'appareil par l'utilisateur, quelle qu'en soit la nature. Tout changement ou modification peuvent annuler le droit d'utilisation de l'appareil par l'utilisateur.

Interference statement

This device complies with Part 15 of the FCC Rules and Industry Canada licence-exempt RSS standard(s). Operation is subject to the following two conditions: (1) this device may not cause interference, and (2) this device must accept any interference, including interference that may cause undesired operation of the device.

Le présent appareil est conforme aux CNR d'Industrie Canada applicables aux appareils radio exempts de licence. L'exploitation est autorisée aux deux conditions suivantes : (1) l'appareil ne doit pas produire de brouillage, et (2) l'utilisateur de l'appareil doit accepter tout brouillage radioélectrique subi, même si le brouillage est susceptible d'en compromettre le fonctionnement.

Radiation Exposure Statement

This device complies with FCC/IC radiation exposure limits set forth for an uncontrolled environment and meets the FCC radio frequency (RF) Exposure Guidelines in Supplement C to OET65 and RSS-102 of the IC radio frequency (RF) Exposure rules. The antenna should be installed and operated with minimum distance of 20 cm between the radiator and your body. This transmitter must not be co-located or operating in conjunction with any other antenna or transmitter.

Le présent appareil est conforme à l'exposition aux radiations FCC / IC définies pour un environnement non contrôlé et répond aux directives d'exposition de la fréquence de la FCC radiofréquence (RF) dans le Supplément C à OET65 et RSS-102 de la fréquence radio (RF) IC règles d'exposition. L'antenne doit être installée de façon à garder une distance minimale de 20 centimètres entre la source de rayonnements et votre corps. L'émetteur ne doit pas être colocalisé ni fonctionner conjointement avec à autre antenne ou autre émetteur.

Declaration of Conformity

Mexico



RCPJOMA13-1301

9

Specifications

Technical information about your Mazda.

Identification Numbers	9-2
Vehicle Information Labels.....	9-2
Specifications	9-4
Specifications	9-4
Personalization Features	9-9
Personalization Features	9-9

Identification Numbers

Vehicle Information Labels

▼ Vehicle Identification Number

The vehicle identification number legally identifies your vehicle. The number is on a plate attached to the cowl panel located on the left corner of the dashboard. This plate can easily be seen through the windshield.

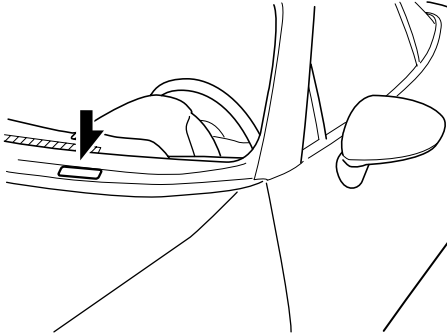

▼ Motor Vehicle Safety Standard Label (U.S.A. and Canada)

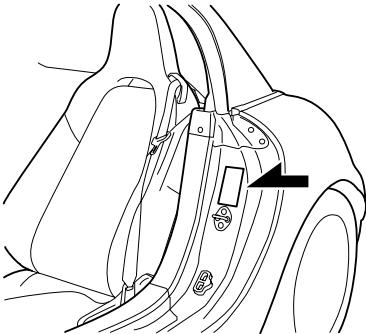

▼ Chassis Number

Open the cover shown in the figure to check the chassis number.

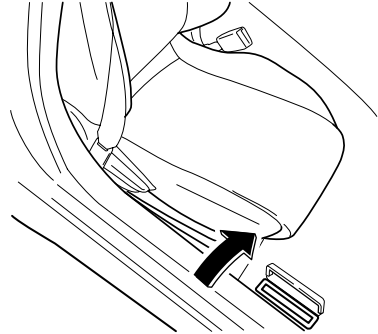

▼ Vehicle Emission Control Information Label (U.S.A. and Canada)

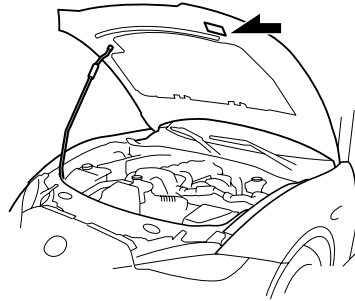

▼ Tire Pressure Label

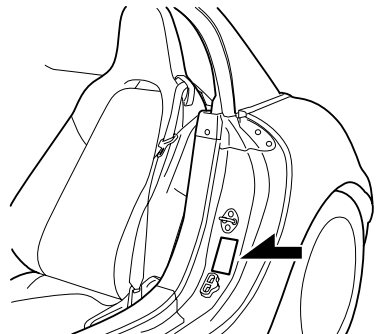

▼ Engine Number

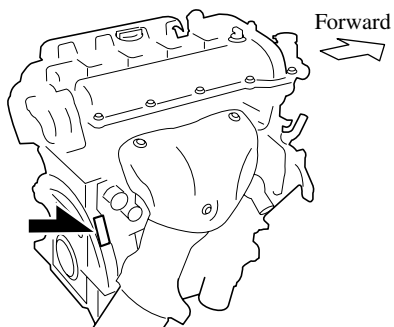

Specifications

Specifications

▼ Engine

Item	Specification
Type	DOHC-16V in-line, 4-cylinder
Bore × Stroke	83.5 × 91.2 mm (3.29 × 3.59 in)
Displacement	1,997.6 ml (1,997.6 cc)
Compression ratio	13.0

▼ Electrical System

Item	Classification
Battery	12V-45Ah/20HR
Spark-plug number	Mazda Genuine spark plug* ¹ PE5R-18-110 or PE5S-18-110

*1 The spark plugs provide the SKYACTIV-G its optimum performance. Consult an Authorized Mazda Dealer for details.

CAUTION

When cleaning the iridium plugs, do not use a wire brush. The fine particulate coating on the iridium alloy and platinum tips could be damaged.

▼ Lubricant Quality

Lubricant	Classification
Engine oil	Refer to Recommended Oil on page 6-27.
Coolant	FL-22 type
Manual transmission oil	Mazda Original Long Life Gear Oil IS* ¹
Automatic transmission fluid	Mazda Genuine JWS3309
Rear differential oil	Mazda Long Life Hypoid Gear Oil SG1
Brake/Clutch fluid	SAE J1703 or FMVSS116 DOT-3

*1 Mazda Original Long Life Gear Oil IS is superior oil for optimum shift-feel. Using Mazda Original Long Life Gear Oil IS is recommended.

If Mazda Original Long Life Gear Oil IS cannot be obtained, use standard oil (API Service GL-4 (SAE 75W-90)). However, shifting in very low temperatures may become difficult.

NOTE

Refer to Introduction on (page 6-2) for owner's responsibility in protecting your investment.

▼ Capacities**(Approximate Quantities)**

Item		Capacity
Engine oil	With oil filter replacement	4.3 L (4.5 US qt, 3.8 Imp qt)
	Without oil filter replacement	4.1 L (4.3 US qt, 3.6 Imp qt)
Coolant	Manual transmission	6.0 L (6.3 US qt, 5.3 Imp qt)
	Automatic transmission	5.9 L (6.2 US qt, 5.2 Imp qt)
Manual transmission oil		2.0 L (2.1 US qt, 1.8 Imp qt)
Automatic transmission fluid		7.2 L (7.6 US qt, 6.3 Imp qt)
Rear differential oil		0.6 L (0.6 US qt, 0.5 Imp qt)
Fuel tank		45.0 L (11.9 US gal, 9.90 Imp gal)

Check oil and fluid levels with dipsticks or reservoir gauges.

▼ Dimensions**U.S.A. and Canada**

Item	Vehicle specification	
	Soft top model	Retractable fastback model
Overall length	3,915 mm (154.1 in)	3,915 mm (154.1 in)
Overall width	1,735 mm (68.3 in)	1,735 mm (68.3 in)
Overall height	16 inch wheel vehicle	—
	17 inch wheel vehicle	1,245 mm (49.0 in)
Front tread	1,495 mm (58.9 in)	1,495 mm (58.9 in)
Rear tread	1,505 mm (59.3 in)	1,505 mm (59.3 in)
Wheelbase	2,310 mm (90.9 in)	2,310 mm (90.9 in)

Mexico

Item	Vehicle specification	
	Soft top model	Retractable fastback model
Overall length	3,915 mm (154.1 in)	3,915 mm (154.1 in)
Overall width	1,735 mm (68.3 in)	1,735 mm (68.3 in)
Overall height	16 inch wheel vehicle	—
	17 inch wheel vehicle	1,235 mm (48.6 in)
Front tread	1,495 mm (58.9 in)	1,495 mm (58.9 in)
Rear tread	1,505 mm (59.3 in)	1,505 mm (59.3 in)
Wheelbase	2,310 mm (90.9 in)	2,310 mm (90.9 in)

Specifications

▼ Weights

U.S.A. and Canada

Item		Indication on display			
		Soft top model		Retractable fastback model	
		Manual transmission	Automatic transmission	Manual transmission	Automatic transmission
GVWR (Gross Vehicle Weight Rating)		1,245 kg (2,745 lbs)	1,265 kg (2,789 lbs)	1,298 kg (2,862 lbs)	1,312 kg (2,892 lbs)
GAWR (Gross Axle Weight Rating)	Front	628 kg (1,384 lbs)	642 kg (1,415 lbs)	636 kg (1,403 lbs)	644 kg (1,421 lbs)
	Rear	620 kg (1,367 lbs)	626 kg (1,380 lbs)	664 kg (1,465 lbs)	670 kg (1,477 lbs)

Mexico

Item		Indication on display	
		Soft top model	Retractable fastback model
GVW (Gross Vehicle Weight)	Total	1,242 kg (2,738 lbs)	1,305 kg (2,877 lbs)
	Front	627 kg (1,382 lbs)	639 kg (1,409 lbs)
	Rear	615 kg (1,356 lbs)	666 kg (1,468 lbs)
GAW (Permissible axle load)	Front	630 kg (1,389 lbs)	630 kg (1,389 lbs)
	Rear	615 kg (1,356 lbs)	615 kg (1,356 lbs)

▼ Air Conditioner

The type of refrigerant used is indicated on a label attached to the inside of the engine compartment. Check the label before recharging the refrigerant. Refer to Climate Control System on page 5-2.

Item	Classification
Refrigerant Type	HFC134a (R-134a)

▼ Light Bulbs**Exterior light**

Light bulb		Category	
		Wattage	UNECE*1 (SAE)
Headlights	High beam	LED*2	— (—)
	Low beam	LED*2	— (—)
Daytime running lights	LED type	LED*2	— (—)
	Bulb type	21	W21W (7440)
Parking lights		LED*2	— (—)
Front side-marker lights		5	W5W (—)
Front turn signal lights		28/8	— (7444NA)
Side turn signal lights		5*3	WY5W (—)
High-mount brake light		LED*2	— (—)
Rear turn signal lights		21	WY21W (7443NA)
Rear side-marker lights		5	W5W (—)
Brake lights		LED*2	— (—)
Taillights		LED*2	— (—)
Reverse lights		21	W21W (7440)
License plate lights		5	W5W (—)

*1 UNECE stands for United Nations Economic Commission for Europe.

*2 LED is the abbreviation for Light Emitting Diode.

*3 Bulb replacement is not possible because it is built into the unit. Replace the unit.

Interior light

Light bulb	Category	
	Wattage	UNECE*1
Overhead light	10	—
Trunk light	5	—

*1 UNECE stands for United Nations Economic Commission for Europe.

Specifications

▼ Tires

NOTE

The tires have been optimally matched with the chassis of your vehicle.

When replacing tires, Mazda recommends that you replace tires of the same type originally fitted to your vehicle. For details, contact an Authorized Mazda Dealer.

Check the tire pressure label for tire size and inflation pressure.

Refer to Tire Inflation Pressure on page 6-41.

After adjusting the tire pressure, initialization of the tire pressure monitoring system is necessary to make the system operate normally.

Refer to Tire Pressure Monitoring System Initialization on page 4-108.

Standard tire

Tire size	Inflation pressure	
	Front	Rear
195/50R16 84V	200 kPa (2.0 bar, 29 psi)	200 kPa (2.0 bar, 29 psi)
205/45R17 84W	200 kPa (2.0 bar, 29 psi)	200 kPa (2.0 bar, 29 psi)

Lug nut tightening torque

When installing a tire, tighten the lug nut to the following torque.

108—147 N·m (12—14 kgf·m, 80—108 ft·lbf)

▼ Fuses

Refer to Fuses on page 6-54.

Personalization Features

Personalization Features

The following personalization features can be set or changed by the customer or an Authorized Mazda Dealer.

Personalization features and settings which can be changed differ depending on the market and specification.

Settings Change Method

① Settings can be changed by operating the center display screen.

A: Refer to Settings on page 5-53.

B: Refer to Fuel Economy Monitor on page 4-69.

② Settings can be changed by operating the vehicle switches.

C: Refer to Auto Lock/Unlock Function on page 3-15.

D: Refer to Transmitter on page 3-4.

E: Refer to Locking, Unlocking with Request Switch (With the advanced keyless function) on page 3-12.

F: Refer to Outside Temperature Display on page 4-15.

③ Settings can be changed by an Authorized Mazda Dealer.

Item	Feature	Factory Setting	Available Settings	Settings Change Method		
				①	②	③
Safety						
Lane Departure Warning System (LDWS) (page 4-79).	Distance by which the system uses to determine the possibility of a lane departure	Before	At/Before	A	—	×
	Warning sensitivity (likelihood of warning)	Low	High/Low	A	—	×
	Warning beep sound	Beep	Beep/Rumbl.	A	—	×
	Warning beep volume	Rumbl.	High	High/Mid/Low	A	—
Beep		High	High/Low	A	—	×
Blind Spot Monitoring (BSM) system (page 4-85).	Warning beep volume* ¹	High	High/Low/Off	A	—	×

Personalization Features

Item	Feature	Factory Setting	Available Settings	Settings Change Method		
				①	②	③
Vehicle						
Door locks (page 3-15).	Operation condition of auto lock/unlock function	Lock: When Driving Unlock: IGN Off	Lock: When Driving Unlock: In Park/ Lock: Out of Park Unlock: In Park/ Lock: Shifting Out of Park/ Lock: When Driving Unlock: IGN Off/ Lock: When Driving/ Off	A	C	×
Keyless entry system (page 3-3).	Method for unlocking door using transmitter	Driver's: Once, All Doors: Twice	All Doors: Once/ Driver's: Once, All Doors: Twice	A	D	×
	Time for locking door automatically	60 seconds	90 seconds/ 60 seconds/ 30 seconds	A	—	×
Advanced keyless entry system (page 3-8).	Method for unlocking door using request switch/transmitter	Driver's: Once, All Doors: Twice	All Doors: Once/ Driver's: Once, All Doors: Twice	A	D, E	×
	Time for locking door automatically	60 seconds	90 seconds/ 60 seconds/ 30 seconds	A	—	×
	Auto-lock function operation/non-operational	Off	On/Off	A	—	×
	Beep volume when locking/unlocking	Medium	High/ Medium/ Low/ Off	A	D, E	×
Illuminated entry system (page 5-133).	Time until interior lights turn off after closing door	15 seconds	60 seconds/ 30 seconds/ 15 seconds/ 7.5 seconds	A	—	×
	Time until interior lights turn off automatically when any door is not closed completely	30 minutes	60 minutes/ 30 minutes/ 10 minutes	A	—	×
Auto-wiper control (page 4-51).	Operational/non-operational	On	On/Off*2	A	—	×
Daytime running lights (page 4-49).	Operational/non-operational	On	On/Off	—	—	×

Personalization Features

Item	Feature	Factory Setting	Available Settings	Settings Change Method		
				①	②	③
Auto headlight off* ³ (page 4-45).	Time until headlights turn off	30 seconds	120 seconds/ 90 seconds/ 60 seconds/ 30 seconds/ Off* ⁴	A	—	×
Auto-light control (page 4-45).	Timing by which lights turn on	Medium	High/ Med. High/ Medium/ Med. Low/ Low	A	—	×
High Beam Control System (HBC) (page 4-76).	Operational/non-operational* ⁵	On	On/Off*	A	—	×
Adaptive Front Lighting System (AFS) (page 4-75).	Operational/non-operational* ⁵	On	On/Off*	A	—	×
Lights-on reminder* ⁶ (page 7-48).	Warning beep volume	Off	High/Low/Off	A	—	×
Coming home light (page 4-48).	Time until headlights turn off	30 seconds	120 seconds/ 90 seconds/ 60 seconds/ 30 seconds/ Off	A	—	×
Leaving home light (page 4-49).	Operational/non-operational	On	On/Off*	A	—	×
Turn indicator (page 4-50).	Beep volume	Low	High/Low	A	—	×
Three-flash turn signal (page 4-50).	Operational/non-operational	On	On/Off*	A	—	×
System						
Language	Language indicated in display	English	Depends on market* ⁷	A	—	×
Temperature	Temperature unit indicated in display	°F or °C	°F/°C	A	F	×
Distance	Distance unit indicated in display	mi or km	mi/km	A	—	×
Fuel Economy Monitor (page 4-69).						
Ending display	On/off	Off	On/Off*	B	—	×
Fuel economy resetting procedure	Linkage/non-linkage with fuel economy reset and trip meter A reset	Off	On/Off*	B	—	×

*1 Only the volume of the warning beep during Blind Spot Monitoring (BSM) operation can be changed. The volume of the warning beep during Rear Cross Traffic Alert (RCTA) operation cannot be changed.

*2 If the auto-wiper control is set to Off, the wiper lever **AUTO** position is set to intermittent operation.

Personalization Features

- *3 If the setting is changed to Off, the following operation is performed according to the headlight switch position:
 - At **AUTO** position: Headlights turn off immediately after the ignition is switched off.
 - At any position other than **AUTO**: Headlights on/off conditions vary according to the headlight switch position. Refer to Headlights on page 4-45
- *4 When set to Off, the lights-on reminder is operable.
- *5 Though these systems can be turned Off, doing so will defeat the purpose of the system and Mazda recommends that these systems remain On.
- *6 The setting of the lights-on reminder can be changed with the time setting of auto headlight off function set to Off.
Refer to Lights-On Reminder on page 7-48.
- *7 Available only in display from the center display.

10 Index

Index

A

- Accessory Socket 5-134
- Adaptive Front Lighting System (AFS)..... 4-75
- Add-On Non-Genuine Parts and Accessories 8-18
- Advanced Key
 - Advanced keyless entry system 3-8
 - Operational range 3-9
- Air Bag/Seat Belt Pretensioner System Warning Beep..... 7-48
- Air Bag Systems 2-24
- Ambient Temperature Display ... 4-15, 4-22
- Antilock Brake System (ABS)..... 4-65
- Audio Control Switch
 - Adjusting the volume 5-55
 - Seek switch..... 5-56
- Audio System..... 5-13
 - AUX/USB mode 5-57
 - Antenna 5-13
 - Audio control switch 5-55
 - Audio set
 - [Type A (non-touchscreen)]..... 5-22
 - Audio set
 - [Type B (touchscreen)] 5-34
 - Operating tips for audio system ... 5-14
 - Satellite radio 5-46
- Automatic Transmission 4-34
 - Active Adaptive Shift (AAS) 4-36
 - Direct mode 4-43
 - Driving tips..... 4-43
 - Manual shift mode..... 4-37
 - Shift-lock override 4-36
 - Shift-lock system..... 4-36
 - Shift position indication 4-35
 - Transmission ranges 4-35
 - Warning light..... 4-35

B

- Back Trim Storage Box..... 5-139
- Battery..... 6-36
 - Maintenance 6-38
 - Replacement..... 6-38
 - Specifications 9-4
- Battery Runs Out..... 7-23
 - Jump-starting..... 7-23
- Blind Spot Monitoring (BSM)..... 4-85
- Blind Spot Monitoring (BSM) System Warning Beep..... 7-51
- Bluetooth® 5-74
 - Bluetooth® audio (Type A)..... 5-113
 - Bluetooth® audio (Type B)..... 5-115
 - Bluetooth® Hands-Free (Type A)... 5-97
 - Bluetooth® Hands-Free (Type B)... 5-103
 - Troubleshooting 5-129
- Body Lubrication 6-32
- Brakes
 - Brakes assist..... 4-63
 - Foot brake..... 4-61
 - Pad wear indicator..... 4-62
 - Parking brake 4-62
 - Warning light..... 4-62
- Break-In Period..... 3-51

C

- Capacities..... 9-5
- Carbon Monoxide 3-24
- Cell Phones 8-19
- Child Restraint
 - Child-restraint precautions..... 2-15
 - Child-restraint system installation... 2-20
 - Installing child-restraint systems... 2-21
- Climate Control System..... 5-2
 - Fully automatic type..... 5-9
 - Gas specifications..... 9-6
 - Manual type..... 5-5
 - Operating tips 5-2
 - Vent operation 5-3
- Clock..... 5-26

Coming Home Light	4-48
Console Box.....	5-138
Convertible Top (Retractable Fastback)	3-39
Convertible Top (Soft Top)	3-34
Cruise Control	4-100
Cruise control switch.....	4-100
Cruise main indication (white)/ cruise set indication (green)	4-101
Cruise main indicator light (amber)/ cruise set indicator light (green)...	4-101
Cruise Control Set Vehicle Speed	
Display	4-16
Cup Holder.....	5-135
Customer Assistance	8-2

D

Dashboard Illumination	4-15
Daytime Running Lights.....	4-49
Defogger	
Mirror	4-56
Rear window	4-55
Dimensions	9-5
Door Locks.....	3-10
Drive Selection.....	4-71
Driving In Flooded Area	3-55
Driving Tips	
Automatic transmission.....	4-43
Break-in period.....	3-51
Driving in flooded area.....	3-55
Driving on uneven road.....	3-56
Floor mat	3-52
Hazardous driving	3-52
Overloading	3-55
Rocking the vehicle.....	3-53
Saving fuel and protection of the environment.....	3-51
Winter driving	3-53
Driving on Uneven Road	3-56

Dynamic Stability Control (DSC).....	4-67
DSC OFF indicator light	4-68
DSC OFF switch	4-68
TCS/DSC indicator light	4-67

E

Emergency Starting	
Push-starting.....	7-26
Starting a flooded engine.....	7-26
Emergency Towing	
Tiedown hooks	7-31
Towing description.....	7-30
Emission Control System.....	3-23
Ending Screen Display.....	4-70
Engine	
Coolant	6-29
Engine compartment overview	6-26
Exhaust gas.....	3-24
Hood release.....	6-24
Oil.....	6-27
Starting	4-5
Engine Coolant Temperature	
Gauge	4-13, 4-21
Essential Information	6-2
Event Data Recorder	8-20
Exhaust Gas	3-24
Exterior Care	6-59
Aluminum wheel maintenance.....	6-64
Bright-metal maintenance	6-63
Convertible Top (Retractable Fastback) Maintenance	6-66
Convertible Top (Soft Top) Maintenance	6-64
Maintaining the finish	6-61
Plastic part maintenance.....	6-68

Index

F

- Flasher
 - Hazard warning 4-57
 - Headlights 4-45
- Flat Tire 7-3
 - Mounting the tire 7-20
 - Removing a tire 7-16
- Floor Mat 3-52
- Fluid
 - Brake/Clutch 6-31
 - Washer 6-31
- Fluids
 - Classification 9-4
- Foot Brake 4-61
- Forward Sensing Camera (FSC) 4-95
- Fuel
 - Filler lid and cap 3-25
 - Gauge 4-14, 4-21
 - Requirements 3-22
 - Tank capacity 9-5
- Fuel Consumption Display 4-70
- Fuel Economy Monitor 4-69
 - Ending screen display 4-70
 - Fuel consumption display 4-70
- Fuel-Filler Lid
 - When fuel-filler lid cannot be opened 7-29
- Fuses 6-54
 - Panel description 6-56
 - Replacement 6-54

G

- Gauges 4-11

H

- Hazard Warning Flasher 4-57
- Hazardous Driving 3-52
- Head Restraint 2-6

Headlights

- Coming home light 4-48
- Control 4-45
- Flashing 4-48
- High-low beam 4-48
- Leaving home light 4-49
- Leveling 4-49
- High Beam Control System (HBC) 4-76
 - High Beam Control System (HBC) indicator light (green) 4-78
- Hill Launch Assist (HLA) 4-63
- HomeLink Wireless Control System 4-57
- Hood Release 6-24
- Horn 4-56

I

- i-ACTIVSENSE 4-74
 - Adaptive Front Lighting System (AFS) 4-75
 - Blind Spot Monitoring (BSM) 4-85
 - Camera and sensors 4-74
 - Forward Sensing Camera (FSC) 4-95
 - High Beam Control System (HBC) 4-76
 - Lane Departure Warning System (LDWS) 4-79
 - Radar sensors (rear) 4-98
 - Rear Cross Traffic Alert (RCTA) 4-92
- If a Warning Light Turns On or Flashes 7-33
- Ignition
 - Switch 4-4
- Ignition Not Switched Off (STOP) Warning Beep 7-49
- Illuminated Entry System 5-133
- Immobilizer System 3-47
- Indicator Lights 4-28
 - Low engine coolant temperature 4-30
 - Wrench 4-30
- Inside Trunk Release Lever 3-20
- Inspecting Brake/Clutch Fluid Level 6-31
- Inspecting Coolant Level 6-29

Inspecting Engine Oil Level	6-28
Inspecting Washer Fluid Level.....	6-31
Instrument Cluster.....	4-11
Interior Care.....	6-68
Cleaning the floor mats	6-71
Cleaning the window interiors	6-71
Instrument panel top maintenance...	6-70
Leather upholstery maintenance ...	6-69
Panel maintenance.....	6-70
Plastic part maintenance.....	6-70
Seat belt maintenance.....	6-68
Upholstery maintenance.....	6-69
Vinyl upholstery maintenance.....	6-69
Interior Lights	
Overhead light.....	5-132

J

Jack	7-4
Jump-Starting.....	7-23

K

Key Left-in-trunk Warning Beep (With the advanced keyless function).....	7-50
Key Left-in-vehicle Warning Beep (With the advanced keyless function)	7-50
Key Removed from Vehicle Warning Beep	7-50
Key Suspend Function	3-7
Keyless Entry System	3-3
Keys	3-2
Key suspend function.....	3-7
Transmitter	3-4

L

Label Information	9-2
Lane-Change Signals	4-50
Lane Departure Warning System (LDWS).....	4-79
LDWS switch.....	4-82
Lane Departure Warning sound	7-51

Leaving Home Light.....	4-49
Light Bulbs	
Replacement.....	6-45
Specifications	9-7
Lighting Control.....	4-45
Lights-on Reminder	7-48
Lubricant Quality	9-4

M

Maintenance	
Information.....	6-2
Scheduled	6-4
Maintenance Monitor.....	6-20
Manual Transmission Operation.....	4-31
Recommendations for shifting	4-33
Message Indicated in Multi-information Display	7-45
Message Indicated on Display	7-46
Meters and Gauges.....	4-11
Mirror Defogger.....	4-56
Mirrors	
Outside mirrors.....	3-28
Rearview mirror	3-29
Multi-information Display.....	4-18
Average fuel economy.....	4-23
Compass Display.....	4-24
Cruise control set vehicle speed display	4-24
Current fuel economy.....	4-23
Distance-to-empty	4-22
Engine Coolant Temperature Gauge	4-21
Fuel gauge	4-21
Lane Departure Warning System (LDWS) Display	4-24
Maintenance monitor	4-23
Odometer and trip meter	4-20
Outside temperature display.....	4-22
Retractable Fastback Operation Display	4-24
Warning (display indication).....	4-25

Index

O

- Odometer and Trip Meter..... 4-12, 4-20
- Outside Mirrors..... 3-28
- Outside Temperature Display..... 4-15, 4-22
- Overhead Light 5-132
- Overheating..... 7-27
- Overloading..... 3-55
- Owner Maintenance
 - Closing the hood 6-25
 - Engine compartment overview 6-26
 - Key battery replacement 6-38
 - Opening the hood 6-24
 - Owner maintenance precautions ... 6-22

P

- Parking Brake..... 4-62
- Personalization Features 9-9
- Power Steering..... 4-73
- Power Steering Warning Buzzer 7-50
- Power Windows 3-31

R

- Radar Sensors (Rear) 4-98
- Rear Cross Traffic Alert (RCTA) 4-92
- Rear Window Defogger 4-55
- Rearview Mirror..... 3-29
- Recommended Oil 6-27
- Recording of Vehicle Data 8-21
- Recreational Towing 3-57
- Registering Your Vehicle in A Foreign Country 8-17
- Replacement
 - Fuse 6-54
 - Key battery 6-38
 - Light bulbs 6-45
 - Tires..... 6-43
 - Wheel 6-43
 - Wiper..... 6-33
- Request Switch Inoperable Warning Beep (With the advanced keyless function)... 7-50

Retractable Fastback

- When the roof cannot be closed 7-57
- Retractable fastback warning beep 7-49
- Rocking the Vehicle 3-53

S

SRS Air Bags

- How the SRS air bags work 2-31
- Limitations to SRS air bag 2-35
- Monitoring..... 2-42
- Passenger occupant classification system..... 2-37
- SRS air bag deployment criteria ... 2-34
- Supplemental restraint system components 2-29
- Safety Defects, Reporting 8-13
- Satellite Radio..... 5-46
- Saving Fuel and Protection of the Environment..... 3-51
- Scheduled Maintenance 6-4
- Seat..... 2-4
- Seat Belt System 2-10
 - 3-point type 2-10
 - Automatic locking..... 2-9
 - Emergency locking..... 2-9
 - Extender 2-13
 - Pregnant women..... 2-9
 - Seat belt precautions 2-7
- Seat Belt Warning Beep 7-49
- Seat Side Box..... 5-138
- Seats
 - Head restraint 2-6
 - Seat warmer..... 2-5
- Security System
 - Immobilizer system..... 3-47
 - Theft-deterrent system 3-49
- Specifications 9-4
- Speedometer..... 4-12
- Starting the Engine..... 4-5
- Steering Wheel..... 3-27
 - Horn..... 4-56

Storage Compartments.....	5-138
Back trim storage box	5-139
Console box.....	5-138
Seat side box	5-138
Sunvisors.....	5-132

T

Tachometer.....	4-13
Theft-Deterrent System.....	3-49
Tiedown	
Hook.....	7-31
Tire Inflation Pressure Warning Beep...	7-51
Tire Information.....	8-24
Tire Pressure Monitoring System	4-105
Tires	6-41
Flat tire	7-3
Replacing a tire	6-43
Replacing a wheel	6-43
Snow tires.....	3-54
Specifications	9-8
Tire chains.....	3-54
Tire inflation pressure.....	6-41
Tire rotation.....	6-42
Uniform tire quality grading system (UTQGS).....	8-22
Towing	
Recreational towing	3-57
Trailer towing.....	3-57
Towing Description.....	7-30
Traction Control System (TCS).....	4-66
TCS/DSC indicator light.....	4-66
Transmitter	3-4
Trip Computer.....	4-16
Trip Meter	4-12, 4-20

Trouble

Battery runs out.....	7-23
Emergency starting.....	7-26
Emergency towing	7-30
Flat tire	7-3
Overheating	7-27
Parking in an emergency	7-2
When fuel-filler lid cannot be opened	7-29
When the roof cannot be closed....	7-57
When trunk lid cannot be opened...	7-52
Trunk Lid	3-18
Inside trunk release lever	3-20
When trunk lid cannot be opened...	7-52
Turn Signals	4-50

V

Vanity Mirrors.....	5-132
Vehicle Information Labels.....	9-2

Index

W

- Warning Lights..... 4-26
- Warning Sound is Activated..... 7-48
 - Air bag/seat belt pretensioner system warning beep 7-48
 - Blind Spot Monitoring (BSM) System warning beep 7-51
 - Ignition not switched off (STOP) warning beep 7-49
 - Key left-in-trunk warning beep (With the advanced keyless function) 7-50
 - Key left-in-vehicle warning beep (With the advanced keyless function) 7-50
 - Key removed from vehicle warning beep 7-50
 - Lane Departure Warning sound..... 7-51
 - Lights-on reminder..... 7-48
 - Power steering warning buzzer 7-50
 - Request switch inoperable warning beep (With the advanced keyless function)..... 7-50
 - Retractable fastback warning beep... 7-49
 - Seat belt warning beep 7-49
 - Tire inflation pressure warning beep 7-51
- Warranty 8-15
- Weights..... 9-6
- Windblocker..... 5-140
- Windows
 - Power windows 3-31
- Windshield Washer 4-54
- Windshield Wipers..... 4-52
- Winter Driving 3-53
- Wiper
 - Replacing windshield wiper blades..... 6-33