

2016 MAZDA MX-5 MIATA



Does Driving Matter?

Does a long, winding road or an empty freeway on Christmas morning matter if the car you're in doesn't take advantage of the moment?

Does safety, technology, efficiency or even beauty matter, if a car doesn't feel right in your hands?

If you build Mazdas, driving is what matters most.

That's why everything we do has one purpose... to make driving better.

Like creating safety technology that inspires confidence.

Engine technology that makes our cars and SUVs more fuel-efficient, responsive.

And sticky in the turns.

With designs that capture motion, even when the car isn't moving.

What's better than a great driving car?

A car company that won't build anything less.

MAZDA

Driving Matters™



**WOULD THE WORLD
BE A BETTER PLACE IF EVERYONE
DROVE A ROADSTER?**

WAS CHANGING EVERY BOLT, EVERY WIRE AND EVERY STITCH OVERKILL? WE THINK NOT.

We built this MX-5 Miata like we built the very first one. We preserved our roots, but evolved the technology. We built a roadster with beautiful proportions, heart-pounding excitement, a rocking power-to-weight ratio and a connection to the road unlike any other. The Mazda MX-5 Miata is built this way because driving matters. It matters to you. And it matters to Mazda.

The MX-5 Miata commits to the asphalt with swift agility and nimble smoothness, without hesitation. Without excessive weight. It's how we've always done it. It's how it makes you feel when you grip the steering wheel and take a curvy off-ramp after a long day. We built the MX-5 Miata to behave precisely how you, the driver, would want it to. Intuitive. Responsive. And how it just simply makes you grin from ear to ear. The value of driving dynamics is something you measure with your senses.

We built the MX-5 Miata for the s-curves. The corners. The cliff side highway corkscrews. Taking them confidently and never holding back. The MX-5 is an athletic 2,332 lbs.¹ Light. Lean. Lively. And loaded with as much thrill as you want to give it. We built the Mazda MX-5 Miata because driving matters.

¹Manual Transmission only.





< KODO: "Soul of Motion." Energy in motion. Power in motion. It's the inspiration behind the design of every Mazda vehicle. Created to transform ordinary sheet metal into something that embodies the vitality of a living being, KODO exudes the power and elegance of a wild animal in the instant before it pounces on its prey.

魂動

KODO : SOUL OF MOTION



Mazda MX-5 Miata Grand Touring shown in Soul Red Metallic

EXHILARATING. WITHOUT MOVING AN INCH.

The KODO: "Soul of Motion" design language is not just a curve in the side panels or the shape of a headlamp. You'll find it captured in every essence of the MX-5. Whether the top is up or folded neatly away, the new muscular stance conveys an aggressive design while maintaining a fluid symmetry.

Beyond its exterior, the KODO motif resonates within the doors of the MX-5 Miata. How you feel when the interior merges with

the outside landscape and you become one with the vehicle is what driving is all about. From the structure, stitching and fabric created for the seats, to the winged shape of the instrument panel and every surrounding surface before you, the environment conveys this is no ordinary experience. Because having a presence on the road and being connected to everything around you at all times matters.



HEADLIGHT

Seeing what's ahead and giving you a better view of the road matters. Because we crafted one of the world's shortest and lowest noses on a sports car, fitting the headlamps into this extremely short overhang meant reinventing the headlight. The position of each LED bulb, the parabolic-type LED high beam and the turn signal layout produce better visibility and more intensity, and yet weigh 15% less than previous models. We can't see accepting anything less than crisp, radiant light distribution.

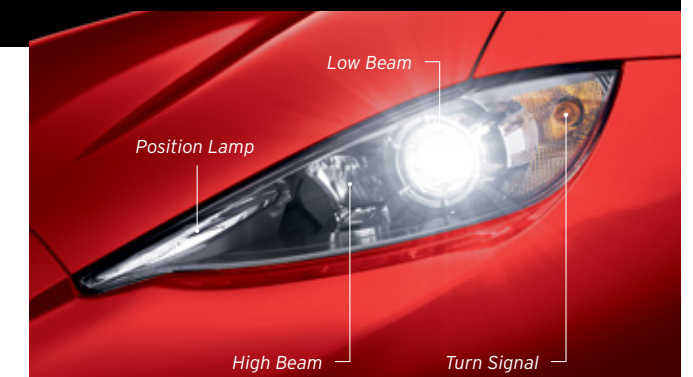

IS THE SHORTEST DISTANCE BETWEEN TWO POINTS REALLY THE BEST ROUTE?

What is it about the MX-5 Miata that makes you want to drive just a little bit longer? After evolving for 26 years, you learn a few things about what matters. Take it from longtime MX-5 Chief Program Manager, Nobuhiro Yamamoto. Not only was he on the high-profile Mazda R&D team for the 1991 Le Mans win, he leads the team today in its obsessive need to achieve absolute performance and sheer driving excitement. Of his winning strategy, Yamamoto explains, "That means a light, compact body, front midship engine and rear-wheel drive, 50:50 weight distribution, low yaw moment of inertia, and low center of gravity." Winning races, and the hearts of fans the world over, appears to keep working.

Meticulous adjustments, such as lowering the engine for a lower center of gravity and pushing the engine back, are all nuances that keep us continually developing the MX-5 so it enhances balance and directional control, and stays firmly anchored to the pavement.

And because we race everything we build, you can be assured there's a track-tuned suspension that delivers superb handling and directional stability by combining a sophisticated double-wishbone layout up front with an advanced multilink setup in the rear.

The Dynamic Stability Control¹ with an integrated Traction Control System optimizes both traction and handling in less-than-ideal road conditions without interfering with your oneness with the road. For all those twists and turns the road has in store, each and every MX-5 is precisely engineered to create balance.



¹Dynamic Stability Control (DSC) is an electronic system designed to help the driver maintain control under adverse conditions. It is not a substitute for safe driving practices. Factors including speed, road conditions and driver steering input can all affect whether DSC will be effective in preventing loss of control. Please see your owner's manual for further details.

LOSE OVER 148 LBS. AND YOU'LL WANT TO SHOW IT OFF, TOO.

Even after 26 years, the engineers at Mazda remain passionate about the MX-5 Miata's near-perfect 50:50 front-to-rear weight distribution. The quality-obsessed engineers who imagined and built the latest MX-5 Miata held fast to one simple philosophy: Preserve and innovate the front-midship engine and rear-wheel drive layout. Sustaining the deep-rooted belief that the MX-5 is not perfectly balanced until you, the driver, are literally sitting in the driver's seat.

New materials like aluminum and ultra-high tensile steel have replaced heavier components to help the MX-5 achieve lighter, yet more stable and rigid driving dynamics. The MX-5 is nearly a half-inch lower in height and has undergone a weight loss of more than 148 lbs. while maintaining a low yaw inertia and low center of gravity that commands control you'll only find in the MX-5.

Wherever possible, the MX-5 Miata underwent painstaking weight loss in all the right places. Even the window glass is lighter. The front overhang is 45mm shorter. The rear overhang is 40mm shorter. The wheelbase is 20mm shorter. The engine is mounted 12.5mm lower. You may not see it, but you'll feel it, as the MX-5's lightness contributes to its responsiveness in every corner, twist and turn. Yet through all these reductions, the engineers managed to increase the cabin interior. We do this meticulous task because this is not just another roadster. This is the MX-5.

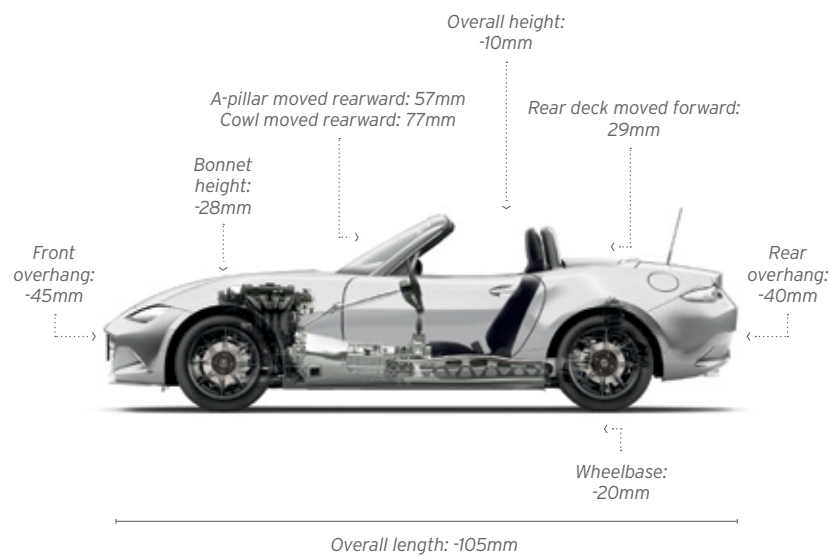

50 / 50

NEAR-PERFECT BALANCE? NOT UNTIL YOU GET BEHIND THE WHEEL.

IS IT POSSIBLE TO IMPROVE THE BEST-SELLING ROADSTER OF ALL TIME?

The respected and fundamental driving dynamics of the Mazda MX-5 Miata are fueled by the need to build a sports car that's lightweight, strong and a total blast to drive. All simply because driving matters. It's in our DNA to build cars that are responsive and faithful, which is why it's no wonder the MX-5 inspired the holistic approach to building our vehicles, called SKYACTIV® TECHNOLOGY.

SKYACTIV TECHNOLOGY makes for a lighter, stiffer and safer vehicle. And it is at the heart of the MX-5 Miata. Or is it the other way around? It's the foundation for a strong, lightweight platform with powerful-yet-efficient drivetrain that maximizes driving enjoyment with every drop of fuel. While you may not think about these aspects when you're tearing it up on a canyon curve, it matters to us that you get the most out of your sports car.



SKYACTIV ENGINE

To maintain performance in the 4th-generation MX-5 Miata, exhaustive efforts were made to reduce weight, yet preserve the responsive feel found in the very first MX-5. We started with a 22% drop in weight from the previous generation, including what could be the world's thinnest (1.7mm) cylinder head cover. The new MX-5 Miata gets the most out of its new dedicated engine with a 13.0:1 compression ratio and 4-2-1 race-inspired headers. This energizing 2.0-liter 16-valve DOHC engine delivers an assertive 155 hp and 6,000 rpm redline without sacrificing fuel efficiency, offering up to an EPA-estimated 36 highway MPG.¹ The numbers may change, but the experience remains.



SKYACTIV-MT

The distinctive *jinba ittai* experience is fully realized behind the wheel, in the MX-5 Miata's precise and ultra-responsive short-throw, close-ratio 6-speed manual gearbox. With a mere flick of your wrist, shifting from gear to gear is not only rapid and precise, but a total blast. Smaller, lighter and smoother than any we've ever built before, even the compact design of the knob has an overall weight of 300 grams. Working harmoniously, the shifter, accelerator and clutch orchestrate a tempo with the driver that is unparalleled.



A COMPLETE BODY OF WORK

How can moving the A-pillars 57mm closer to the seats, and expanding the spread angle 0.3° on the driver's side and 2.0° on the passenger's side, help you corner better? This purposeful body design isn't strictly for aesthetics. It's the minutiae that MX-5 engineers get obsessive about because it matters in g-forces. And when entering turns, having a precise grasp of your exact position should never be guesswork. So we expanded the field of vision to 5.3° and gave the front fenders high-rising edges and a lower hood to allow for accurate tire placement, so you aim the MX-5 and it responds in accord.

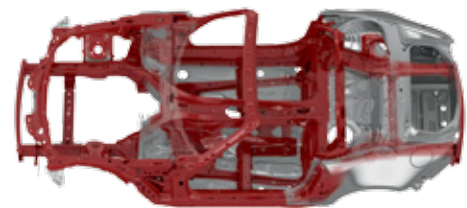

SKYACTIV-BODY

For the iconic MX-5 Miata, the challenge was to attain a lightweight, open-top sports car that felt responsive at every turn, yet minimized vibration. We crafted a sturdier structural design that used ultra-high tensile and high tensile steel in critical areas, while high-strength 7000-series aluminum materials replaced heavier steel at the front and rear bumper support, front fenders, brace bar, bulkhead and diagonal braces. The aluminum roof materials even help lower the center of gravity. The new MX-5's body is 15% lighter than that of the previous model, yet stiffer, stronger and safer.

1

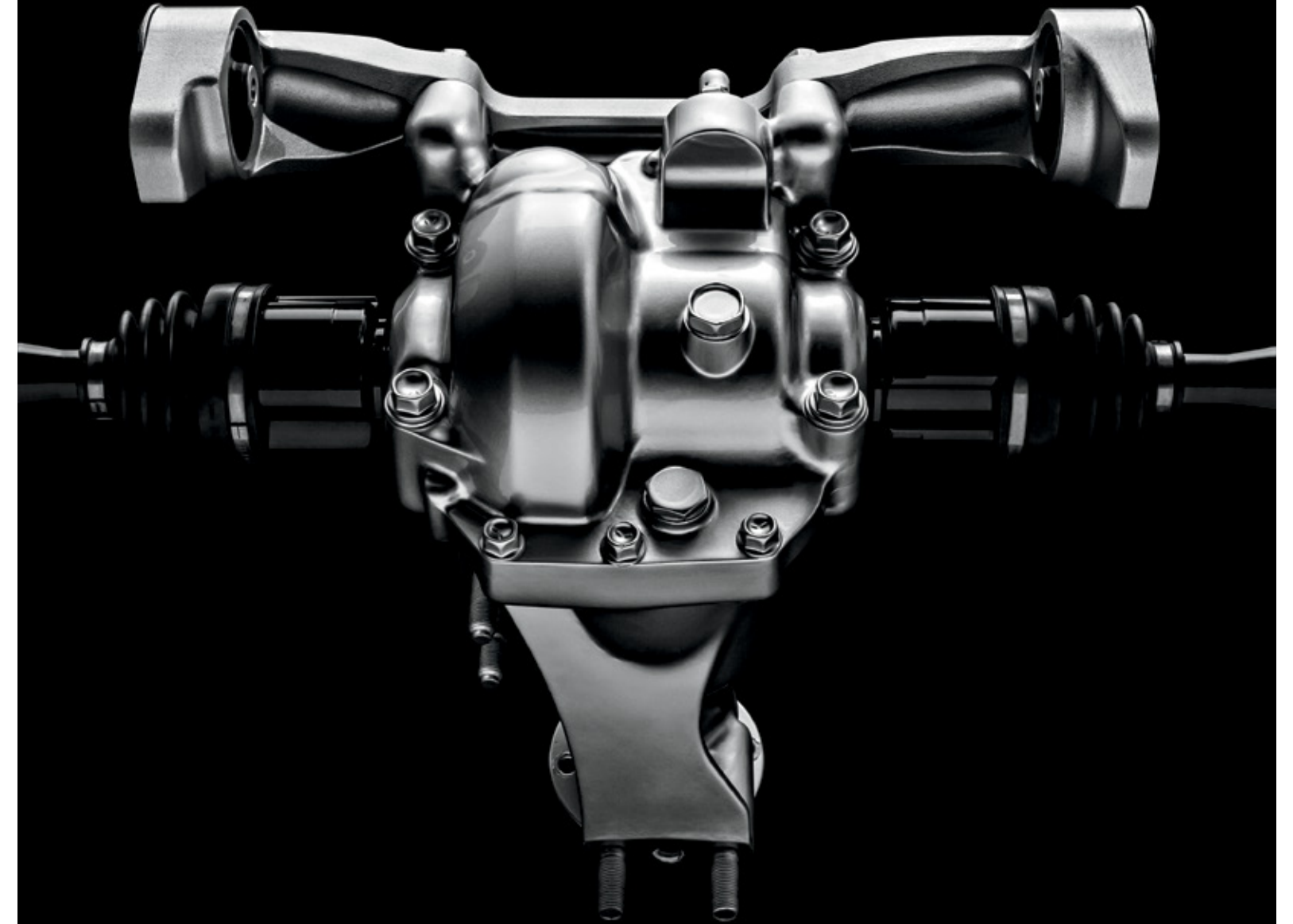

UP TO AN EPA-ESTIMATED
36 HWY
 MPG*

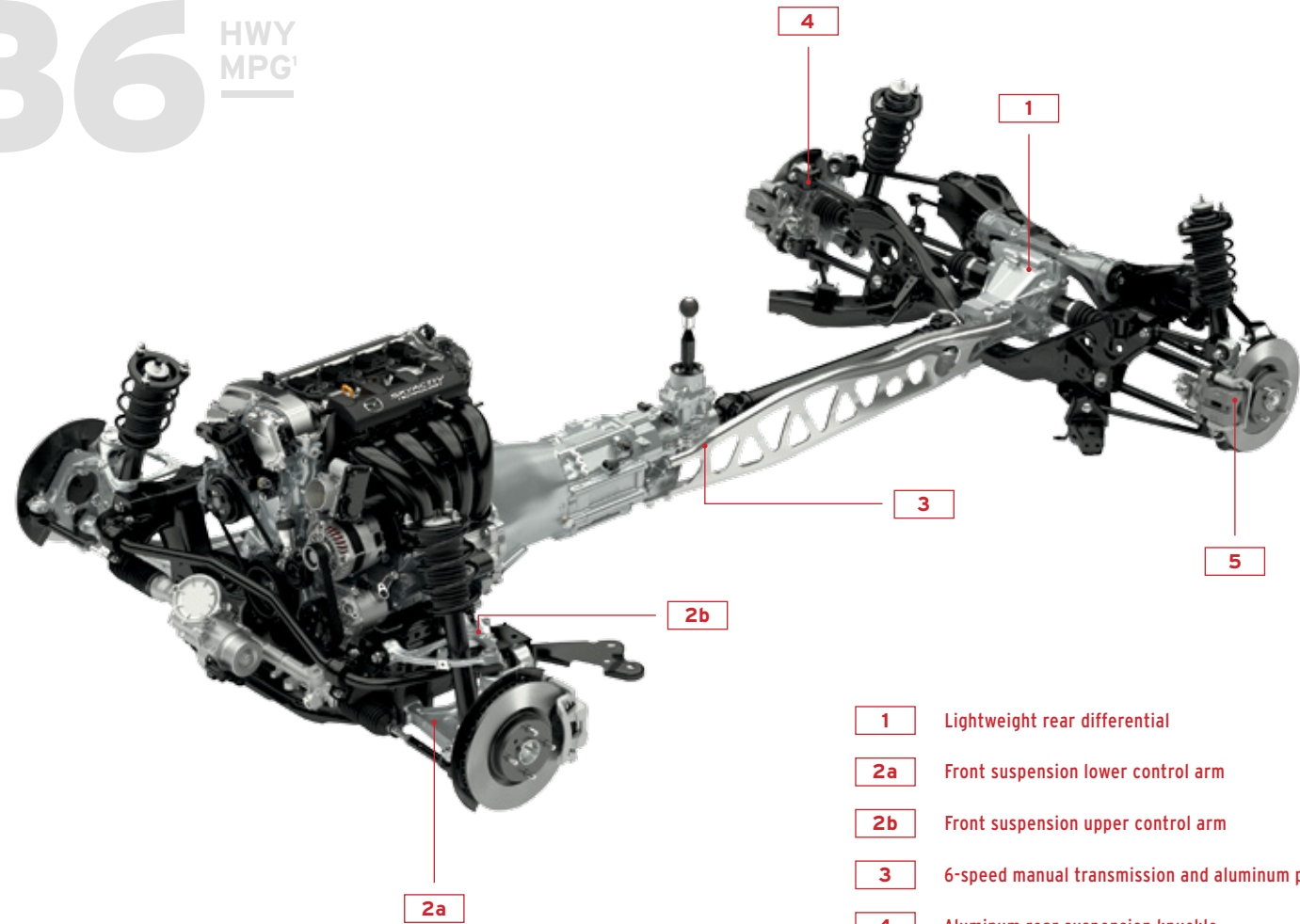

- 1** Lightweight rear differential
- 2a** Front suspension lower control arm
- 2b** Front suspension upper control arm
- 3** 6-speed manual transmission and aluminum power plant frame
- 4** Aluminum rear suspension knuckle
- 5** Rear multilink suspension

SKYACTIV-CHASSIS

Can changing the front caster angle by 1° make any difference? It does, so we did it. Getting the details just right is a Mazda engineer's sole purpose. And for the MX-5, that includes the details in the design marvel that is the highly rigid and lightweight double wishbone front suspension and multilink rear suspension. Adopting aluminum for the upper arms, lower arms and knuckles, and 780MPa-grade high-tensile steel for the crossmember, also contributed to the overall 148-lb. weight reduction.

Engineered to work in perfect harmony, the steering and suspension systems achieve two seemingly contradictory goals at once: to be nimble at low speeds, yet stable at high speeds optimizing performance in those corners. And we kept refining millimeter-by-millimeter, and ounce-by-ounce, until optimum vehicle posture and vibration-dampening performance were achieved.

POWER PLANT FRAME

This structural "backbone" helps eliminate drivetrain twist, which wastes power and produces acceleration lag. The MX-5 Miata's ingenious aluminum Power Plant Frame that unites its engine, transmission and rear differential has also undergone a weight loss of nearly 20% from its predecessor. But just eliminating the weight wasn't the only solution to increasing the rigidity and stability. Reshaping the cross-section of the frame had to be done to achieve this unparalleled driving experience. You'll feel the responsiveness and feedback—from your right foot to your fingers wrapped around the steering wheel, up to the hairs on the back of your neck.

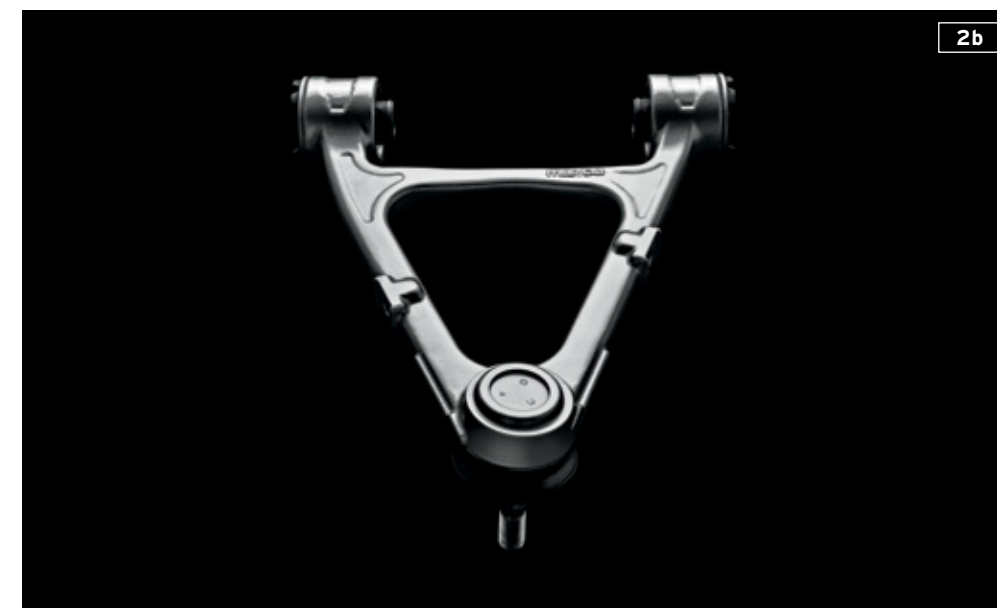

*Based on EPA estimates for 2016 Mazda MX-5 Miata models with automatic transmission 27 city/36 highway MPG. Actual results will vary.



BREMBO BRAKES



THE MAZDA MX-5 MIATA CLUB.

Enter the Mazda MX-5 Miata Club. Extraordinarily ready for the track or the streets. Things get more aggressive and athletic with a more sport-tuned suspension and Bilstein® shock absorbers and a torque-sensing limited-slip differential.¹ Delivering impeccable handling and near-telepathic control matters when carving up a curvy deserted highway. It is essential. And we won't build anything less.

Sure, the seductive appearance of the black-painted front air dam, side sill extensions and rear lip spoiler complete the aerodynamic

look, but the available Brembo/BBS Package on the Club model¹ not only turns heads, but turns corners with relentless agility. Lightweight, forged BBS 17" Gunmetal Alloy wheels give you even more confidence and control in concert with the Brembo high performance, fade-resistant ventilated front disc brakes. Because performance matters, especially when stopping.

Mazda MX-5 Miata Club shown in Ceramic Metallic with available Brembo/BBS Package

¹Manual Transmission only.



OBJECTS IN MIRROR HAVE BEEN TRYING TO CATCH UP FOR MORE THAN TWO DECADES.

The fact that the MX-5 Miata has been racing for its entire 26-year history relates directly to another amazing fact: On any given weekend, more Mazdas and Mazda-powered cars are road-raced in the U.S. than any other car.¹ And in terms of pro racing, 2015 marks the tenth season of the SCCA Mazda MX-5 Cup. Now a 12-race series, the MX-5 Cup attracts many of pro racing's top up-and-comers. It's a true test of talent and technique

in which drivers compete in identically prepped MX-5s on many of America's legendary racecourses, including Mazda Raceway Laguna Seca.

Bottom line: The best street cars make the best race cars. And the MX-5 has been—and still is—the most road-raced¹ of them all.



YOU DON'T BECOME THE WORLD'S BEST-SELLING ROADSTER BY SETTLING FOR THE STATUS QUO.

In 1989, Mazda debuted the MX-5 Miata. A quarter of a century, and more than 940,000 worldwide owners later, the MX-5 continues to define—and redefine—what a roadster is meant to be. Unwavering, uncompromising and committed to true sports car authenticity, the MX-5 has always been—and will always be—the track-proven real deal.

Nimble and near perfectly balanced, the MX-5 is an automotive icon and an engineering marvel that's built to dominate the open road, master every curve and effortlessly transform instinct into action. But to truly understand why it's the best-selling roadster of all time, you need to be in the driver's seat.

¹Based on Sports Car Club of America racing data.

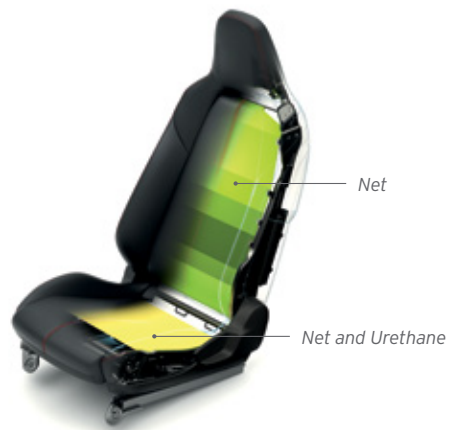

SEATS

Heated leather-trimmed bucket seats with three comfort settings in Grand Touring models are meticulously designed to conform to your every curve and adjust to your specific driving position.

To reduce vibration and improve holding capabilities of the driver, even in corners, the MX-5 seatbacks and cushions have been structurally reimagined with lighter netting materials. The best seat in the house just got more comfortable.



Mazda MX-5 Miata Grand Touring interior shown in Sport Tan leather

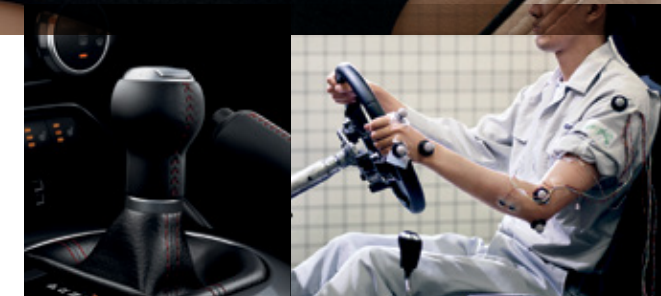

A CAR SHOULD BE AN EXTENSION OF YOUR BODY. DRIVING SHOULD BE AN EXTENSION OF YOUR SOUL.

The concept of *jinba ittai*, or “rider and horse as one,” is the inspiration for the MX-5. That a horse and its rider communicate by being instinctively in tune with each other—achieving effortless communication. The MX-5 is a car so precisely tuned, it isn't complete until one variable enters—you, the driver.

To complete that same communication behind the wheel of an MX-5, Mazda engineers used multiple electromyograms and G sensors to analyze a driver's complete interaction with the vehicle. From determining the exact location of the shift lever, to which muscles and precisely how much effort would be needed to shift, every aspect

of the drive is engineered to not just connect you with your MX-5, but make you one with it.

Is it possible to increase the cabin room without expanding the dimensions outside? Mazda engineers achieved this marvel by tilting the steering wheel 10mm, increasing the head clearance by 11mm and allowing for the seats to recline by an additional 2°. The MX-5's interior environment is designed to the utmost of form and function because it's this attention to detail that matters when someone six feet tall takes a seat behind the wheel.

WHO SAYS A TWO-SEATER SPORTS CAR CAN'T FIT EVERYTHING?

The MX-5 comes fully equipped with a wide array of amenities you wouldn't expect to find in a track-proven sports car. We've introduced our most advanced infotainment technology, MAZDA CONNECT™, into the Club and Grand Touring models.¹ All easily accessible from the multifunction Commander control within minimal distance to keep you focused on driving.

The 7-inch full color touch screen display is your window to the world and helps avoid distractions from the road. Pairing your mobile device via Bluetooth® technology connects your MX-5 to streaming media, music and social content from Facebook and Twitter feeds. Let the factory-integrated Navigation System on Grand Touring models keep you on course with voice-guided commands and advanced lane guidance. Even beyond just making and receiving hands-free calls from steering wheel-mounted controls, the SMS Text Message Audio Delivery and Reply lets you stay connected and focused.

AVAILABLE AMENITIES

Navigation System with 3D interactive map / Advanced Keyless Entry System / Automatic Climate Control



Mazda MX-5 Miata Grand Touring interior shown in black leather

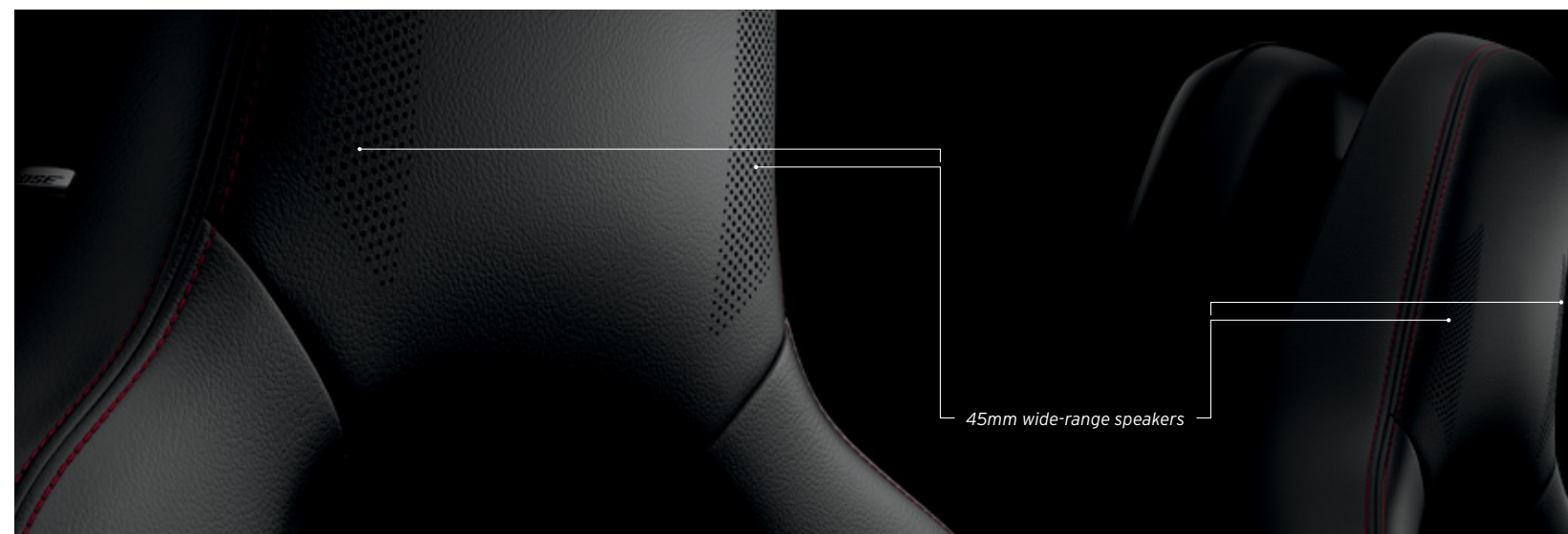

45mm wide-range speakers

YOUR OWN PRIVATE AMPHITHEATER.

The top is dropped. The sun is glistening. Your cares may be going out the top, but your tunes shouldn't go along with them. In Club and Grand Touring models, the Bose® Surround Sound system keeps the sound within the cabin—in fact, within inches of your ears. With 9 speakers, including two 45mm wide-range speakers positioned in each of the MX-5's headrests, sound is as clear as day. From bass to treble, audiophiles can enjoy pure sound quality from their MP3s through dual USB audio inputs jacks. Only the roar of the MX-5's engine will penetrate the cabin thanks to the Bose® AudioPilot® 2 noise compensation technology. Now road noise is left where it belongs—outside.



Available SiriusXM Satellite Radio² / HD Radio™ / AM/FM/CD/MP3-compatible audio system / 2 USB Audio Inputs / Pandora® / Aha™ / Stitcher™



Bluetooth is a registered trademark of Bluetooth SIG, Inc.

¹Don't drive while distracted. Even with voice commands, only use MAZDA CONNECT™/ other devices when safe. Some features may be locked out while the vehicle is in gear. Not all features are compatible with all phones. Message and data rates may apply.

²SiriusXM Satellite Radio reception requires a subscription and Mazda satellite radio. See full disclaimer in Specifications.



RETRACTABLE ROOF

In a matter of seconds, the MX-5's iconic soft top can be unlocked and dropped for pure driving enjoyment in one simple, intuitive and ergonomic step. Even positioned from the driver's seat, the release is quick, smooth and effortless—all with one hand. Should the sky suddenly decide to change, and the top require closure, we've reduced the top's weight and incorporated an "assist spring" mechanism to aid in raising the roof back into position while remaining seated. Because being comfortable in all weather matters.



**WE BUILT THE CAR. FANS BUILT THE CULTURE.
THE MIATA COMMUNITY.**

There are over 125 Mazda MX-5 clubs across the United States. Day trips, rallies, road runs, overnight excursions, track days, tech sessions, car talks and motorsports events fill our calendars. In fact, on September 5-7, 2014, over 1,900 fans attended the 25th anniversary celebration at Mazda Raceway Laguna Seca. We are the Mazda devotees who have an unrelenting passion for driving the world's best-selling roadster. Because having bugs in the grille and our tops down on 32-degree mornings is how we measure a great day. Loyal fans, enthusiasts and collectors know it's a special community to belong to because like us, driving matters. Join the club.



“Everything complements everything—the engine doesn’t overpower the chassis and brakes, and there’s ample power to produce ear-to-ear grins on twisty public roads.”

- autoweek.com, January 2015

“For pure driving bliss, look no further than the Miata—and you’ll need only one turn behind the wheel to see why.”

- CarandDriver.com, January 2015

“Every single part you touch, and facet you glimpse, looks and feels as if it’s a more mature, more sophisticated (and more expensive) car.”

- Motor Trend

“Spoiler alert: We loved it.”

- CarandDriver.com, March 2015

“Should remain one of the most rewarding convertibles you can buy.”

- Edmunds.com

MAZDA MX-5 MIATA COLORS



Soul Red Metallic*



Meteor Gray Mica



Jet Black Mica



Blue Reflex Mica



Ceramic Metallic



Arctic White



Crystal White Pearl Mica*

*Extra cost option.

MAZDA MX-5 MIATA UPHOLSTERY

SPORT

Black Cloth

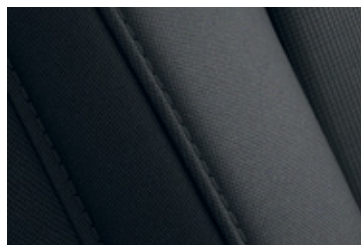

CLUB

Black Cloth with Red Accent Stitching

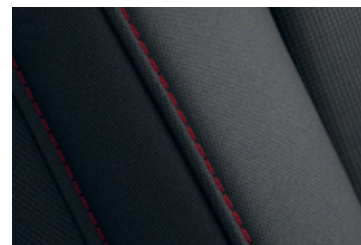

GRAND TOURING

Black Leather with Red Accent Stitching

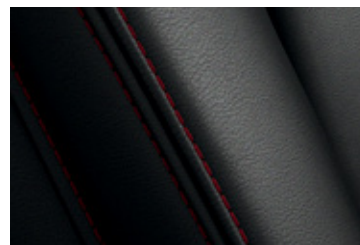

Sport Tan Leather



MAZDA MX-5 MIATA WHEELS



16-inch Alloy Sport



17-inch Alloy Club



17-inch Alloy Grand Touring

CAN A FEW BLINKING LIGHTS GIVE YOU PEACE OF MIND?

Because feeling safe and having confidence behind the wheel of a convertible sports car matters, our i-ACTIVSENSE suite of safety technologies provides the ultimate sense of security and comes standard on Grand Touring models. Knowing that there's advanced safety features active while you're enjoying the drive means less distraction. Being alerted to a hazard before it's an issue helps avoid collisions in the first place, or even lessen their impact. i-ACTIVSENSE is there when you need it, without encumbering your driving experience.

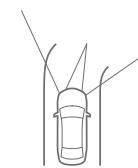
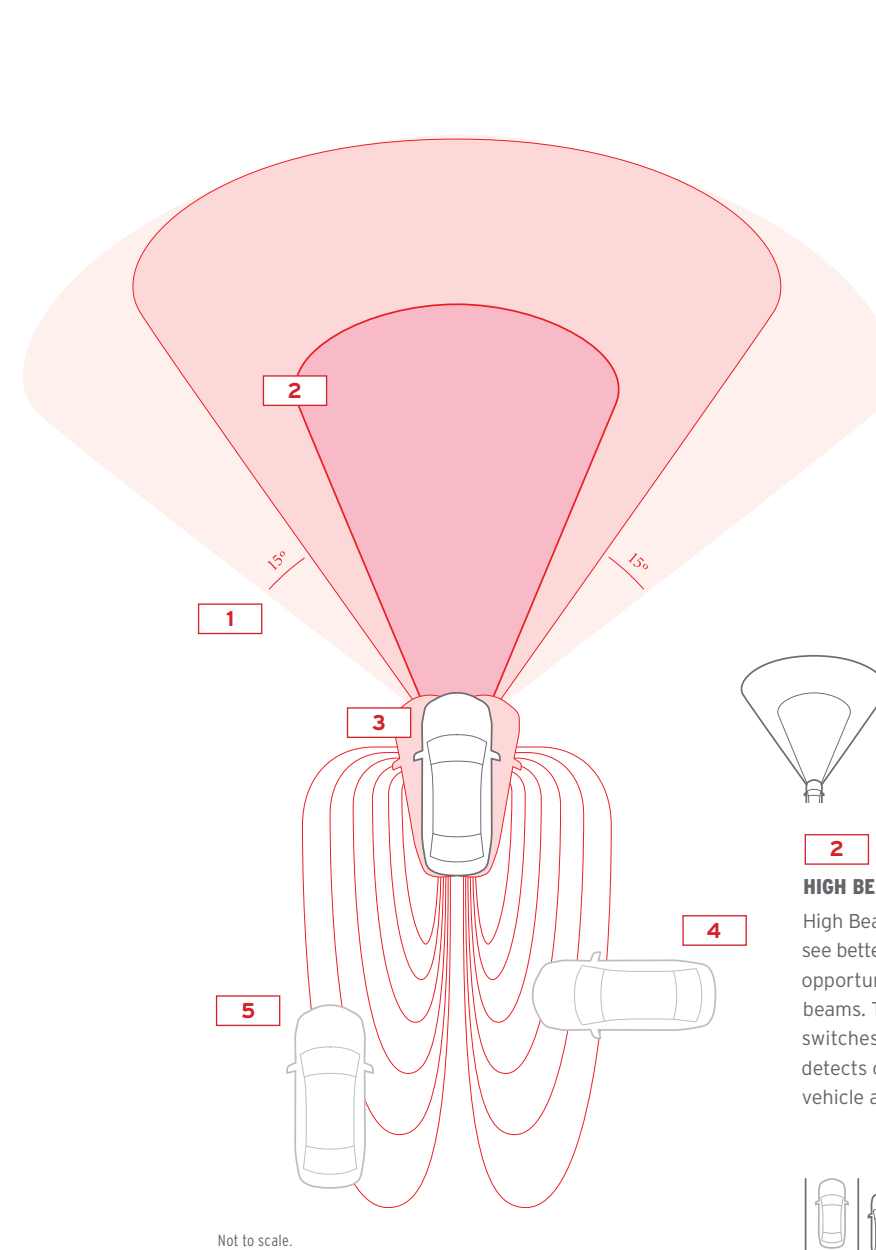

1 LED HEADLIGHTS WITH ADAPTIVE FRONT-LIGHTING SYSTEM

The MX-5 offers standard LED headlights. Grand Touring models also feature Mazda's Adaptive Front-lighting System which is designed to help you see around corners at night—literally. As you turn into a corner, the headlights pivot up to 15 degrees in the direction of your turn, improving visibility and allowing you to spot potential hazards and dangers ahead.

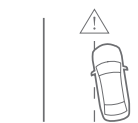

3 LANE DEPARTURE WARNING SYSTEM²

This system gives audible and visual warnings when the vehicle is about to unintentionally depart from its lane at a speed of 41 mph or higher.

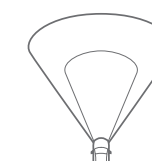

2 HIGH BEAM CONTROL

High Beam Control helps the driver see better at night by maximizing opportunities to use the high beams. The system automatically switches to the low beams when it detects oncoming traffic and/or a vehicle ahead.

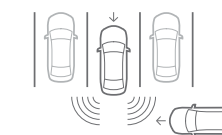

4 REAR CROSS TRAFFIC ALERT¹

When backing up, this system detects a vehicle approaching from the side and promptly alerts the driver with an audible warning, as well as a visual warning in both side mirrors.



5 BLIND SPOT MONITORING¹

Radar sensors detect objects in your left or right blind spots and then alerts you with a warning light that appears in the corresponding side mirror. If you signal a lane change while an object is there, the light blinks and a cabin warning chime sounds.

i-ACTIVSENSE

¹Always check your mirrors. Be aware of the traffic around you. ²Lane Departure Warning System is not a substitute for safe and attentive driving. There are limitations to the range and detection of the system. Please see your owner's manual for further details.

MAZDA MX-5 MIATA SPORT

16-inch aluminum alloy wheels with 195/50 R16 high performance tires
LED headlights
Daytime running lights
Black-painted power side mirrors
Black cloth convertible top with glass rear window
Air conditioning
Black cloth sport seats
Power door locks
Remote keyless entry (MT models)
Mazda advanced keyless entry system (AT models)

Power windows with driver's and passenger's one-touch-down feature
Leather-wrapped steering wheel with steering wheel-mounted audio and cruise controls
Leather-wrapped shift knob
Tilting steering column
AM/FM/CD/MP3-compatible audio system with 6 speakers including driver's headrest speakers
Bluetooth® hands-free phone and audio streaming
USB audio input port
Mesh aero board
Dual front air bags and side-impact air bags¹



WHEEL
16-inch Alloy

BLACK CLOTH



EXTERIOR COLORS

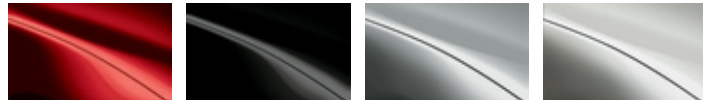

MAZDA MX-5 MIATA CLUB *Includes the following features in addition to or in place of Mazda MX-5 Miata Sport*

Exclusive 17-inch aluminum alloy wheels with Dark Gunmetal finish
205/45 R17 high performance tires
LED daytime running lights
Front shock tower brace (MT models)
Sport-tuned suspension with Bilstein® shock absorbers and limited-slip differential (MT models)
Painted black front air dam and rear lip spoiler
Black cloth seats with red stitching
Glossy black seat back bar trim

MAZDA CONNECT™ Infotainment system² with:
– 7-inch full-color touch-screen display
– Multifunction Commander control
– HD Radio
– Infotainment system voice command
– Aha™ internet radio integration
– Pandora® internet radio integration
– Stitcher™ internet radio integration
– Radio Broadcast Data System program information
– SMS text message audio delivery and reply
Dual USB audio input ports
SiriusXM Satellite Radio with 4-month trial subscription to the Sirius All Access package³

Bose® Surround Sound audio system with AudioPilot® 2
9 speakers including driver's and passenger's headrest-mounted speakers

Available Brembo/BBS Package:
includes Brembo front ventilated disc brakes with red calipers, BBS forged 17-inch alloy wheels with Gunmetal finish, Mazda advanced keyless entry system and black painted side sill extensions and rear bumper skirt (MT models)



WHEEL
17-inch Alloy with Dark Gunmetal finish

BLACK CLOTH WITH RED ACCENT STITCHING

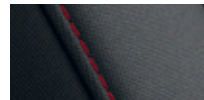

EXTERIOR COLORS



MAZDA MX-5 MIATA GRAND TOURING *Includes the following features in addition to or in place of Mazda MX-5 Miata Sport*

17-inch aluminum alloy wheels with Dark Silver finish
205/45 R17 high performance tires
Auto on/off headlights
Adaptive Front-lighting System
High Beam Control
LED Daytime running lights
Leather-trimmed sport seats
Heated seats with three settings
Glossy black seat back bar trim

MAZDA CONNECT™ Infotainment system² with:
– 7-inch full-color touch-screen display
– Multi-function Commander control
– HD Radio
– Infotainment system voice command
– Aha™ internet radio integration
– Pandora® internet radio integration
– Stitcher™ internet radio integration
– Radio Broadcast Data System program information
– SMS text message audio delivery and reply
Dual USB audio input ports
SiriusXM Satellite Radio with 4-month trial subscription to the Sirius All Access package³

Bose® Surround Sound audio system with AudioPilot® 2
9 speakers including driver's and passenger's headrest-mounted speakers

Blind Spot Monitoring⁴
Rear Cross Traffic Alert⁴
Lane Departure Warning System⁵
Auto-dimming rearview mirror with HomeLink®
Convertible top black cloth liner
Body-colored power side mirrors
Heated side mirrors
Auto-dimming driver's-side mirror
Rain-sensing windshield wipers
Automatic climate control
Navigation system
Anti-theft alarm



WHEEL
17-inch Alloy with Dark Silver finish

BLACK LEATHER WITH RED ACCENT STITCHING

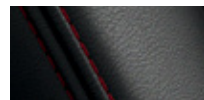

EXTERIOR COLORS



SPORT TAN LEATHER



EXTERIOR COLORS

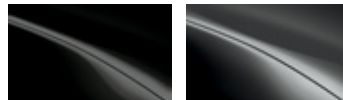

MAZDA MX-5 MIATA SPECIFICATIONS

ENGINE & TRANSMISSION

SKYACTIV-G 2.0L DOHC 16-valve 4-cylinder engine with variable valve timing
Aluminum alloy engine block and cylinder head
SKYACTIV-MT 6-speed manual overdrive transmission with short-throw shifter
6-speed Sport automatic transmission with paddle shifters

MECHANICAL

Aluminum Power Plant Frame
Rack-and-pinion steering with double pinion electric power assist
Power-assisted 4-wheel disc brakes
Anti-lock Brake System (ABS) with Electronic Brakeforce Distribution
Double-wishbone front suspension with aluminum control arms
Independent multilink rear suspension with aluminum bearing support
Front and rear stabilizer bars; gas-charged shock absorbers
Front shock tower brace (Club MT model)
Dynamic Stability Control⁶
Traction Control System

| EXTERIOR DIMENSIONS | MX-5 |
|--|--------------------|
| Wheelbase/overall length (in) | 90.9 / 154.1 |
| Overall width (in) | 68.3 |
| Overall height (in, 16" wheels/17" wheels) | 48.6 / 48.8 |
| Track, front/rear (in) | 58.9 / 59.2 |
| CURB WEIGHTS (LB) | MX-5 |
| 6-speed manual | 2,332 |
| 6-speed Sport automatic | 2,381 |
| INTERIOR DIMENSIONS | MX-5 |
| Head/leg/shoulder (in) | 37.4 / 43.1 / 52.2 |

| ENGINE | |
|------------------------------------|---|
| Engine size and type | SKYACTIV-G 2.0L 4-cylinder DOHC gasoline engine |
| Valve gear | DOHC 16-valve with variable intake-valve timing |
| Horsepower, SAE net | 155 hp @ 6,000 rpm |
| Torque, SAE net (lb-ft) | 148 lb-ft @ 4,600 rpm |
| Bore and stroke (in) | 3.29 x 3.59 |
| Compression ratio | 13.0:1 |
| Ignition system | Distributorless electronic |
| Fuel system | Electronically-controlled, direct injection |
| Recommended fuel | Premium unleaded gasoline |
| Overall steering ratio | 15.5:1 |
| Steering wheel turns, lock-to-lock | 2.7 |
| Turning circle, curb-to-curb (ft) | 30.8 |
| Brakes | 11-inch ventilated front discs; 11-inch solid rear discs |

| TRANSMISSION RATIOS | 6-SPEED MANUAL | 6-SPEED AUTOMATIC |
|---------------------|----------------|-------------------|
| 1ST GEAR | 5.087 | 3.538 |
| 2ND GEAR | 2.991 | 2.060 |
| 3RD GEAR | 2.035 | 1.404 |
| 4TH GEAR | 1.594 | 1.000 |
| 5TH GEAR | 1.286 | 0.713 |
| 6TH GEAR | 1.000 | 0.582 |
| FINAL DRIVE | 2.866 | 3.454 |

| CAPACITIES | |
|------------------------------|------|
| Cargo volume (cu ft) | 4.6 |
| Fuel capacity (U.S. gallons) | 11.9 |

| FUEL ECONOMY (EPA-ESTIMATED MPG, CITY / HWY) | |
|--|----------------------|
| SKYACTIV-MT 6-speed manual | 27 / 34 ⁷ |
| 6-speed Sport automatic | 27 / 36 ⁷ |

WE'RE COMMITTED TO OUR DRIVERS.

Every new 2016 Mazda MX-5 Miata is protected by a:

- 3-year / 36,000-mile¹ New Vehicle Limited Warranty
- 3-year / 36,000-mile² 24/7 Emergency Roadside Assistance Program
- 5-year / 60,000-mile¹ Limited Powertrain Warranty
- 5-year / unlimited-mileage Warranty Against Body Rust-Through (Anti-Perforation Limited Warranty)

¹Whichever comes first.



Even after your vehicle warranty has expired, Mazda Extended Confidence provides nearly all the same parts and components covered under your New Vehicle Limited Warranty. Accepted nationwide and utilizing only Mazda Genuine Parts (where available), Mazda Extended Confidence gives you peace of mind for miles beyond your expectations.

FINANCING WITHOUT THE FUSS.



Whether you're buying or leasing a new Mazda, Certified Pre-Owned Mazda or a used vehicle, Mazda Capital Services[®] can help make the financing process more convenient and satisfying. One of the largest auto lenders in America, Mazda Capital Services is known for first-class customer service, a wide range of financing options and highly competitive rates.

To find out which purchase or lease plan is right for you, talk with your Mazda Dealer or visit MazdaUSA.com.

⁷The tradename "Mazda Capital Services," as well as the Mazda and Mazda Capital Services logos, are owned by Mazda Motor Corporation or its affiliates and are licensed to JPMorgan Chase Bank, N.A. ("Chase"). Retail/loan and lease accounts are owned by Chase.

FOR DETAILS, PLEASE SEE YOUR MAZDA DEALER, VISIT MAZDAUSA.COM OR CALL TOLL-FREE (800) 639-1000.

SKYACTIV is a registered trademark of Mazda Motor Corporation.

Bluetooth is a registered trademark of Bluetooth SIG, Inc.

¹Always wear your seat belt and ensure that the passenger air bag deactivation light is illuminated when using a child- or infant-restraint system. Please see your owner's manual for details. ²Don't drive while distracted. Even with voice commands, only use MAZDA CONNECT™/ other devices when safe. Some features may be locked out while the vehicle is in gear. Not all features are compatible with all phones. Message and data rates may apply. ³SiriusXM Satellite Radio reception requires a subscription and Mazda satellite radio. Subscriptions to SiriusXM services are sold by SiriusXM after a 4-month trial subscription to the SiriusXM All Access package expires and are continuous until you call SiriusXM at 1-866-635-2349 to cancel. See SiriusXM Customer Agreement for complete terms at www.siriusxm.com. Sirius satellite service available only to those at least 18 and older in the 48 contiguous USA, D.C., and P.R. (with coverage limitations). Sirius, XM and all related marks and logos are trademarks of Sirius XM Radio Inc. ⁴Always check your mirrors. Be aware of the traffic around you. ⁵Lane Departure Warning System is not a substitute for safe and attentive driving. There are limitations to the range and detection of the system. Please see your owner's manual for further details. ⁶Dynamic Stability Control (DSC) is an electronic system designed to help the driver maintain control under adverse conditions. It is not a substitute for safe driving practices. Factors including speed, road conditions and driver steering input can all affect whether DSC will be effective in preventing loss of control. Please see your owner's manual for further details. ⁷Actual results will vary.



Mazda
DRIVE FOR GOOD

Last year during our Mazda Drive for Good® charitable program, our Mazda Dealers and partners raised millions of dollars for a number of national and local charities. But what's even more significant is that collectively, we pledged more than 66,000 hours of volunteer time to local and national organizations across the country. Our Mazda Dealers have a long history of giving back both time and money to their own communities. And their efforts truly define our Mazda values.

Mazda Drive for Good® is just one of the many charitable programs that has allowed Mazda to donate millions to worthy causes across the United States since 1992.

Because giving back is the Mazda Way.

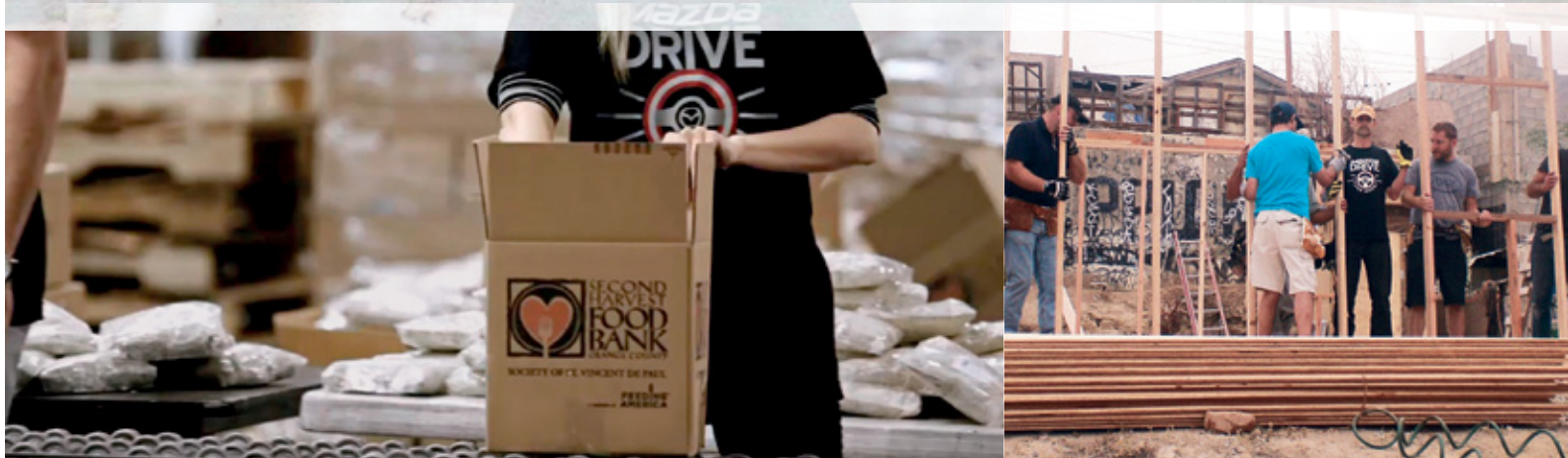

*WE KNOW YOUR FIRST
IMPRESSION OF MAZDA
STARTS WITH US,
YOUR MAZDA DEALER.*

It's a responsibility we don't take lightly.

It's why we work hard every day to make sure your customer service experience exceeds your expectations, in every way.

From the factory to your first test drive,

and to every drive you'll ever make in a Mazda,

we're here because driving matters.



MazdaUSA.com



© 2015 Mazda Motor of America, Inc. • 7755 Irvine Center Drive, Irvine, CA 92618 • (800) 639-1000 • Correct at time of printing. Printed in U.S.A. 6/15 (30K)
Part no. 9999-92-MX5-16

PRODUCT CHANGES AND OPTIONS AVAILABILITY: Following publication of this brochure, certain changes in standard equipment, options, prices and the like-or product delays-may have occurred which would not be included in these pages. Your Mazda Dealer is your best source for up-to-date information. Mazda reserves the right to change product specifications at any time without incurring obligations. Options shown or described in this brochure are available at extra cost and may be offered only in combination with other options or subject to additional ordering requirements or limitations.



DRIVING MATTERS™

ZOOM-ZOOM