

*MAZDA MX-5 MIATA*  
**SMART START GUIDE**

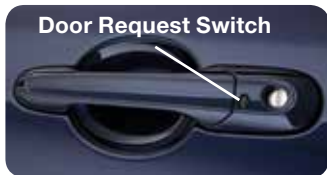

# Key



## ADVANCED KEYLESS ENTRY SYSTEM

- This system allows you to lock/unlock the doors, open the trunk lid, and even start the engine without ever taking the key out.

### While Carrying the Advanced Key...

- **Unlock the driver's door** by pushing the driver's door request switch once.
- **Unlock both doors** by pushing the driver's door request switch twice OR by pushing the passenger's door request switch once.
- **Lock both doors** by pushing the driver's door or passenger door request switch once.
- **Open the trunk** by pushing the trunk request switch once.
- **Open the front windows** by pushing the unlock button on the advanced key and then pushing again and holding; release to stop.

## KEYLESS ENTRY SYSTEM

This system remotely locks and unlocks the doors and the trunk, and opens the power windows.

### Release Button

- Push to extend key.
- Push & hold to retract key.

### Lock

- Push once to lock both doors.
- Push twice (within five seconds) for horn sound verification that both doors are locked.

### Trunk

- Push and hold to open trunk.

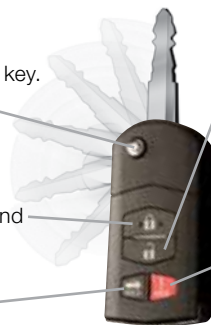

### Unlock

- Push once to unlock driver's door.
- Push twice (within three seconds) to unlock both doors.
- Push twice and hold to open front windows.

### Panic Alarm

- Push for one second or more to activate alarm.
- Push lock, unlock, or panic alarm to turn alarm off.

### Retractable Key



## STARTING THE ENGINE

### While Carrying the Advanced Key...

- **Start the engine** by pushing the start knob in and turning it (like a normal key) while pushing the clutch pedal (manual transmission) or the brake pedal (automatic transmission).
- **Shut the engine OFF** by turning the start knob to the ACC position and then pushing in and turning to the Lock position.

**NOTE:** The **KEY** indicator light will illuminate **GREEN** when the advanced key is detected. If the **KEY** indicator light flashes **GREEN**, the advanced key transmitter battery power is low.

- If the advanced key cannot be used due to a malfunction or dead advanced key battery, use the auxiliary key to lock/unlock the doors and to start the engine.

**NOTE:** **RED** Key Indicator Light may flash if the key is placed in the cup holder. The key may not be detected in the cup holder.

### With the Auxiliary Key...

- 1 To start engine, remove the start knob cover by squeezing both release buttons and pulling the cover off.
- 2 Push the key release to remove the auxiliary key.
- 3 Insert the auxiliary key into the key cylinder and turn it to start the engine.





## SEAT CONTROLS

### Height Adjustment Lever

Raise or lower seat height by repeatedly pulling up or pushing down on the lever.

### Recline Lever

Pull up to adjust seatback angle.

### Slide Release Lever

Pull lever up to move seat backward or forward.



## Seat Warmers

The driver and passenger seats can be warmed by rotating the applicable seat warmer dial while the ignition is ON.

- Seat temperature increases as the number on the dial increases.
- When the seat warmers are not needed, rotate the dials to 0.



**NOTE:** The seat heaters may not turn on if the seats are warmer than the thermostats low point (such as if the top is down and the seats are warmed by the sun on a cold sunny day or the ambient temperature is high).

## Behind Seat Storage (Soft Top Only)

Move seatbacks forward to access the seat back trim storage boxes.





## FUEL DOOR RELEASE

The fuel door release is in the seat side box located between the seats.

- 1 Pull handle to open the seat side box.
- 2 To open the fuel door, pull the fuel door release.



## FUEL DOOR

To avoid scratching the paint during refueling, secure the fuel filler cap tether over the hook as shown.

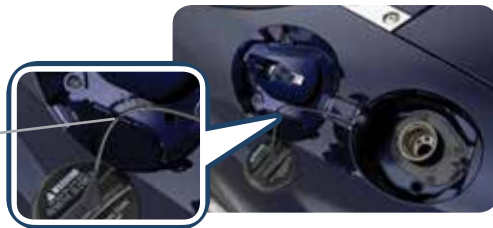

## FUEL REQUIREMENTS

91-octane fuel is recommended. If 91-octane fuel is not available, fuel as low as 87-octane can be used temporarily for emergency purposes. Use of fuel lower than 91-octane can decrease performance, cause knocking/engine noise, deteriorate shift quality, and possibly increase fuel consumption. Refueling the vehicle with correct octane fuel a couple of times will restore vehicle performance and shift quality.

# Driver's View

**LIGHTING/  
TURN SIGNALS**  
(P. 9)

**BLUETOOTH®  
HANDS-FREE/  
AUDIO CONTROL**  
(P. 25)

**CRUISE  
CONTROL**



**DYNAMIC  
STABILITY  
CONTROL (DSC)**



**TRUNK  
RELEASE**

**HOOD  
RELEASE**

**TILT STEERING  
WHEEL LEVER**

**WIPER/  
WASHER**  
(P. 10)

**AUDIO**  
(PP. 23-24)

**HAZARD  
WARNING**

**PASSENGER  
AIRBAG OFF  
INDICATOR<sup>1</sup>**



**POWER  
RETRACTABLE  
HARDTOP  
(If equipped)**  
(P. 18)

**CLIMATE  
CONTROL**  
(PP. 21-22)

**ACCESSORY  
SOCKET**

**AUX JACK**  
(P. 12)

**SEAT  
WARMERS**  
(P. 3)



<sup>1</sup> This indicator light illuminates to remind you that the front passenger's front/side airbags and seat belt pretensioner will not deploy during a collision. The reason for this is that the weight in the seat is less than approximately 66 lb. Always wear your seat belt and if a front facing child seat must be used, you must deactivate the passenger airbag. See the Owner's Manual for important information on this safety feature.

# Instrument Cluster



DASHBOARD  
ILLUMINATION\*

FUEL GAUGE

TACHOMETER

ENGINE OIL  
PRESSURE GAUGE

## GLOSSARY OF WARNING AND INDICATOR LIGHTS

**NOTE:** See Owner's Manual for more details and explanations.

 **Low Fuel Level**

 **Dynamic Stability Control (DSC)/Traction Control System (TCS) Off Indicator Light**

DSC OFF switch pushed and TCS/DSC turned off.

 **ABS (Antilock Brake System) Malfunction**

 **Check Engine Light**

 **Charging System Malfunction**

 **Traction Control System (TCS)/Dynamic Stability Control (DSC)**

On: TCS/DSC malfunction  
Flashing: TCS/DSC operating

 **Malfunction Warning Light**

 **Shift Lever Position Indicator**

**AT** **Automatic Transmission Malfunction**

 **Turn Signals/Hazard Warning Indicator Lights**

 **Key Warning RED** (p. 2)  
Advanced key not detected or advanced key battery is dead.

 **Key Detected (engine ready to start) GREEN** (p. 2)  
On: Advanced key detected; engine is ready to start.  
Flashing: Advanced key battery is low.

 **Air Bag/Front Seat Belt Pretensioner System Malfunction**

 **Headlight High Beams On** (p. 9)

 **Seat Belt Unbuckled/Malfunction**

 **Security Indicator Light**





**AMBIENT  
TEMPERATURE**

**ODOMETER/  
TRIP METER**

**SPEEDOMETER**

**ENGINE COOLANT  
TEMPERATURE  
GAUGE**

**INFO  
BUTTON**



**Door Ajar**



**Brake Warning Light**

Parking brake on/low brake fluid/malfunction

**CRUISE**

**Cruise Main Indicator  
Light On (AMBER)/  
Cruise Set Indicator  
Light On (GREEN)**



**Tire Pressure  
Monitoring System  
(TPMS) Warning Light\***

On/Warning Bleep: Low tire pressure in one or more tires.

**FLAT  
TIRE**

**Flat Tire**  
Flat tire/malfunction

## INFO

Push INFO button to display the following below the odometer:

- Trip Meter A
- Trip Meter B
- Average fuel economy
- Ambient Temperature Display

## NOTE:

- To clear trip and average fuel economy, push and hold INFO button when displayed.
- To change the ambient temperature display between °F and °C, push and hold INFO button when displayed.

**\*TPMS NOTE:** Low ambient temperature and/or high altitude causes tire pressures to drop and may turn the TPMS warning light on. If the warning light comes on, check the tire pressure and fill the tires as soon as possible, preferably before moving the vehicle and warming up the tires. Tire pressure should be checked when the tires are cold.

<sup>1</sup> When exterior lights are on, rotate the knob to adjust the brightness of the instrument cluster and other dashboard illuminations.

## LIGHTING CONTROL/TURN SIGNAL LEVER

: Turns tail, parking, dashboard, and headlights on.

: Turns fog lights on only when headlights are on.

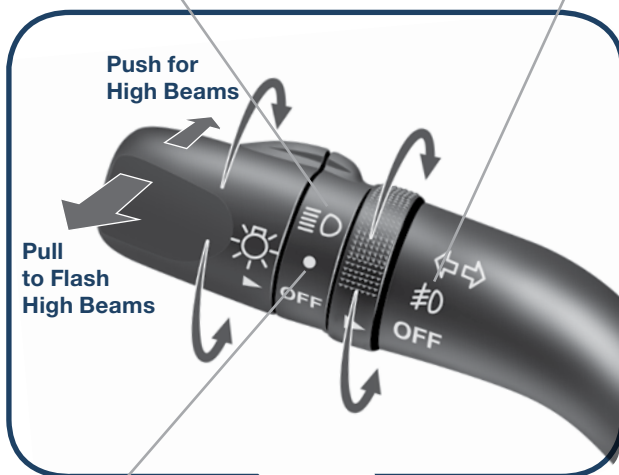

: Turns tail, parking, and dashboard lights on.



## WINDSHIELD WIPER/WASHER CONTROL LEVER

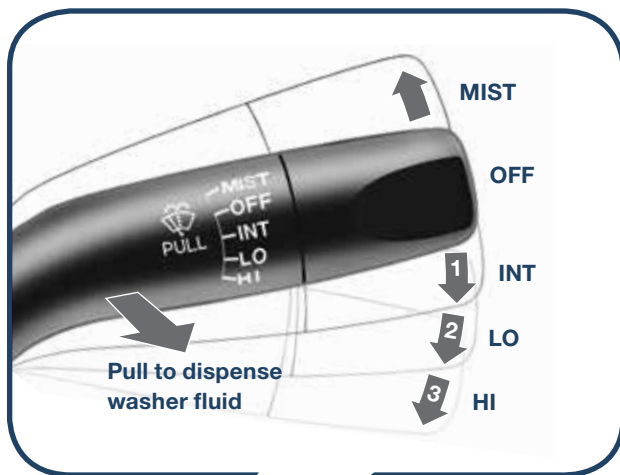

# Transmission

## AUTOMATIC TRANSMISSION (if equipped)

### Sport A/T Manual Shift Mode

*The Sport A/T Manual Shift Mode gives you the feel of driving a manual transmission by allowing you to manually shift to control engine rpm and torque when more control is desired.*

#### To Use Manual Shift Mode:

- Shift lever from D to M.

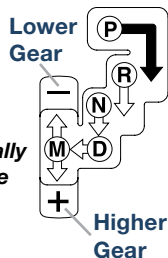

#### NOTE:

- Changing to manual mode can be done while driving the vehicle.
- The transmission will not upshift automatically in manual mode, even if the tachometer reaches redline.

#### To Shift Down To A Lower Gear:

- Tap shift lever forward (-) once.  
**OR**
- Push the DOWN steering shift switch.



#### To Shift Up To A Higher Gear:

- Tap shift lever back (+) once.  
**OR**
- Pull the UP steering shift switch.

The transmission will automatically adjust how and when it shifts gears based on road conditions and your driving style. The transmission may stay in a lower gear longer than usual when going up or down hills or driving around corners. This feature gives you better control and a more connected driving experience.

### Direct Mode

To manually shift gears while in Drive, the steering shift switches may be used. After manually shifting, the transmission will return to normal drive mode under any of the following conditions:

- 4 seconds of steady throttle
- Accelerator pedal is fully depressed (Wide Open Throttle)
- Tachometer reaches redline
- Vehicle is stopped or moving at a slow speed



## 6-SPEED MANUAL TRANSMISSION

- Push the clutch pedal completely down to start the engine and to shift gears.
- To place the transmission in Reverse, place shifter in the neutral position, push the shifter down, move to the left and push forward.

## PORTABLE AUDIO PLAYER INTEGRATION USING THE AUX JACK

Your vehicle is equipped with an AUX or auxiliary jack that will allow you to play your portable audio player through the vehicle's audio system. Learn the system when parked and do not let it distract you while driving.

**NOTE:** You will need an audio cable with an 1/8 inch (3.5 mm) mini stereo plug (available as a Genuine Mazda accessory) to connect your portable audio player into the aux jack.

Refer to the Owner's Manual for additional information.

- 1 Locate the AUX jack below the climate controls.
- 2 Plug 1/8 inch mini stereo plug into the portable audio player and into the AUX jack. Turn portable audio player on.
- 3 Turn the vehicle audio system on.
- 4 Push the AUX button on the audio face or the MODE button on the steering wheel controls.
- 5 Use the portable audio player controls to play music.



**IMPORTANT:** Set the volume level on your portable audio player to the highest level before distortion starts, then adjust the volume on the audio system.

## AUTO-DIMMING MIRROR AND HOMELINK®



### Auto-Dimming Mirror On Off

- Auto-Dimming will automatically darken your rearview mirror to reduce headlight glare from vehicles behind you.
- Auto-Dimming is activated every time the vehicle is started.

**NOTE:** In addition to the auto-dimming mirror's rear light sensor, there is also a front light sensor (not shown). Do not place or hang any objects over the front or rear mirror light sensors, otherwise, the auto-dimming mirrors will not operate properly.

### HomeLink®

- This feature provides a convenient way to replace up to three transmitters such as garage door openers, home lighting remotes and other radio frequency devices.
- Refer to your Owner's Manual for complete programming details.

## ALUMINUM WHEEL CARE

Your aluminum wheels have a protective coating on them. Only use a mild soap or neutral detergent with a sponge or soft cloth to clean them.

**CAUTION:** Using a wire brush, polishing compound, solvent, or any type of abrasive cleaner may damage the protective coating.



## PERSONALIZE YOUR MX-5 WITH GENUINE MAZDA ACCESSORIES

Go to [www.MyMazda.com](http://www.MyMazda.com), then select "Accessories" below the MyMazda Home header for a complete listing of available accessories for your Mazda MX-5.



## INSTANT MOBILITY SYSTEM (IMS)

The IMS emergency flat tire repair kit (located in the trunk) is for a temporary repair of a slightly damaged flat tire, resulting from running over nails, or similar sharp objects on the road surface. Refer to your Owner's Manual for complete details.



# Convertible Top

## MANUAL CONVERTIBLE TOP

When raising or lowering the manual convertible top, the vehicle must be stopped on level ground with parking brake set, windows lowered a minimum of 1 inch and all items in the convertible top storage area removed.

**NOTE:** When the latch is released, the audio volume may drop to zero for one second. See the owner's manual for audio system operation differences with top up and down.

### To Lower:

- 1 Push release button **A** while pulling latch **B** rearward to disengage.

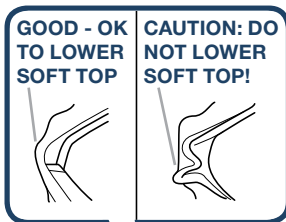

**CAUTION:** Before lowering soft top, please pay close attention to the folding points on each side of the soft top, and make sure nothing is stored in the well otherwise damage could occur.

- 2 Pull front of top rearward to release from windshield header.



- If opening from inside vehicle, use either handle.



- If opening from outside vehicle, grasp side of top, near windshield header.



- 3 Fold back top and push firmly on front of top to securely lock in open position.



**NOTE:** If manual soft top does not fold easily, then slowly lower it while pushing down on the upper part of rear glass with your hand.



- 4 Raise wind blocker.



**To Raise:**

- 1 Lower wind blocker.
- 2 Pull unlock lever to release top from open position.



# Convertible Top

3 Pull front of top forward to closed position (against the windshield header).



- If closing from inside vehicle, grasp either handle.



- If closing from outside vehicle, grasp side of top near windshield header.

4 Push lever on top latch forward until lock button clicks and top latch is securely locked.



**WARNING:** If red indicator is visible on release button, top is not securely latched.

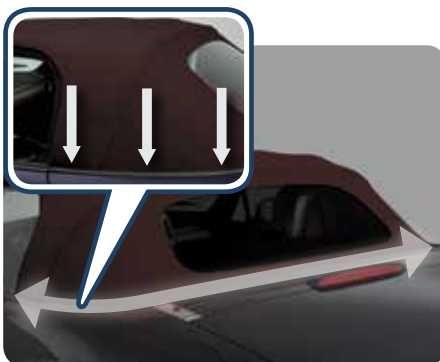

**NOTE: Manual Convertible Top Maintenance:** Remove leaves or other matter that may accumulate around the area where the soft top meets the vehicle body to prevent water drainage outlets from becoming clogged. Clogged water drainage outlets may result in water intrusion into the passenger compartment. For detailed maintenance of the water drains, refer to MyMazda.com or consult an Authorized Mazda Dealer.

## POWER RETRACTABLE HARDTOP

When raising or lowering the power retractable hardtop, the vehicle must be stopped on level ground with parking brake set and ignition on. Shift manual transmission to neutral or shift automatic transmission to Park or Neutral.

**NOTE:** When the latch is released, the audio volume may drop to zero for one second. See the owner's manual for audio system operation differences with top up and down.

### To Lower:

- 1 Push release button **A** while pulling latch **B** rearward to disengage. The indicator light will illuminate when the latch is disengaged indicating the top can be opened.



**CAUTION:** Before lowering top, make sure nothing is stored in the well otherwise damage could occur.

- 2 Push and hold the open button. The indicator light will flash during the opening operation.

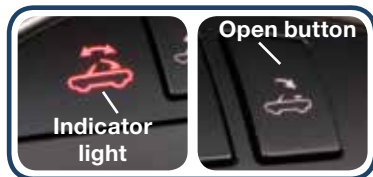

- Windows automatically lower, deck raises, top lowers, and then deck closes.

**NOTE:** A beep sounds and the indicator light turns off to confirm operation is complete.



# Convertible Top

- 3 Raise wind blocker.



## To Raise:

- 1 Lower wind blocker.



- 2 Push and hold the close button.  
The indicator light will flash during the closing operation.



- Windows automatically lower, deck raises, top raises, deck closes.

**NOTE:** A beep sounds and the indicator light turns off to confirm operation is complete, only after the hard top is locked in place.



- 3 Push lever on top latch up until lock button clicks and top latch is securely latched.



**WARNING: If red indicator is visible on release button, top is not securely latched.**



**NOTE:**

- If open/close button is released during operation, the operation will stop and a beep will sound.
- If trunk is open, a beep sounds when pushing open/close buttons and top will not operate until trunk is closed.
- If beep sounds when vehicle is placed in gear, verify the power retractable hardtop is fully lowered/raised and the latch is closed if in raised position.
- In case of a power loss, the tools for manually raising the power retractable hardtop are located in the glove compartment; see Owner's Manual for manual operating instructions.









# Manual Climate Control



## Mode Selector Dial

Rotate the dial to select airflow mode.

**NOTE:** Turn the mode selector dial to an OPEN MODE position for maximum comfort while the roof is retracted.

-  Dashboard vents (Open Mode)
-  Dashboard and floor vents (Open Mode)
-  Floor vents (Open Mode)
-  Dashboard vents
-  Floor vents
-  Defroster and floor vents
-  Defroster vents

Push  to defrost the rear window.

**NOTE:** When set to maximum cold position, the dashboard vents or dashboard and floor vents will turn the A/C on and recirculated air will be selected for maximum cooling.

## Temperature Control Dial

Rotate the dial for temperature control.



Push to recirculate cabin air to reduce outside odors and improve cooling (indicator on) or receive fresh air (indicator off).

## Fan Control Dial

Rotate the dial to set desired fan speed.

Rotate dial to OFF to turn system off.

**A/C** Push to manually turn air conditioning on or off.

## Best Cooling Settings (with top open)



## Best Heating Settings (with top closed)



# Automatic Climate Control





## Mode Selector Dial

Rotate the dial to select airflow mode.

**AUTO:** Place the Mode Selector Dial and the Fan Control Dial in the AUTO position. The airflow mode and the amount of airflow will be automatically controlled in accordance with the set temperature.

**NOTE:** Turn the mode selector dial to an OPEN MODE position for maximum comfort while the roof is open.

 Dashboard vents (Open Mode)

 Dashboard and floor vents (Open Mode)

 Floor vents (Open Mode)

 Dashboard vents

 Floor vents

 Defroster and floor vents

 Defroster vents

Push  to defrost the rear window.

## Temperature Control Dial

Rotate the dial for temperature control.

 Push to recirculate cabin air to reduce outside odors and improve cooling (indicator on) or receive fresh air (indicator off).

Automatic temperature control always works, even if the AUTO indicator light is turned off when changing the fan speed or air flow mode.

## Outer Vents

Push button to open/close outer vents only.



## Fan Control Dial

- Rotate the dial to set desired fan speed.

- Rotate dial to **A/C OFF** to turn system off. Push to manually turn air conditioning on or off.



# Audio Controls

## SETTING YOUR CLOCK

1. Push and hold the **CLOCK** button for 2 seconds until a beep is heard and the displayed time flashes.
2. Use **H** to set hours and **M** to set minutes, then push the **CLOCK** button.

**NOTE:** To select 12-hour or 24-hour clock time, turn the **TUNE/AUDIO CONT** dial while the clock display is flashing. After selecting the desired display, push the audio control dial to return to the flashing clock display.



## POWER ON

Push the Power/Volume dial to turn the audio system on.

## MEDIA SELECTION

**Radio:** Push FM/AM button to select the FM1, FM2, or AM band. The selected band will be indicated in the Radio Display.



New Mazda vehicles equipped with SiriusXM® Satellite Radio will receive an introductory subscription with a limited term trial offer to over 150 channels of SiriusXM Satellite Radio. Enjoy commercial-free music, plus sports, news, entertainment, and every premium channel in your vehicle. Call 877-447-0011 to activate. See the Owner's Manual and/or dealer for details.

**CD:** Push CD to select the CD player.

**Auxiliary Input:** Push the AUX button to select the auxiliary jack.

## TUNING

The radio has the following tuning controls:

- **Manual Tuning:** Turn the TUNE dial to manually change the frequency.
- **Seek Tuning:** Push the SEEK/TRACK <> tuning buttons to seek a higher or lower frequency with a station.
- **Scan Tuning:** Push the SCAN button to automatically sample strong stations for a few seconds each. Push again to cancel.
- **Preset Channel:** Push the Preset Channel buttons (1-6) to select a station stored in memory. To store a station, push and hold a button (1-6) until a beep is heard.







### TO LOAD/PLAY A CD

(if equipped with 6-CD changer)

1. Push the **LOAD** button.
2. After "IN" is displayed on the Information Display, insert the CD.
3. Repeat steps 1 and 2 until up to 6 CDs are loaded.

### To Change Music CD

Push the DISC button (▲ or ▼) during playback.

### To Change MP3/WMA CD

Push the DISC button (▲ or ▼) for 1.5 seconds or more during playback.

#### • Auto-Memory Tuning

Push and hold the AUTO-M button to store an additional 6 stations on each FM and AM band without disturbing the previously stored stations. This is especially useful when driving in an area where the local stations are not known. To return to previously stored stations, push the FM or AM button. Refer to the Owner's Manual for complete details.

#### FOLDER SEARCH (during MP3/WMA CD playback)

- To change to the previous folder, push the folder down button (▼) for less than 1.5 seconds, or push the folder up button (▲) for less than 1.5 seconds to advance to the next folder.

#### AUDIO DISPLAY FUNCTIONS

- Clock
- Audio
- Bluetooth® Hands-Free

#### BLUETOOTH®



When available, the audio display shows:

- TELEPHONE NUMBERS
- BLUETOOTH® HANDS-FREE MESSAGES
- OPERATION STATUS

## PAIRING YOUR BLUETOOTH® PHONE

### NOTE:

- For safety reasons, you cannot pair a phone while driving.
- Before pairing your cell phone, you must manually turn on the Bluetooth® function on the device. Refer to your device's Bluetooth® for steps to turn on Bluetooth®.
- **For customer service and device compatibility:**  
**Toll-free call: 800-430-0153**  
**Website: [www.MazdaUSA.com/bluetooth](http://www.MazdaUSA.com/bluetooth)**
- **IMPORTANT:** Set the volume level on your cell phone to the highest level before distortion starts, then adjust the volume on the vehicle's audio system.
- When in range of another Wi-Fi device, the Bluetooth connection between your phone and the system may disconnect for a short time if you have Wi-Fi enabled. Turn off Wi-Fi on your phone if needed.

- 1 Manually turn Bluetooth on your phone.
- 2 Activate the Bluetooth® application of the mobile telephone.
- 3 Push button /  located on steering wheel.
- 4 After the beep say, **"Setup"**.
- 5 After the beep, say, **"Pairing options"**.
- 6 After the beep, say, **"Pair a Phone"**.
- 7 After the beep, say any 4-digit code.
- 8 The prompt will repeat the number and ask if it is correct. After the beep, say, **"Yes"** or **"No"**. If no, the system will repeat the process.
- 9 Use your phone's manual for instructions on how to proceed.
- 10 Input the 4-digit code.
- 11 Name your phone, for example, **"Heather's Phone"**.
- 12 The prompt will confirm the name. After the beep say, **"Yes"** or **"No"**.
- 13 After the beep say a priority number between 1 and 7. 1 being the phone used most often.
- 14 The prompt will confirm the priority number. After the beep say, **"Yes"** or **"No"**.
- 15 Pairing is complete.

**NOTE:** Please refer to your Owner's Manual for complete details on how to "pair" up to 7 Bluetooth® phones, and how to use the built-in tutorial and other important safety information.

## TO MAKE OR RECEIVE A HANDS-FREE CALL

### Basic Operation:

/  **button:** Short press to receive/swap a call.

/  **button:** Short press to skip voice guidance (for speeding up operation).

/  **button:** Long press (press and hold) to end/reject a call.





## ***MYMAZDA.COM—THE OFFICIAL SITE FOR MAZDA OWNERS***

Register today on MyMazda.com—the ultimate destination for Mazda Owners. Once registered, you'll be able to take advantage of benefits exclusively for Mazda Owners:

- Insider access to exclusive events and promotions
- Personalized maintenance schedules
- Zoom-Zoom Owner Magazine
- Warranty information and on-line Owner's Manuals
- Wallpaper, videos and other fun stuff
- Accessories specifically designed for your vehicle
- Car Care Discount Coupons available from your Authorized Mazda Dealer

**Visit and register at MyMazda.com today!**

### **MAZDA MOBILE**

The following apps are available for iPhone® and Android smartphones:

- **Mazda Assist app** - Provides roadside assistance 24 hours a day, 365 days a year. Toll free number 1-800-866-1998 can also be used for roadside assistance.
- **MyMazda app** - Keep track of your Mazda from the palm of your hand with these features:
  - Maintenance schedule
  - Service coupons
  - Promotional alerts
  - Service history
  - Recall information
  - Parked car locator
  - Scan VIN barcode capability when registering a vehicle
  - Mazda Dealer locator
  - Update owner profile
  - Link to Mazda Assist

The apps can be downloaded, free of charge, from the App store for the iPhone and Google Play (Android Market) for Android powered devices. After downloading app, customer name, email, smartphone number and VIN are required.



**Free Mazda Assist app  
iPhone and Android**



**Free MyMazda app  
iPhone and Android**

# Customer Delivery Checklist

## VEHICLE PRESENTATION:

Refer to the Smart Start Guide during presentation

### Keyless Entry .....1-2



- Advanced Key\*
- Door Request Switch\*
- Trunk Request Switch\*
- Keyless Entry Transmitter

### Starting the Engine.....2

- Start Knob Ignition (Advanced Key\*)

### Seats .....3

- Adjustment
- Heated Seats\*
- Behind Seat Storage\*

### Fuel Door Release .....4

### Driver's View ..... 5-6

- Location of Switches and Controls
- Trunk Lid Release Button

### Instrument Cluster ..... 7-8

- Indicator light function and location
- INFO Button (Fuel Mileage)

### Lights .....9



### Wiper/Washer.....10



### AUX Jack .....12

### Flat Tire ..... 14

- Instant Mobility System (IMS) located in trunk

### Convertible Top ..... 15-20

- Manual Convertible Top
- Manual Convertible Top Maintenance
- Power Retractable Hardtop

### Climate Control..... 21-22

- Manual Controls
- AUTO Controls
- Vent Operation



### Set Clock ..... 23

### Audio Controls ..... 23-24

- SIRIUS Radio® Operation and Activation

### Bluetooth® Hands-Free\* ..... 25

- Pair Phone
- Make a Call
- Toll-Free Customer Service  
**800-430-0153**

## SCHEDULED MAINTENANCE

When replacing or topping off engine oil, use Mazda Genuine oil. For optimal engine performance, use SAE 0W-20 engine oil. Please consult an Authorized Mazda Dealer for additional information.

*\*if equipped*

**All items in the Customer Delivery Checklist have been reviewed with the customer and the first maintenance appointment has been scheduled:**

SALES CONSULTANT	DATE	CUSTOMER	DATE

Signed copy must be placed in dealer jacket

# Customer Delivery Checklist

<b>DEALERSHIP</b>	<b>DATE</b>
<b>SALES CONSULTANT</b>	<b>CUSTOMER'S NAME</b>
<b>VIN</b>	<b>E-MAIL</b>

## PRESENTATION OF OWNER'S MATERIALS:

*Review the following items with the customer*

### Smart Start Guide

- Remove this checklist from Smart Start Guide
- Personalization Features (refer to your Owner's Manual)

### Warranty Information

**Warranty Start Date:** \_\_\_\_\_

**Customer Initial:** \_\_\_\_\_

- Basic Vehicle – 36 months/36,000 miles
- Roadside assistance program

### MyMazda.com

- Offer to register customer on MyMazda.com

### Owner's Manual

### Maintenance Passport

### Floor Mats

- Ensure floor mats are properly hooked after cleaning
- Do not install two floor mats, one on top of the other, on the driver side
- Accessory rubber floor mats should be cleaned with mild soap and water only

## SERVICE DEPARTMENT

- Introduce Service Manager; provide business cards
- Review Service and Parts Department hours of operation
- Explain free Full Circle Service Inspection
- Schedule first maintenance service



## GENUINE MAZDA SERVICE

***Because you and your Mazda deserve the best***

Your new Mazda deserves nothing less than the very best. To keep it running like new for years to come, trust the experts at your local Authorized Mazda Dealer. Simply bring your vehicle in for your scheduled maintenance and any needed repairs.\*

At participating Mazda Full Circle Service Centers,\*\* our technicians will automatically perform a complimentary Full Circle inspection on your vehicle and issue a detailed report card at every visit. This is designed to help you keep track of your Mazda's critical operating condition. Our factory-trained technicians know your vehicle inside and out, and use Genuine Mazda Parts, giving your vehicle the optimum care and maintenance it requires to run with flawless precision.

Remember, to further enhance your driving experience, visit your local Mazda Service Center for your scheduled maintenance. It's also the place where you can find a wide variety of tires, parts, and accessories that are just right for your vehicle.

\* See vehicle's scheduled-maintenance program for details.

\*\* Visit the Mazda Owners website at [MyMazda.com/fullcircle](http://MyMazda.com/fullcircle) to find a participating Mazda Full Circle Service Dealer.

**Customer Experience Center: 1-800-222-5500**

**Roadside Assistance Contact: 1-800-866-1998**

*Mazda*  
**FULL CIRCLE**  
*SERVICE*

### FREE FULL CIRCLE SERVICE INSPECTION

***We're committed to providing  
expert Mazda service.***

You love to drive your Mazda, and we love to service your Mazda. With our Full Circle Service, we'll give your vehicle a COMPLIMENTARY MULTI-POINT INSPECTION. Your Mazda will receive a thorough review of its most crucial components.

This easy-to-use Smart Start Guide is intended to help you more fully appreciate some of the unique features and functions of your new vehicle. However, it is not intended to replace your Owner's Manual. The Owner's Manual contains more detailed information to help you better understand the important safety warnings, features, operation, and maintenance of your vehicle. All information, specifications, photographs and illustrations in this publication are those in effect at the time of printing. Mazda reserves the right to change specifications or design without obligation.

© Mazda North American Operations  
Printed in U.S.A. 04/14  
Print 1  
9999 95 031C 15SS



[www.MazdaUSA.com](http://www.MazdaUSA.com)